

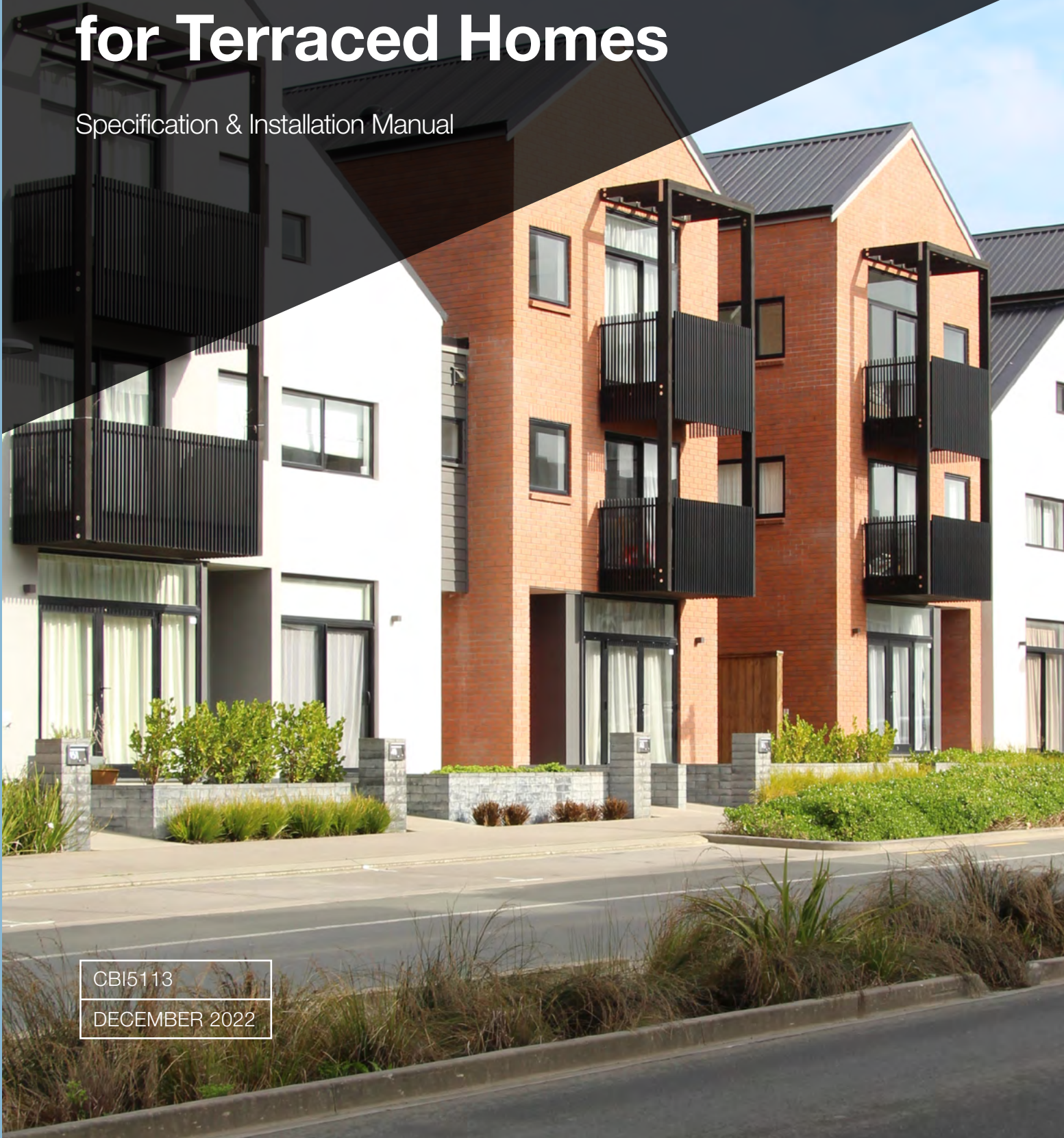

Intertenancy Barrier Systems for Terraced Homes

Specification & Installation Manual



CBI5113

DECEMBER 2022

NATIONAL SUPPORT

VISIT: Winstone Wallboards Limited
37 Felix Street, Penrose,
Auckland 1061, New Zealand

POST: PO Box 12 256, Penrose,
Auckland 1642, New Zealand

PHONE: +64 9 633 0100

EMAIL: info@gib.co.nz

WEB: gib.co.nz

GIB® HELPLINE

0800 100 442

This document is intended for Terraced Housing. GIB® Intertenancy Barrier Systems for Terraced Homes provide peace of mind, delivering fire, noise and security performance.

BENEFITS OF THE GIB® INTERTENANCY BARRIER SYSTEMS INCLUDE:

- High fire protection and noise control performance.
- No acoustic or fire sealing required where services penetrate wall linings within limitations.
- Cost effective.
- Narrow footprint, maximise the available tenancy of each unit.
- Options for timber and steel framing.
- Lightweight construction, no need for specific foundation designs.
- Easy and fast to install, no additional trades required for installation.

GIB® INTERTENANCY BARRIER SYSTEMS

GIB Barrierline® sheets include a water and mould resistant core. Despite this it is important to remember that paper-faced gypsum plasterboard should only be handled when dry. Therefore GIB Barrierline®, GIB Weatherline® and GIB Fyrelite® sheets must be kept dry after delivery and before installation.

Once installed GIB Barrierline®, GIB Weatherline® and GIB Fyrelite® sheets can be exposed to the elements before the building is closed in for the following maximum time periods:

- GIB Barrierline®: 12 weeks
- GIB Weatherline®*: 12 weeks
- GIB Fyrelite®: 4 weeks

* when used in GIB® Intertenancy Barrier Systems

GIB® Intertenancy Barrier Systems

Winstone Wallboards Ltd accepts no liability if the GIB® Intertenancy Barrier Systems are not designed and installed in strict accordance with instructions contained in this publication.

USE ONLY THE CURRENT SPECIFICATION

This publication may be superseded by a new publication. Winstone Wallboards accepts no liability for reliance upon publications that have been superseded. You should check the current index of publications contained in your GIB® Technical Manual before using this publication. If you are unsure whether this is the current publication, simply call the GIB® Helpline on 0800 100 442.

Timber Frame Walls - with GIB Barrierline® Central Barrier					
Specification	STC	Rw	FRR	Lining requirements	Page
GBTLAB 60a	68	66	60/60/60	2 x 10mm GIB® Standard each side	16
GBTLAB 60b	64	63	60/60/60	1 x 10mm GIB Braceline® GIB Noiseline® each side	18
GBTLAB 60c	67	65	60/60/60	1 x 13mm GIB Braceline® GIB Noiseline® each side	20
GBTLAB 60d	61	60	60/60/60	1 x 13mm GIB® Standard each side	22

Steel Frame Walls - with GIB Barrierline® Central Barrier					
Specification	STC	Rw	FRR	Lining requirements	Page
GBSLAB 60a	61	60	60/60/60	1 x 13mm GIB® Standard each side	24
GBSLAB 60b	67	65	60/60/60	1 x 13mm GIB Braceline® GIB Noiseline® each side	26

FIGURE 1: GIB® INTERTENANCY BARRIER SYSTEM FOR TERRACE HOMES

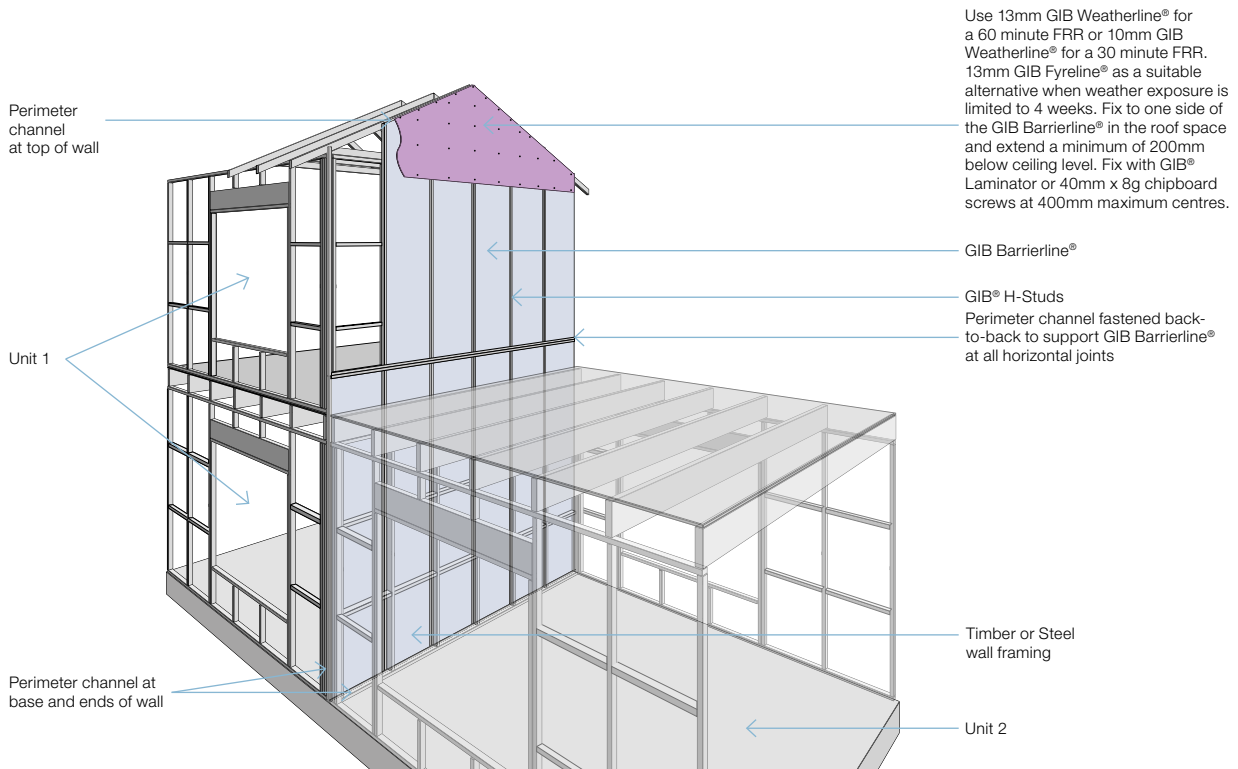

Specification reference example

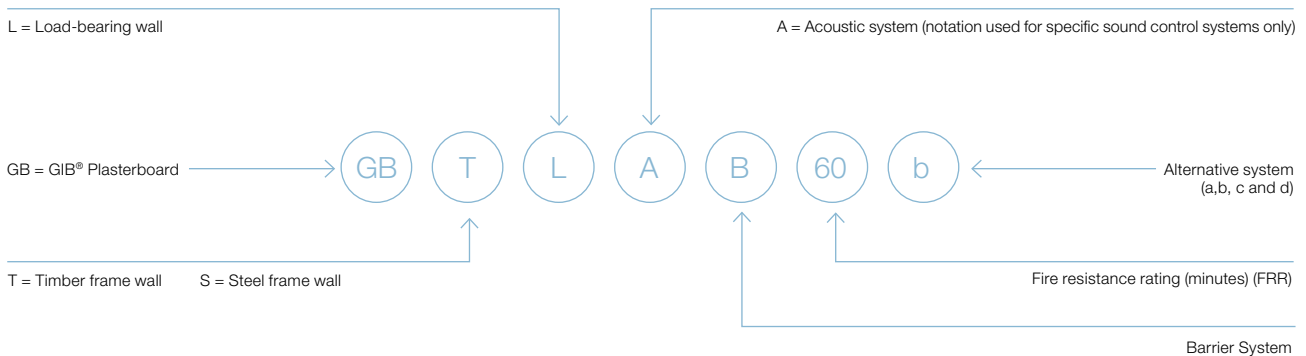

Scope of use

GIB® Intertenancy Barrier Systems are designed to provide a NZBC compliant separating wall between attached dwellings. The system consists of a double timber or steel frame wall with a 25mm thick plasterboard barrier between the frames. The primary fire resistance is provided by the plasterboard barrier, with the wall linings contributing to some extent. This allows the wall linings to be used for structural bracing and to incorporate penetrations.

The basis of the acoustic performance is a double cavity system. This provides isolation from airborne sound. Insulation in both cavities is used to meet various performance levels and allows certain services to penetrate the wall linings.

Beware of substitution

The performance of GIB® Systems are very sensitive to design detailing and construction practices. All GIB® Systems have been developed specifically for New Zealand conditions and independently tested or assessed to ensure the required level of performance. It is important to use only GIB® branded components where specified and to closely follow the specified design details and construction practices, to be confident that the required level of performance and quality is achieved on site.

For further information call our GIB® Helpline on 0800 100 442.

GIB® Intertenancy Barrier Systems have been designed and tested using only the products specified. For permitted bracing substitutions see the latest version of the GIB EzyBrace® Systems literature.

Compliance with the NZ Building Code

NZBC CLAUSE B1 – STRUCTURE

The design and material specification for timber and steel framing used in conjunction with this literature must be in accordance with the performance requirements of NZBC Clause B1.

Acceptable Solution B1/AS1 cites the following relevant documents.

- NZS 3604:2011 Timber-framed buildings
- NASH Standard Part 2: May 2019 Light Steel Framed Buildings

Alternatively specific engineering design must comply with Verification Method B1/VM1

NZBC CLAUSE B2 – DURABILITY

Under normal conditions of dry internal use the products detailed in GIB® Intertenancy Barrier Systems have a service life in excess of 50 years and satisfy the requirements of NZBC Clause B2. When in conditions of dry internal use, the components specified in this literature satisfy the requirements of NZBC Clause B2.

* Otherwise components must comply with acceptable solution B2/AS1

NZBC CLAUSES C1-C6 – PROTECTION FROM FIRE

GIB® Intertenancy Barrier Systems can be used to provide passive fire protection in accordance with the requirements of NZBC Clauses C1-C6 – Protection from Fire.

NZBC CLAUSE F2 – HAZARDOUS BUILDING MATERIALS

Under normal conditions of use and serviceable life, the products detailed in the GIB® Intertenancy Barrier Systems do not constitute a health hazard and meet the provisions of the NZBC Clause F2.

NZBC CLAUSE G6 – AIRBORNE AND IMPACT SOUND

GIB® Intertenancy Barrier Systems for Terrace Homes provide airborne noise control ratings that exceed the minimum requirements of NZBC Clause G6 – Airborne and Impact Sound.

Appraisal

GIB® Intertenancy Barrier Systems for Terraced Homes have been appraised by the Building Research Association of New Zealand (BRANZ), Appraisal No. 940 (2022).

It is of prime importance to comply with the details of design, construction and workmanship in this document.

Building design

GIB® Intertenancy Barrier Systems consist of vertically spanning elements extending from the ground slab or footing up to the roof. Consideration of roof framing is also important to avoid penetrating the barrier with trusses, ties, hip beams, etc.

GIB® Intertenancy Barrier Systems are ideally suited to buildings with aligned external facades. A detail for an off-set façade is provided.

The maximum height for GIB® Intertenancy Barrier Systems in terraced homes is 12m.

Structural design

Timber framing shall be in accordance with NZBC B1 Structure – B1/AS1 Clause 3.0 Timber – NZS 3604 or Verification Method B1/VM1.

Steel framing shall be in accordance with NZBC B1 Structure – B1/AS1 Clause 9.1 National Association of Steel Framed Housing Inc (NASH) – NASH Standard Part 2: May 2019 Light Steel Framed Buildings or Verification Method B1/VM1.

GIB® H-Studs form the vertical joints between sheets of GIB Barrierline®. They must be continuous lengths and be fitted into the GIB® Rondo® 140 Perimeter Channel at their top and bottom. No mechanical fixings are required between the GIB® H-Stud and the channels, or the GIB® H-Stud and the GIB Barrierline®.

GIB® Wall Clips provide lateral support to the central barrier and are required within 600mm below the top of every GIB® H-Stud, on both sides, and at 3000mm maximum centres vertically.

GIB BARRIERLINE® WALL HEIGHTS

GIB Barrierline® sheets are produced in 3000mm lengths which are installed vertically. If wall heights of 3300mm or 3600mm are required to reach the roof or soffit line a 300mm or 600mm GIB Barrierline® strip may be laid horizontally into the bottom perimeter channel to provide additional height.

The bottom strip is capped with a GIB® Rondo® 140 perimeter channel fixed to wall framing with GIB® wall clips at 600 mm centres. A second perimeter channel is fixed back to back at 600mm centres.

GIB Barrierline® sheets can then be installed vertically on top of the horizontal strip.



Scan this QR Code to see a GIB® Video of the installation process.

FIGURE 2: TYPICAL LOCATIONS OF INTERTENANCY WALLS

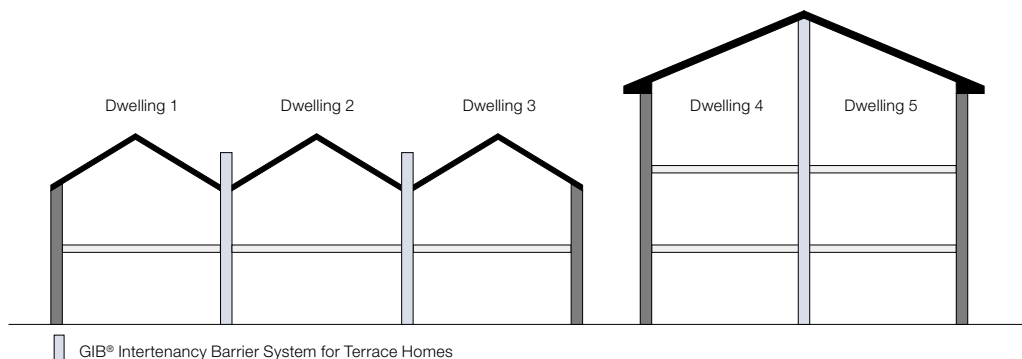

Fire resistance

The GIB® Intertenancy Barrier Systems in this document are suitable for the stated Fire Resistance Rating (FRR) when designed in accordance with the building and structural considerations on the previous page, and installed in accordance with the details in this manual.

GIB® Intertenancy Barrier Systems are designed for one side to collapse in a fire, leaving the central barrier and the opposing wall in place. The GIB® Wall Clips are designed to melt in a fire-affected unit to detach whilst leaving the central barrier attached to the framing of the adjacent wall.

The contribution of the units linings ensure that the published FRR is achieved.

In the roofspace to maintain a 60 minute FRR 13mm GIB Weatherline® or 13mm GIB Fyreline® is to be laminated to the GIB Barrierline®. In applications requiring a 30 minute FRR a layer of 10mm GIB Weatherline® or 13mm GIB Fyreline® is required.

Noise control performance

The noise control performance of GIB® Intertenancy Barrier Systems are expressed in terms of Sound Transmission Class (STC) and Weighted Sound Reduction Index (Rw). The ratings are based on tested laboratory performance. The site performance of the system may be affected by sound flanking, workmanship and the inclusion of structural and bridging elements. The building designer must pay special attention to airborne and structural flanking paths to minimise the difference between laboratory and field performance.

GIB® Wall Clips are only to be installed as shown in the details. Using additional clips within the storey height can reduce the acoustic performance of the wall.

For flanking sound control it is required that each storey ceiling consists of 13mm GIB® plasterboard. To further improve flanking sound control it is optional to install fibrous insulation, such as Pink® Batts® (115mm) ceiling, in the ceiling cavity. The optional insulation should extend 1200mm minimum on each side of the wall over the ceiling.

It is assumed no noise control rating is required between the two adjoining roof spaces and that the spaces are not occupied.

The GIB Barrierline® systems in this manual provide noise attenuation well in excess of NZBC requirements. Potential noise flanking via rigid facade connections and exterior joinery are unlikely to affect NZBC compliance, however, it is important to minimise flanking paths via the surrounding structure to achieve satisfactory on-site performance.

Durability during construction

GIB Barrierline® sheets have a water and mould resistant core. Despite this, it is important to remember that paper-faced gypsum plasterboard should only be handled when dry and must be kept dry after delivery and before installation. Reusable waterproof covers can be supplied with all deliveries of GIB® Intertenancy Barrier System components, including GIB Barrierline®.

Leave a 5mm gap between length of bottom perimeter channel. This will let any collected rain water escape more readily. Once installed GIB Barrierline®, GIB Weatherline® and GIB Fyreline® sheets can be exposed to the elements before the building is closed in for the following maximum time periods*:

- GIB Barrierline®: 12 weeks
- GIB Weatherline®: 12 weeks*
- GIB Fyreline®: 4 weeks

* When used in GIB® Intertenancy Barrier Systems.

Security

The presence of the central barrier provides added security. The 25mm thick GIB Barrierline® with galvanised steel GIB® H-Studs at the sheet joints forms a secure separation in the centre of the intertenancy wall.

Quality of finish

For timber frame buildings GIB® Intertenancy Barrier System specification number GBTLAB 60a minimises the possibility of surface imperfections by reducing the number of fasteners used to fix the outer layer wall lining in timber frame buildings due to the outer layer being fixed with both adhesive and fasteners.

Building services

GIB® Intertency Barrier Systems allow installation of plumbing and electrical services in the cavities either side of the central barrier. Back-to-back services and penetrations are permitted within the limitations given below. A minimum of 10 mm clearance must be provided between plumbing or electrical services and the central barrier.

Plumbing services up to 65 mm in diameter and electrical services up to 90 x 50 mm do not need specialist fire-stopping where they penetrate the wall linings. The maximum number of unprotected service penetration is limited to two per nominally 600 mm wide framing cavity. Plumbing service penetrations through wall linings must have neatly cut holes with 6 mm maximum clearance around the plumbing service. Fill the gap with a general purpose flexible sealant.

Suitable proprietary fire-stopping is required for wall lining penetrations larger than 90 x 50 mm or 65 mm in diameter, and for penetrations through the GIB Barrierline® core in the roof space.

FIGURE 3: TYPICAL PENETRATION FEATURES

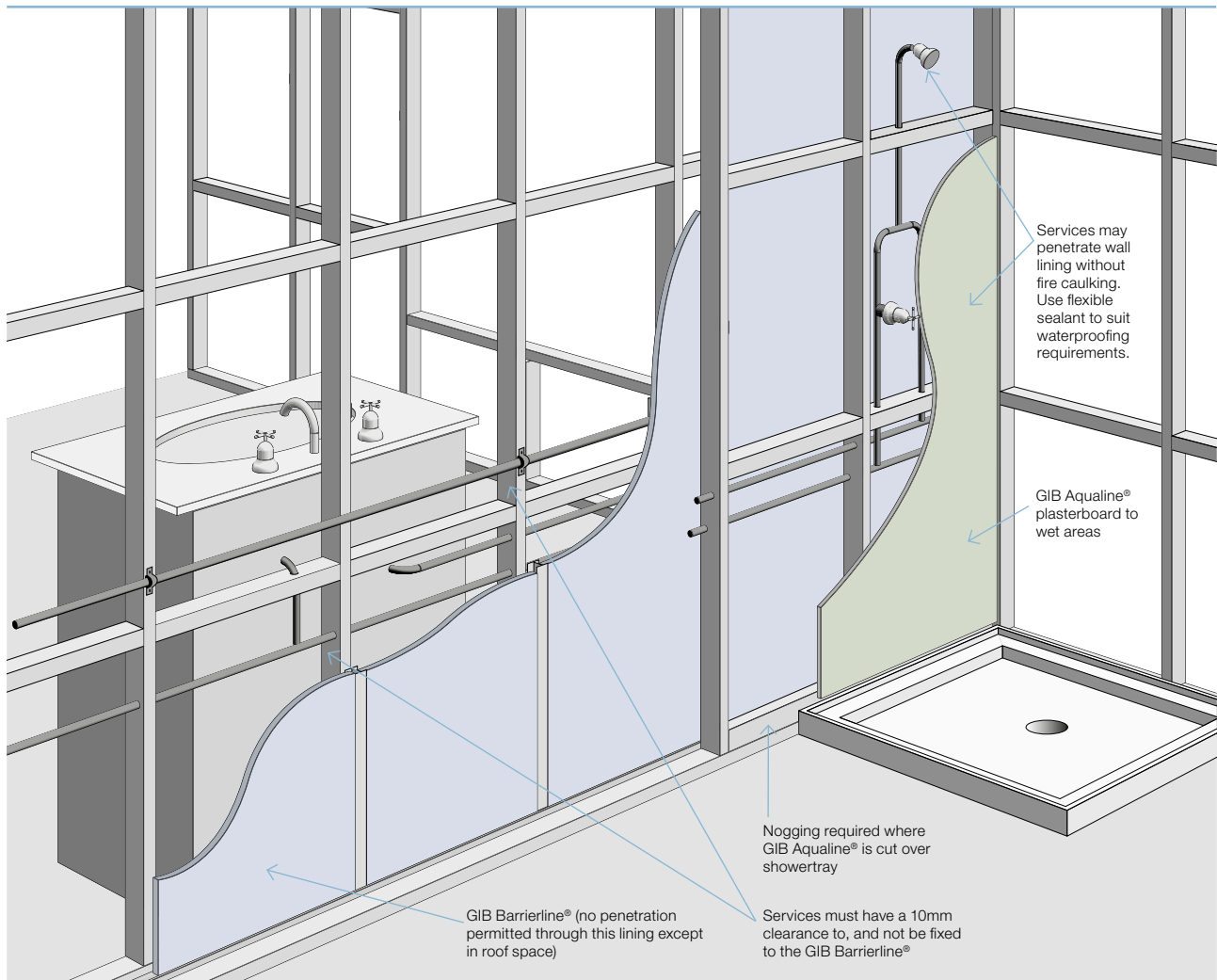

Linings

GIB® Plasterboard	Use	Sheet Length (mm)	Sheet Width (mm)	Thickness (mm)	Max kg/m ²
GIB Barrierline®	Central Barrier Lining	3000	600	25	19.8
GIB® Standard	Unit Lining Options	2400-6000	1200	10	7
		2400-6000	1200	13	9
GIB Braceline®/ GIB Noiseline®		2400-4800	1200	10	9.3
		2400-3600	1200	13	12.5
GIB Weatherline®	Ceiling Space Wall Laminate	2450-3000	1200	10	9
		2750-3000	1200	13	11.5
GIB Fyreline®		2400-3600	1200	13	11.0

Components

Product	Use	Size (mm)	GIB® SKU Number	Suggested Qty per GIB Barrierline® Sheet
GIB® Rondo® 140 Perimeter Channel	Supports GIB Barrierline® at sheet top and bottom and wall ends	3000	14936	0.5
GIB® H-Stud	Supports GIB Barrierline® at vertical joints	3000	15618	1
GIB® Wall Clip	Provides lateral support to the GIB® H-Studs	40 x 90 x 50	15619	2
GIB® Wall Strap	Provides lateral support to the GIB® Rondo® 140 Perimeter Channel	110 x 30	15664	0.5
Exterior Fire and Acoustic Sealant	Sealant to one side of GIB® Rondo® 140 Perimeter Channel and floor slab		Suitable supplier	n/a

GIB® RONDO® 140 PERIMETER CHANNEL

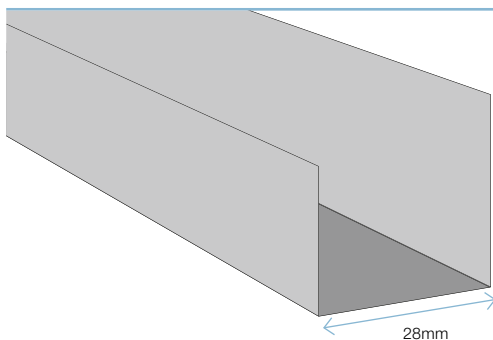

GIB® H-STUD

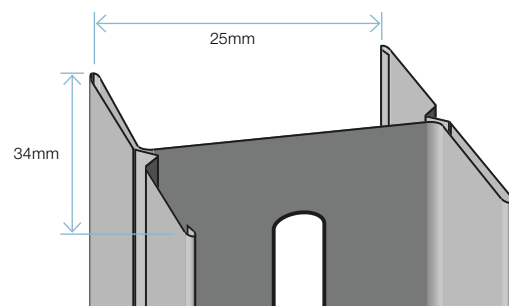

Fasteners

Fastener	Use	Supplier	Suggested Qty per GIB® Barrierline Sheet*
GIB® Laminator screws, 38mm x 10g Or Chipboard screws, 40mm x 8g	Fixing layer in roof space to GIB Barrierline®	GIB® (15758) Any Supplier	5
Drill-point wafer head screws, 16mm x 10g	Joining of metal components	Any	8
Drill-point wafer head screws, 30mm x 10g	Fixing GIB® Wall Clip to GIB® H-Stud through 13mm GIB Fyrelime®/GIB Weatherline®	Any	4
Wood screws, 25mm x 6g	Fixing metal components to timber	Any	6
Concrete Nails: 30mm x 3.5mm diameter or 25mm x 4.0 mm diameter. Or, Steel Expansion Anchors or Screw Anchors: 40mm x 6mm diameter	Fixing GIB® Rondo® 140 Perimeter Channel to concrete floor slab	Any	n/a

* Quantities are an indicative guide for accessory ordering purposes.

Insulation

Product	Use	Supplier
Pink® Batts® R2.2 (90mm) glass wool Insulation	Installed between the studs and nogs in both wall frames	Pink® Batts®*
Mineral Wool or Ceramic Fibre Cavity Insulation	Installed to seal the top of the GIB Barrierline® wall. Thickness to match cavity. Minimum density 40kg/m ³ .	Any

*or refer to online GIB Noise Control® Systems Supplement for additional options

Weather Protection

GIB Barrierline®, GIB Fyrelime® and GIB Weatherline® sheets are required to be protected from weather on site prior to installation. Sheet pallets come by default shrink wrapped with a premium recyclable wrap and an additional charge to apply at the time of order placement. Alternatively reusable pallet covers may be purchased at the time of order placement (GIB® Sku 15651). For more information on pallet shrink wrapping or reusable pallet covers contact your merchant or GIB® Customer Services 0800 475 475.

GIB® WALL CLIP

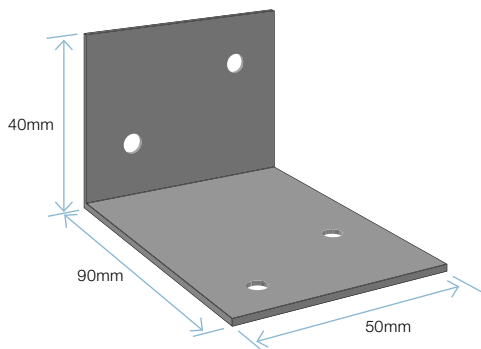

GIB® WALL STRAP

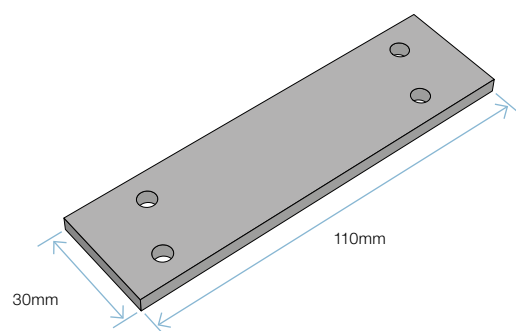

STEP 1
FIGURE 4 - GROUND FLOOR BARRIER INSTALLED

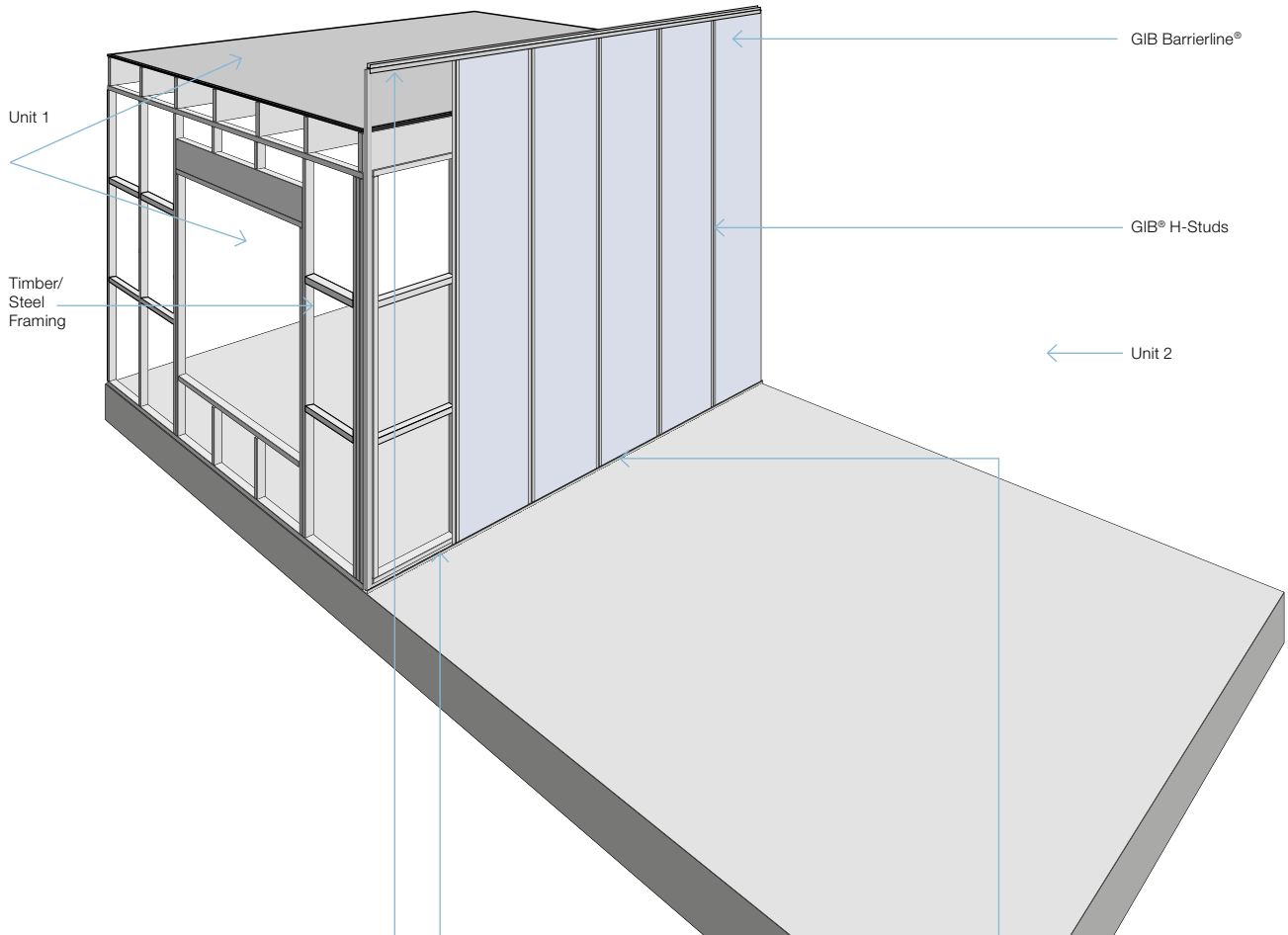

PERIMETER CHANNEL



- GIB® Rondo® 140 Perimeter Channel to base, ends and horizontal joints of GIB Barrierline®.
- Optional screw in wall corners to hold perimeter channels in place.
- Drill-point wafer head screws 16mm x 10g

FLOOR SLAB

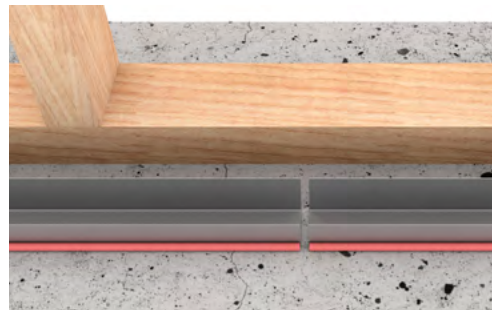

- Bead of exterior rated fire/acoustic sealant on one side at perimeter channel and floor slab.
- 5mm drainage gap between perimeter channels.



Scan this QR Code to see the construction sequencing of this GIB® detail.

STEP 2

FIGURE 5 - UNIT 2 FRAME AND FLOOR INSTALLED

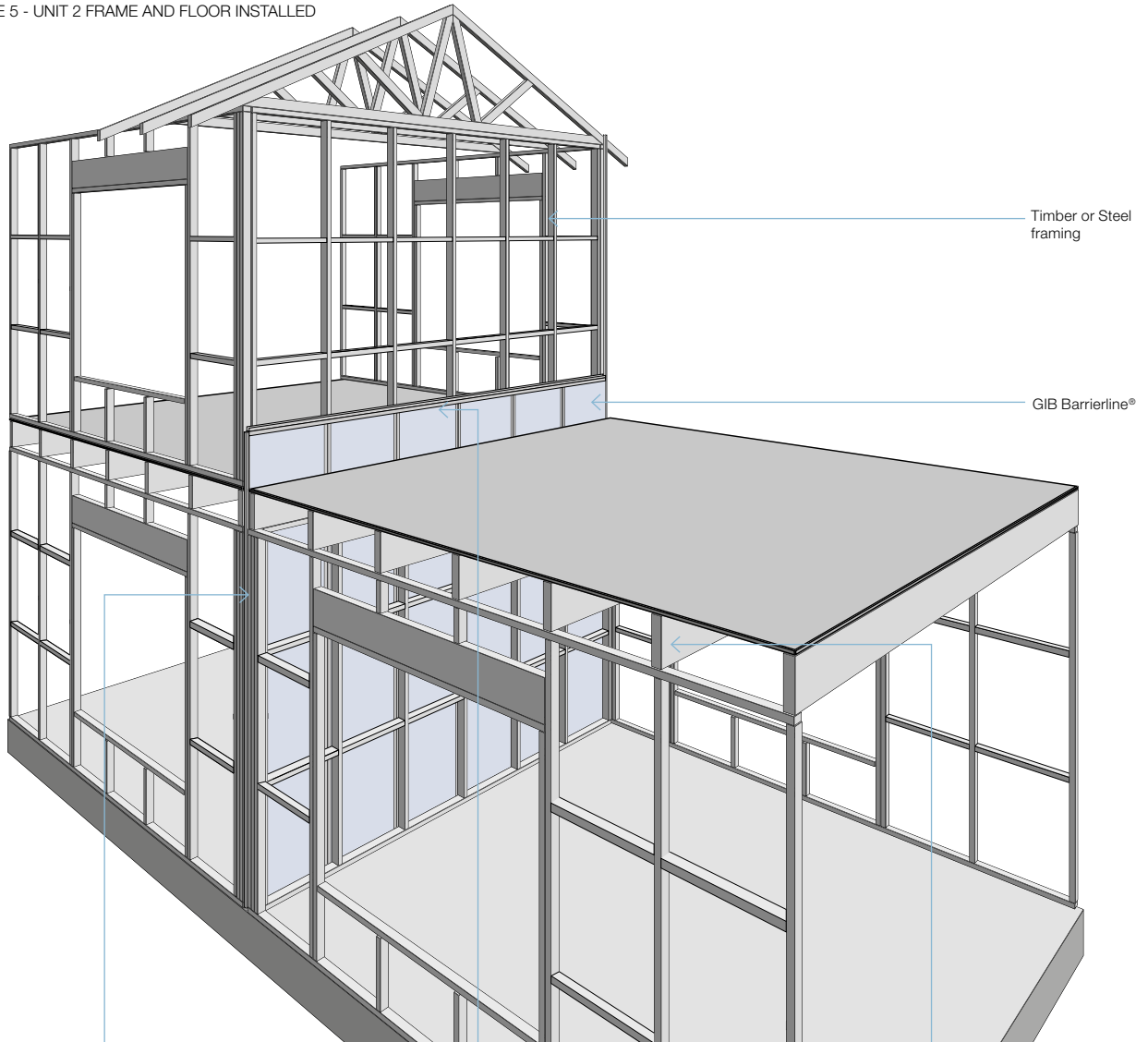

GIB® WALL STRAPS



- Use GIB® Wall Straps on the ends of the walls.

HORIZONTAL JOINTS



- GIB® Rondo® 140 Perimeter Channel fastened back to back to support GIB Barrierline® sheets at all horizontal joints.
- Drill-point wafer head screws 16mm x 10g.

GIB® WALL CLIPS



- GIB® Wall Clips attached to H-studs and framing



Scan this QR Code to see the construction sequencing of this GIB® detail.

STEP 3
FIGURE 6 - FIRST FLOOR BARRIER INSTALLED

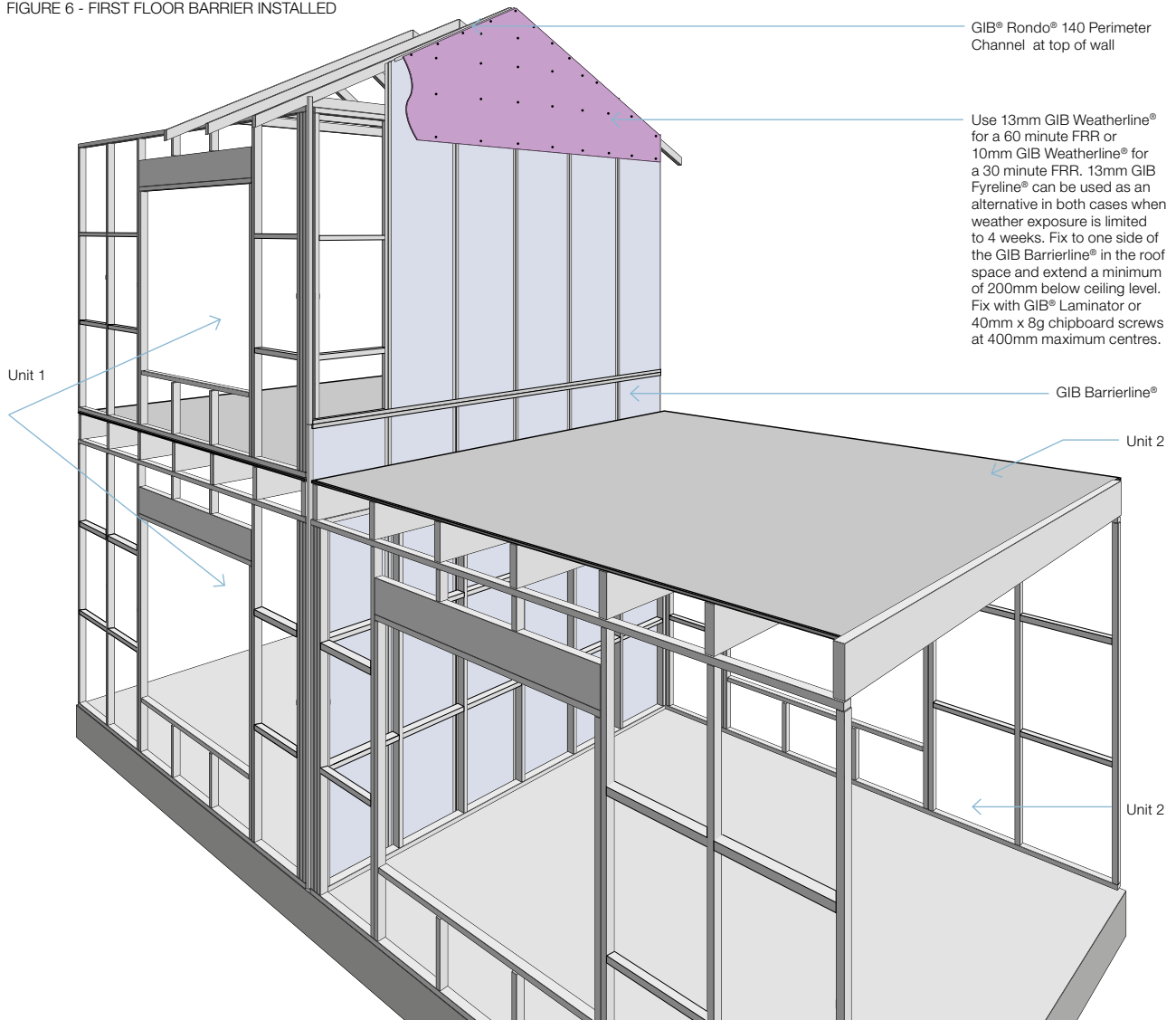

Scan this QR Code to see the construction sequencing of this GIB® detail.

STEP 4
FIGURE 7 - UNIT 2 FIRST FLOOR FRAMING INSTALLED

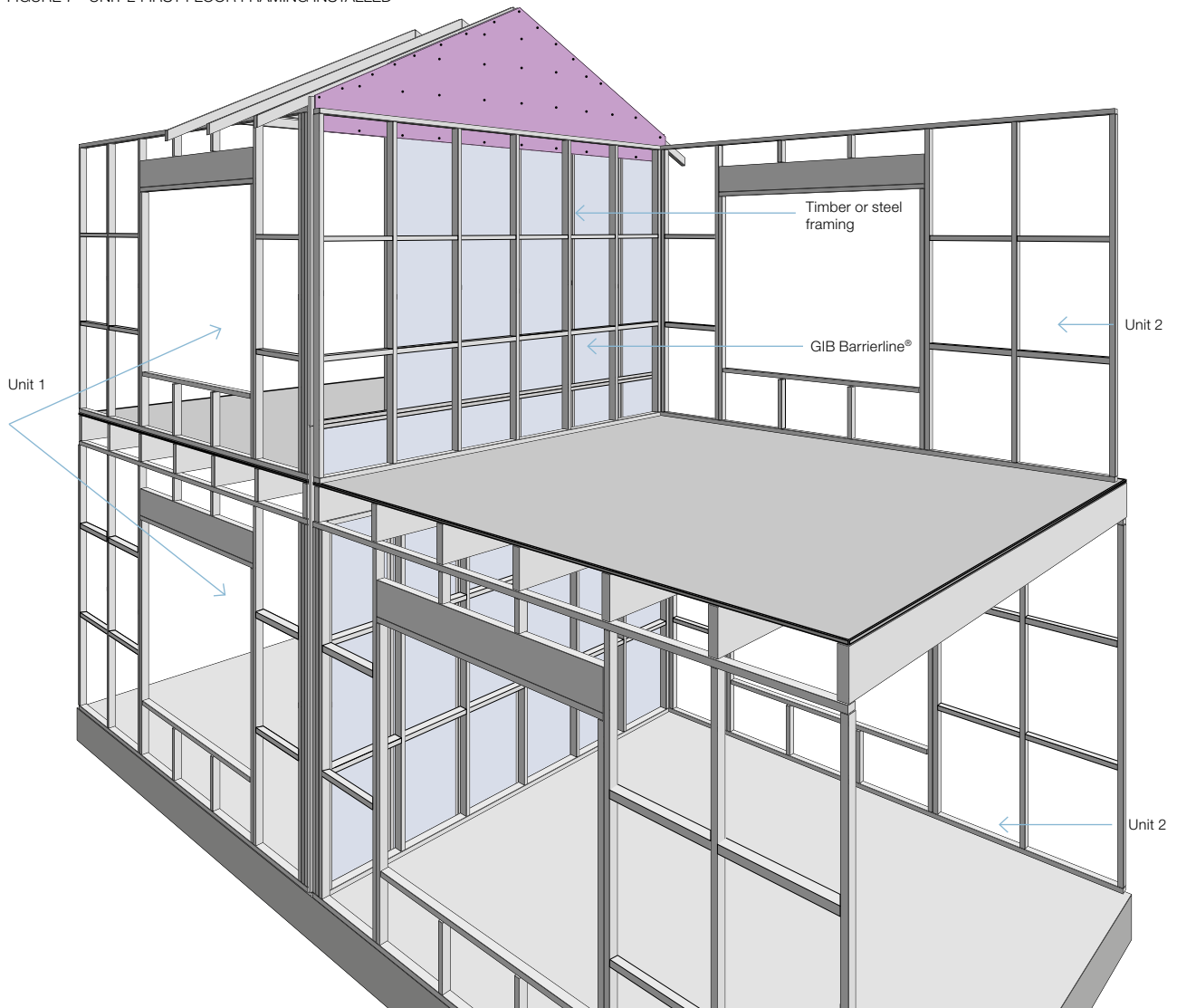

Scan this QR Code to see the construction sequencing of this GIB® detail.

Two way FRR – double timber frame with GIB Barrierline® central barrier

Specification number	Performance	Specifications
GBTLAB 60a	STC 68	Lining 2 x 10mm GIB® Standard each side
	Rw 66	LB/NLB Load bearing
	FRR 60/60/60	Partition 300–330mm wide

TIMBER FRAMING

Stud size	Space between frames
90mm	80–110mm

Framing to comply with:

- NZBC B1 – Structure: AS1 Clause 3 – Timber (NZS 3604) or VM1 Clause 6 – Timber (NZS 3603).
- NZBC B2 – Durability: AS1 Clause 3.2 – Timber (NZS 3602).

Maximum height as determined by NZS 3604 stud and top plate tables for load-bearing walls.

CENTRAL BARRIER

- Allow a 25–40mm gap between each timber frame and the GIB Barrierline® central barrier.
- Fix GIB® Rondo® 140 Perimeter Channels to the concrete floor with steel fasteners at 600mm centres and no more than 50mm from channel ends using 3.5mm x 30mm or 4.0mm x 25mm concrete nails or 6mm x 40mm concrete anchors.
- A 5mm gap between GIB® Rondo® 140 Perimeter Channels will let any collected rain water escape.
- GIB® Rondo® 140 Perimeter Channel to be sealed to the floor slab on one side with exterior fire/acoustic sealant.
- Install 25mm GIB Barrierline® into GIB® H-Studs at 600mm centres.
- Cap GIB Barrierline® ends with GIB® Rondo® 140 Perimeter Channel.
- Offset GIB® H-Studs from wall studs to allow attachment of GIB® Wall Clips to both frames. Nog as required where no framing exists.
- Place two GIB® Wall Clips (one each side) no more than 600mm below the top of each GIB® H-Stud, no further apart than 3000mm vertically.
- Fix GIB® Rondo® 140 Perimeter Channel at wall ends to both timber frames with GIB® Wall Clips or GIB® Wall Straps placed no further apart than 3000mm vertically.
- Use no more than two GIB® Wall Clips or GIB® Wall Straps (one each side) for each 3000mm length of GIB® H-Stud or GIB® Rondo® 140 Perimeter Channel.
- In the roof space, fix a 13mm GIB Weatherline® or 13mm GIB Fyreline® Laminate to one side of the GIB Barrierline® with GIB® Laminator Screws or 40mm x 8g chipboard screws on a 400mm grid, and at no more than 100mm from sheet edges.
- Extend the laminate at least 200mm below ceiling level
- Once erected, protect the GIB Barrierline® and laminate from rain. The use of suitable sheeting can avoid delays in allowing the board to dry before wall linings are installed.
- If the specification calls for a 30 minute FRR a 10mm GIB Weatherline® laminate can be used.

SOUND CONTROL INFILL

Install Pink® Batts® R2.2 (90mm) glass wool insulation between the studs and nogs in both frames.

WALL LINING

2 layers of 10mm GIB® Standard each side.

Fix inner sheets vertically. Where sheet end butt joints are unavoidable they must be formed over framing. Use full height sheets where possible.

Outer layer sheets can be fixed vertically or horizontally. If fixed vertically, outer layer sheet joints must be offset 600mm from those of the inner layer. Use full height sheets where possible.

If the wall lining forms part of the structural bracing system, the inner layer lining type and fixings must comply with the published bracing system. Check requirements for specific bracing element hold-down connections.

FASTENING THE LINING

Fasteners

Inner layer: 32mm x 6g GIB® Grabber® High Thread Drywall Screws.

Outer layer: 41mm x 6g GIB® Grabber® High Thread Drywall Screws.

Fastener centres

Fix inner layer sheets to each stud and plate with fasteners at 300mm centres. When fixing outer layer sheets vertically, offset sheet joints from the inner layer. Fix the perimeter of each outer layer sheet to the frame with fasteners at 300mm centres. Adhesive fix the outer layer to the inner layer with daubs of GIBFix® adhesive down the centre line at 300mm centres. Do not place GIBFix® adhesive at sheet edges or within 200mm of screw fixings.

If fixing outer layer sheets horizontally, fasteners to be placed at 300mm centres to top and bottom plates and perimeter studs. Install pairs of single fasteners to each stud where the horizontal joint crosses. Adhesive fix the outer layer to the inner layer with daubs of GIBFix® adhesive down the centre line at 300mm centres. Do not place GIBFix® adhesive at sheet edges or within 200mm of screw fixings. Place screws no closer than 12mm from paperbound sheet edges and 18mm from any sheet end or cut edge.

BUILDING SERVICE PENETRATIONS

GIB® Intertency Barrier Systems allow installation of plumbing and electrical services in the cavities either side of the central barrier. Back-to-back services and penetrations are permitted within the limitations given below. A minimum of 10 mm clearance must be provided between plumbing or electrical services and the central barrier.

Plumbing services up to 65 mm in diameter and electrical services up to 90 x 50 mm do not need specialist fire-stopping where they penetrate the wall linings. The maximum number of unprotected service penetration is limited to two per nominally

Two way FRR – double timber frame with GIB Barrierline® central barrier

Specification number	Performance	Specifications
GBTLAB 60a	STC 68	Lining 2 x 10mm GIB® Standard each side
	Rw 66	LB/NLB Load bearing
	FRR 60/60/60	Partition 300–330mm wide

600 mm wide framing cavity. Plumbing service penetrations through wall linings must have neatly cut holes with 6 mm maximum clearance around the plumbing service. Fill the gap with a general purpose flexible sealant.

Suitable proprietary fire-stopping is required for wall lining penetrations larger than 90 x 50 mm or 65 mm in diameter, and for penetrations through the GIB Barrierline® core in the roof space.

JOINTING

Central Barrier: Unstopped.

Inner layer wall lining: Unstopped.

Roof Laminate Layer: Unstopped.

Outer layer wall lining: All fastener heads stopped and all sheet joints tape reinforced and stopped in accordance with the publication entitled GIB® Site Guide. Wall to ceiling junctions are to be reinforced with paper tape and square stopped or finished with GIB-Cove®.

WET AREA WALL LINING

If the outer layer of 10mm GIB® Standard plasterboard wall lining is substituted with 10mm GIB Aqualine®, the FRR and noise control rating will be retained.

Place two GIB® Wall Clips (one each side) no more than 600mm below the top of each GIB® H-Stud, no further apart than 3000mm vertically
2 layers 10mm GIB® Standard Plasterboard

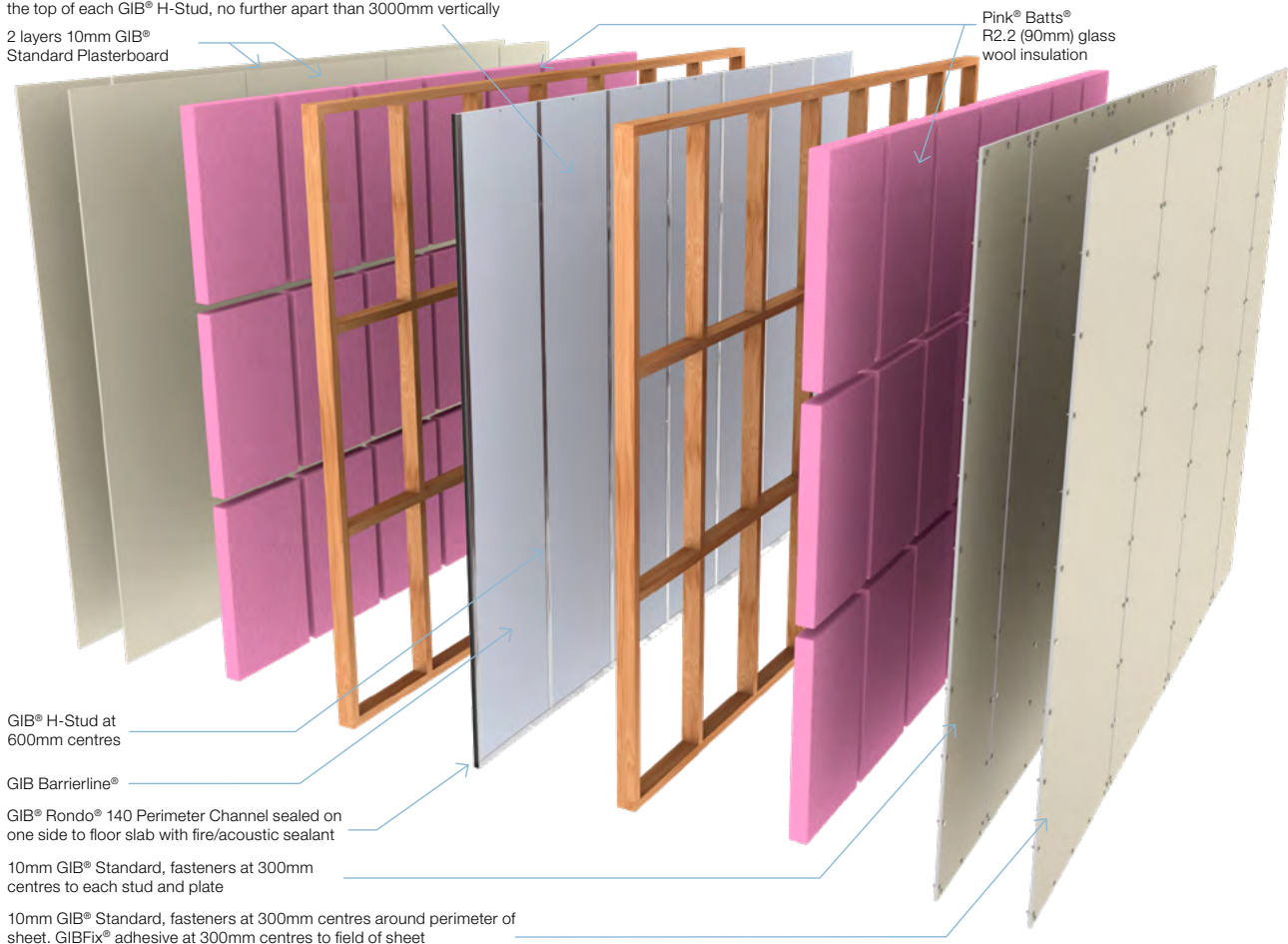

Two way FRR – double timber frame with GIB Barrierline® central barrier

Specification number	Performance	Specifications
GBTLAB 60b	STC 64 Rw 63 FRR 60/60/60	Lining 1 x 10mm GIB Braceline®/GIB Noiseline® each side LB/NLB Load bearing Partition 280–310mm wide

TIMBER FRAMING

Stud size	Space between frames
90mm	80–110mm

Framing to comply with:

- NZBC B1 – Structure: AS1 Clause 3 – Timber (NZS 3604) or VM1 Clause 6 – Timber (NZS 3603).
- NZBC B2 – Durability: AS1 Clause 3.2 – Timber (NZS 3602).

Maximum height as determined by NZS 3604 stud and top plate tables for load-bearing walls.

CENTRAL BARRIER

- Allow a 25–40mm gap between each timber frame and the GIB Barrierline® central barrier.
- Fix GIB® Rondo® 140 Perimeter Channels to the concrete floor with steel fasteners at 600mm centres and no more than 50mm from channel ends using 3.5mm x 30mm or 4.0mm x 25mm concrete nails or 6mm x 40mm concrete anchors.
- A 5mm gap between GIB® Rondo® 140 Perimeter Channels will let any collected rain water escape.
- GIB® Rondo® 140 Perimeter Channel to be sealed to the floor slab on one side with exterior fire/acoustic sealant.
- Install 25mm GIB Barrierline® into GIB® H-Studs at 600mm centres.
- Cap GIB Barrierline® ends with GIB® Rondo® 140 Perimeter Channel.
- Offset GIB® H-Studs from wall studs to allow attachment of GIB® Wall Clips to both frames. Nog as required where no framing exists.
- Place two GIB® Wall Clips (one each side) no more than 600mm below the top of each GIB® H-Stud, no further apart than 3000mm vertically.
- Fix GIB® Rondo® 140 Perimeter Channel at wall ends to both timber frames with GIB® Wall Clips or GIB® Wall Straps placed no further apart than 3000mm vertically.
- Use no more than two GIB® Wall Clips or GIB® Wall Straps (one each side) for each 3000mm length of GIB® H-Stud or GIB® Rondo® 140 Perimeter Channel.
- In the roof space, fix a 13mm GIB Weatherline® or 13mm GIB Fyreline® Laminate to one side of the GIB Barrierline® with GIB® Laminator Screws or 40mm x 8g chipboard screws on a 400mm grid, and at no more than 100mm from sheet edges.
- Extend the laminate at least 200mm below ceiling level.
- Once erected, protect the GIB Barrierline® and laminate from rain. The use of suitable sheeting can avoid delays in allowing the board to dry before wall linings are installed.
- If the specification calls for a 30 minute FRR a 10mm GIB Weatherline® laminate can be used.

SOUND CONTROL INFILL

Install Pink® Batts® R2.2 (90mm) glass wool insulation between the studs and nogs in both frames.

WALL LINING

A single layer of 10mm GIB Braceline®/GIB Noiseline® fixed vertically or horizontally.

Use full height sheets where possible.

Sheet joints are touch fitted and must occur over framing. Where sheet end butt joints are unavoidable they must be formed over framing.

If the wall lining forms part of the structural bracing system, the lining type and fixings must comply with the published bracing system. Check requirements for specific bracing element hold-down connections.

FASTENING THE LINING

Fasteners

32mm x 6g GIB® Grabber® High Thread Drywall Screws.

Fastener centres

300mm centres to each stud, plate and sheet edge. Place screws no closer than 12mm from paperbound edges and 18mm from any sheet end or cut edges.

BUILDING SERVICE PENETRATIONS

GIB® Intertenancy Barrier Systems allow installation of plumbing and electrical services in the cavities either side of the central barrier. Back-to-back services and penetrations are permitted within the limitations given below. A minimum of 10 mm clearance must be provided between plumbing or electrical services and the central barrier.

Plumbing services up to 65 mm in diameter and electrical services up to 90 x 50 mm do not need specialist fire-stopping where they penetrate the wall linings. The maximum number of unprotected service penetration is limited to two per nominally 600 mm wide framing cavity. Plumbing service penetrations through wall linings must have neatly cut holes with 6 mm maximum clearance around the plumbing service. Fill the gap with a general purpose flexible sealant.

Suitable proprietary fire-stopping is required for wall lining penetrations larger than 90 x 50 mm or 65 mm in diameter, and for penetrations through the GIB Barrierline® core in the roof space.

Two way FRR – double timber frame with GIB Barrierline® central barrier

Specification number	Performance	Specifications
GBTLAB 60b	STC 64	Lining 1 x 10mm GIB Braceline®/GIB Noiseline® each side
	Rw 63	LB/NLB Load bearing
	FRR 60/60/60	Partition 280–310mm wide

WET AREA WALL LINING

If the 10mm GIB Braceline®/GIB Noiseline® wall lining is substituted with 10mm GIB Aqualine® on both sides, the FRR will be retained but a noise control reduction of 4 STC/Rw points can be expected.

If the 10mm GIB Braceline®/GIB Noiseline® wall lining is substituted with 13mm GIB Aqualine®, the FRR and noise control rating will be maintained.

JOINTING

Central Barrier: Unstopped.

Roof Laminate Layer: Unstopped

Wall lining: All fastener heads stopped and all sheet joints tape reinforced and stopped in accordance with the publication entitled GIB® Site Guide. Wall to ceiling junctions are to be reinforced with paper tape and square stopped or finished with GIB-Cove®.

Place two GIB® Wall Clips (one each side) no more than 600mm below the top of each GIB® H-Stud, no further apart than 3000mm vertically

10mm GIB Braceline®/
GIB Noiseline®

Pink® Batts®
R2.2 (90mm) glass
wool insulation

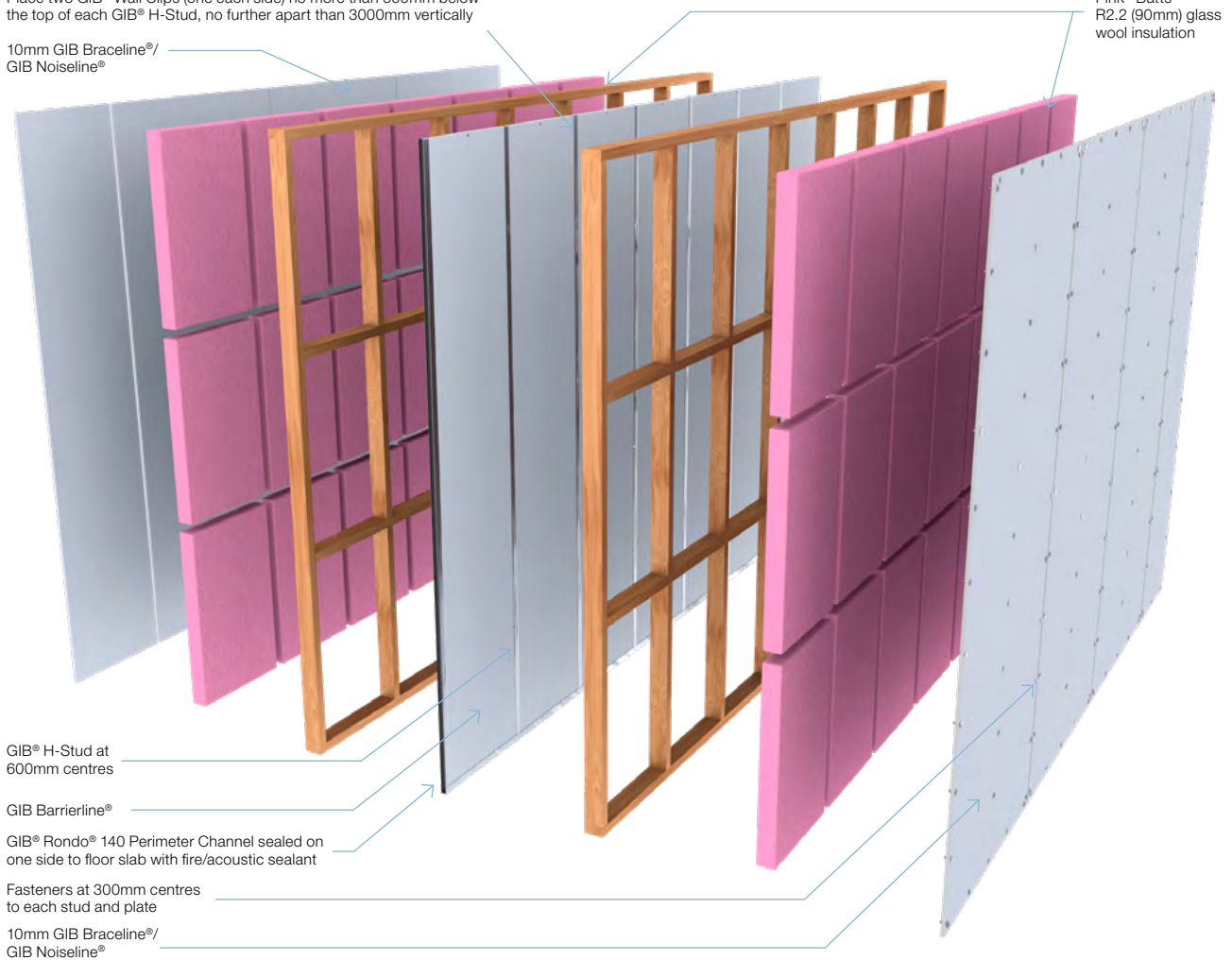

GIB® H-Stud at
600mm centres

GIB Barrierline®

GIB® Rondo® 140 Perimeter Channel sealed on
one side to floor slab with fire/acoustic sealant

Fasteners at 300mm centres
to each stud and plate

10mm GIB Braceline®/
GIB Noiseline®

Two way FRR – double timber frame with GIB Barrierline® central barrier

Specification number	Performance	Specifications
GBTLAB 60c	STC 67 Rw 65 FRR 60/60/60	Lining 1 x 13mm GIB Braceline®/GIB Noiseline® each side LB/NLB Load bearing Partition 286–316mm wide

TIMBER FRAMING

Stud size	Space between frames
90mm	80–110mm

Framing to comply with:

- NZBC B1 – Structure: AS1 Clause 3 – Timber (NZS 3604) or VM1 Clause 6 – Timber (NZS 3603).
- NZBC B2 – Durability: AS1 Clause 3.2 – Timber (NZS 3602).

Maximum height as determined by NZS 3604 stud and top plate tables for load-bearing walls.

CENTRAL BARRIER

- Allow a 25–40mm gap between each timber frame and the GIB Barrierline® central barrier.
- Fix GIB® Rondo® 140 Perimeter Channels to the concrete floor with steel fasteners at 600mm centres and no more than 50mm from channel ends using 3.5mm x 30mm or 4.0mm x 25mm concrete nails or 6mm x 40mm concrete anchors.
- A 5mm gap between GIB® Rondo® 140 Perimeter Channels will let any collected rain water escape.
- GIB® Rondo® 140 Perimeter Channel to be sealed to the floor slab on one side with exterior fire/acoustic sealant.
- Install 25mm GIB Barrierline® into GIB® H-Studs at 600mm centres.
- Cap GIB Barrierline® ends with GIB® Rondo® 140 Perimeter Channel.
- Offset GIB® H-Studs from wall studs to allow attachment of GIB® Wall Clips to both frames. Nog as required where no framing exists.
- Place two GIB® Wall Clips (one each side) no more than 600mm below the top of each GIB® H-Stud, no further apart than 3000mm vertically.
- Fix GIB® Rondo® 140 Perimeter Channel at wall ends to both timber frames with GIB® Wall Clips or GIB® Wall Straps placed no further apart than 3000mm vertically.
- Use no more than two GIB® Wall Clips or GIB® Wall Straps (one each side) for each 3000mm length of GIB® H-Stud or GIB® Rondo® 140 Perimeter Channel.
- In the roof space, fix a 13mm GIB Weatherline® or 13mm GIB Fyreline® Laminate to one side of the GIB Barrierline® with GIB® Laminator Screws or 40mm x 8g chipboard screws on a 400mm grid, and at no more than 100mm from sheet edges.
- Extend the laminate at least 200mm below ceiling level
- Once erected, protect the GIB Barrierline® and laminate from rain. The use of suitable sheeting can avoid delays in allowing the board to dry before wall linings are installed.
- If the specification calls for a 30 minute FRR a 10mm GIB Weatherline® laminate can be used.

SOUND CONTROL INFILL

Install Pink® Batts® R2.2 (90mm) glass wool insulation between the studs and nogs in both frames.

WALL LINING

A single layer of 13mm GIB Braceline®/GIB Noiseline® fixed vertically or horizontally.

Use full height sheets where possible.

Sheet joints are touch fitted and must occur over framing. Where sheet end butt joints are unavoidable they must be formed over framing.

If the wall lining forms part of the structural bracing system, the lining type and fixings must comply with the published bracing system. Check requirements for specific bracing element hold-down connections.

FASTENING THE LINING

Fasteners

32mm x 6g GIB® Grabber® High Thread Drywall Screws.

Fastener Centres

300mm centres to each stud, plate and sheet edge. Place screws no closer than 12mm from paperbound edges and 18mm from any sheet end or cut edges.

BUILDING SERVICE PENETRATIONS

GIB® Intertency Barrier Systems allow installation of plumbing and electrical services in the cavities either side of the central barrier. Back-to-back services and penetrations are permitted within the limitations given below. A minimum of 10 mm clearance must be provided between plumbing or electrical services and the central barrier.

Plumbing services up to 65 mm in diameter and electrical services up to 90 x 50 mm do not need specialist fire-stopping where they penetrate the wall linings. The maximum number of unprotected service penetration is limited to two per nominally 600 mm wide framing cavity. Plumbing service penetrations through wall linings must have neatly cut holes with 6 mm maximum clearance around the plumbing service. Fill the gap with a general purpose flexible sealant.

Suitable proprietary fire-stopping is required for wall lining penetrations larger than 90 x 50 mm or 65 mm in diameter, and for penetrations through the GIB Barrierline® core in the roof space.

WET AREA WALL LINING

If the 13mm GIB Braceline®/GIB Noiseline® wall lining is substituted with 13mm GIB Aqualine® on both sides, the FRR will be retained but a noise control reduction of 3 STC/Rw points can be expected.

Two way FRR – double timber frame with GIB Barrierline® central barrier

Specification number	Performance	Specifications
GBTLAB 60c	STC 67	Lining 1 x 13mm GIB Braceline®/GIB Noiseline® each side
	Rw 65	LB/NLB Load bearing
	FRR 60/60/60	Partition 286–316mm wide

JOINTING

Central Barrier: Unstopped.

Roof Laminated Layer: Unstopped

Wall lining: All fastener heads stopped and all sheet joints tape reinforced and stopped in accordance with the publication entitled GIB® Site Guide. Wall to ceiling junctions are to be reinforced with paper tape and square stopped or finished with GIB-Cove®.

Place two GIB® Wall Clips (one each side) no more than 600mm below the top of each GIB® H-Stud, no further apart than 3000mm vertically

13mm GIB Braceline®/
GIB Noiseline®

Pink® Batts®
R2.2 (90mm) glass
wool insulation

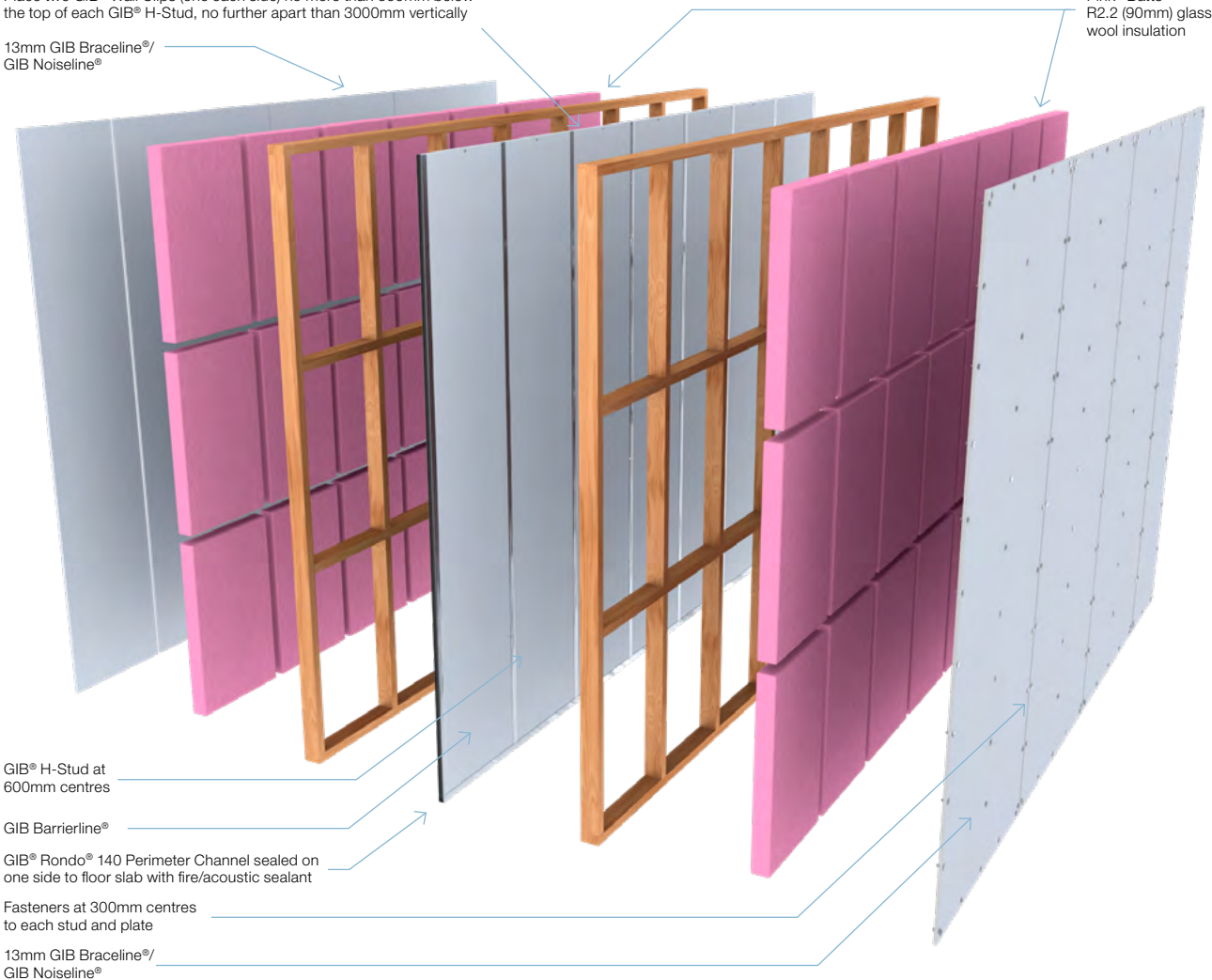

GIB® H-Stud at
600mm centres

GIB Barrierline®

GIB® Rondo® 140 Perimeter Channel sealed on
one side to floor slab with fire/acoustic sealant

Fasteners at 300mm centres
to each stud and plate

13mm GIB Braceline®/
GIB Noiseline®

Two way FRR – double timber frame with GIB Barrierline® central barrier

Specification number	Performance	Specifications
GBTLAB 60d	STC 61 Rw 60 FRR 60/60/60	Lining 1 x 13mm GIB® Standard each side LB/NLB Load bearing Partition 286–316mm wide

TIMBER FRAMING

Stud size	Space between frames
90mm	80–110mm

Framing to comply with:

- NZBC B1 – Structure: AS1 Clause 3 – Timber (NZS 3604) or VM1 Clause 6 – Timber (NZS 3603).
- NZBC B2 – Durability: AS1 Clause 3.2 – Timber (NZS 3602).

Maximum height as determined by NZS 3604 stud and top plate tables for load-bearing walls.

CENTRAL BARRIER

- Allow a 25–40mm gap between each timber frame and the GIB Barrierline® central barrier.
- Fix GIB® Rondo® 140 Perimeter Channels to the concrete floor with steel fasteners at 600mm centres and no more than 50mm from channel ends using 3.5mm x 30mm or 4.0mm x 25mm concrete nails or 6mm x 40mm concrete anchors.
- A 5mm gap between GIB® Rondo® 140 Perimeter Channels will let any collected rain water escape.
- GIB® Rondo® 140 Perimeter Channel to be sealed to the floor slab on one side with exterior fire/acoustic sealant.
- Install 25mm GIB Barrierline® into GIB® H-Studs at 600mm centres.
- Cap GIB Barrierline® ends with GIB® Rondo® 140 Perimeter Channel.
- Offset GIB® H-Studs from wall studs to allow attachment of GIB® Wall Clips to both frames. Nog as required where no framing exists.
- Place two GIB® Wall Clips (one each side) no more than 600mm below the top of each GIB® H-Stud, no further apart than 3000mm vertically.
- Fix GIB® Rondo® 140 Perimeter Channel at wall ends to both timber frames with GIB® Wall Clips or GIB® Wall Straps placed no further apart than 3000mm vertically.
- Use no more than two GIB® Wall Clips or GIB® Wall Straps (one each side) for each 3000mm length of GIB® H-Stud or GIB® Rondo® 140 Perimeter Channel.
- In the roof space, fix a 13mm GIB Weatherline® or 13mm GIB Fyreline® Laminate to one side of the GIB Barrierline® with GIB® Laminator Screws or 40mm x 8g chipboard screws on a 400mm grid, and at no more than 100mm from sheet edges.
- Extend the laminate at least 200mm below ceiling level
- Once erected, protect the GIB Barrierline® and laminate from rain. The use of suitable sheeting can avoid delays in allowing the board to dry before wall linings are installed.
- If the specification calls for a 30 minute FRR a 10mm GIB Weatherline® laminate can be used.

SOUND CONTROL INFILL

Install Pink® Batts® R2.2 (90mm) glass wool insulation between the studs and nogs in both frames.

WALL LINING

A single layer of 13mm GIB® Standard fixed vertically or horizontally.

Use full height sheets where possible.

Sheet joints are touch fitted and must occur over framing. Where sheet end butt joints are unavoidable they must be formed over framing.

If the wall lining forms part of the structural bracing system, the lining type and fixings must comply with the published bracing system. Check requirements for specific bracing element hold-down connections.

FASTENING THE LINING

Fasteners

32mm x 6g GIB® Grabber® High Thread Drywall Screws.

Fastener centres

300mm centres to each stud, plate and sheet edge. Place screws no closer than 12mm from paperbound edges and 18mm from any sheet end or cut edges.

BUILDING SERVICE PENETRATIONS

GIB® Intertenancy Barrier Systems allow installation of plumbing and electrical services in the cavities either side of the central barrier. Back-to-back services and penetrations are permitted within the limitations given below. A minimum of 10 mm clearance must be provided between plumbing or electrical services and the central barrier.

Plumbing services up to 65 mm in diameter and electrical services up to 90 x 50 mm do not need specialist fire-stopping where they penetrate the wall linings. The maximum number of unprotected service penetration is limited to two per nominally 600 mm wide framing cavity. Plumbing service penetrations through wall linings must have neatly cut holes with 6 mm maximum clearance around the plumbing service. Fill the gap with a general purpose flexible sealant.

Suitable proprietary fire-stopping is required for wall lining penetrations larger than 90 x 50 mm or 65 mm in diameter, and for penetrations through the GIB Barrierline® core in the roof space.

Two way FRR – double timber frame with GIB Barrierline® central barrier

Specification number	Performance	Specifications
GBTLAB 60d	STC 61	Lining 1 x 13mm GIB® Standard each side
	Rw 60	LB/NLB Load bearing
	FRR 60/60/60	Partition 286–316mm wide

WET AREA WALL LINING

If the 13mm GIB® Standard wall lining is substituted with 13mm GIB Aqualine®, the FRR and noise control rating will be retained.

JOINTING

Central Barrier: Unstopped.

Roof Laminate Layer: Unstopped

Wall lining: All fastener heads stopped and all sheet joints tape reinforced and stopped in accordance with the publication entitled GIB® Site Guide. Wall to ceiling junctions are to be reinforced with paper tape and square stopped or finished with GIB-Cove®.

Place two GIB® Wall Clips (one each side) no more than 600mm below the top of each GIB® H-Stud, no further apart than 3000mm vertically

13mm GIB® Standard

Pink® Batts®
R2.2 (90mm) glass
wool insulation

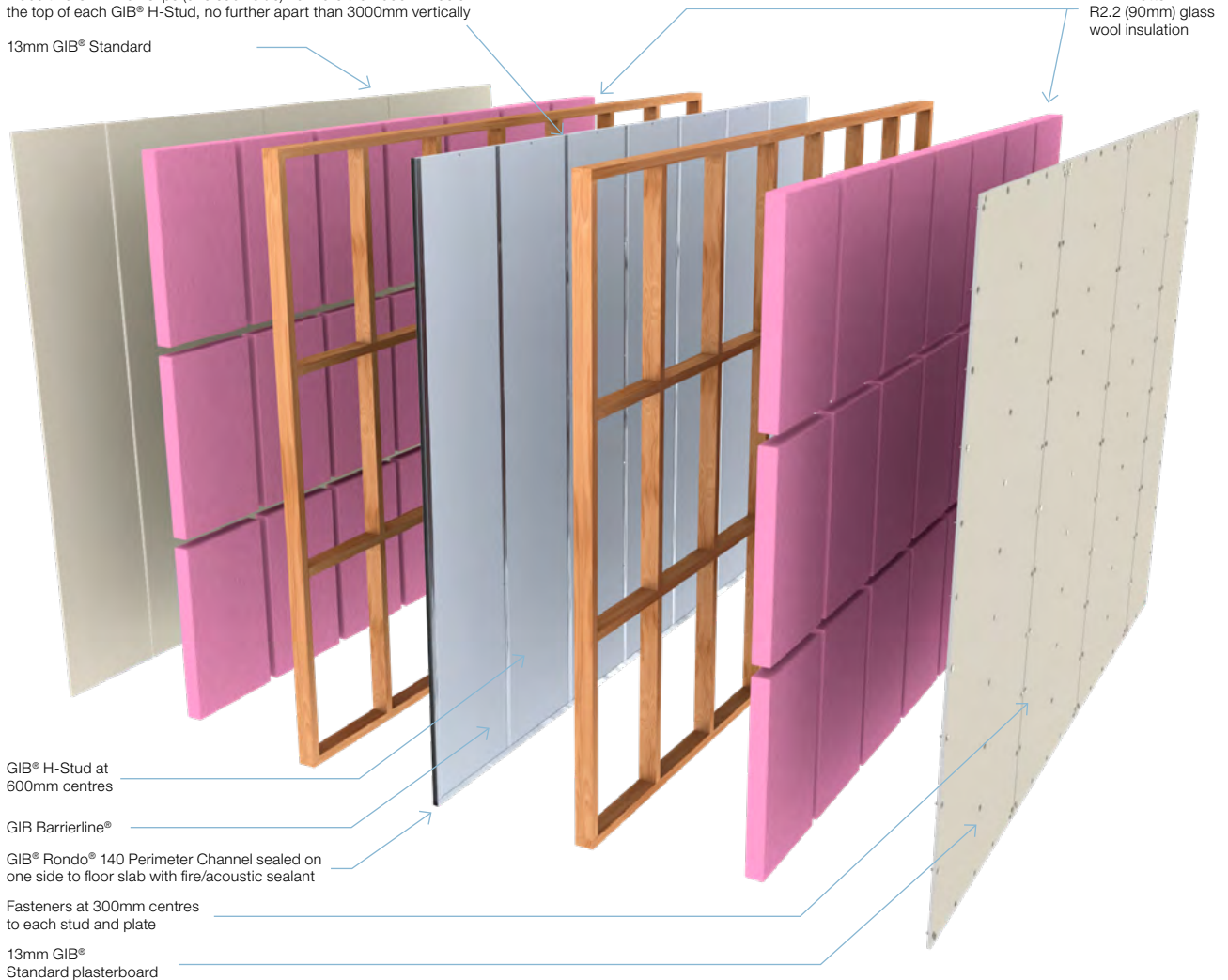

GIB® H-Stud at
600mm centres

GIB Barrierline®

GIB® Rondo® 140 Perimeter Channel sealed on
one side to floor slab with fire/acoustic sealant

Fasteners at 300mm centres
to each stud and plate

13mm GIB®
Standard plasterboard

Two way FRR — double steel frame with GIB Barrierline® central barrier

Specification	Performance	Specifications
GBSLAB 60a	STC 61 Rw 60 FRR 60/60/60	Lining 1 x 13mm GIB® Standard each side LB/NLB Load bearing Partition 290-320mm wide (with nominal 90mm stud)

STEEL FRAMING

Framing to comply with:

- NZBC B1 – Structure: Acceptable Solution B1/AS1 Clause 9.1 – NASH Standard Part 2: May 2019 Light Steel Framed Buildings, or Verification Method B1/VM1
- NZBC B2 – Durability: Acceptable Solution B2/AS1.

C section studs shall have a minimum thickness of 0.75mm and minimum nominal depth of 90mm with 35mm wide flanges.

CENTRAL BARRIER

- Allow a 25-40mm gap between each steel frame and the GIB Barrierline® central barrier.
- Fix GIB® Rondo® 140 Perimeter Channels to the concrete floor with steel fasteners at 600mm centres and no more than 50mm from channel ends using 3.5mm x 30mm or 4.0mm x 25mm concrete nails or 6mm x 40mm concrete anchors.
- A 5mm gap between GIB® Rondo® 140 Perimeter Channels will let any collected rain water escape.
- GIB® Rondo® 140 Perimeter Channel to be sealed to the floor slab on one side with exterior fire/acoustic sealant.
- Install 25mm GIB Barrierline® into GIB® H-Studs at 600mm centres.
- Cap GIB Barrierline® ends with GIB® Rondo® 140 Perimeter Channel.
- Offset GIB® H-Studs at least 100mm from steel studs to allow attachment of GIB® Wall Clips to both frames. Nog as required where no framing exists.
- Place two GIB® Wall Clips (one each side) no more than 600mm below the top of each GIB® H-Stud, no further apart than 3000mm vertically.
- Fix GIB® Rondo® 140 Perimeter Channel at wall ends to both steel frames with GIB® Wall Clips or GIB® Wall Straps placed no further apart than 3000mm vertically.
- Use no more than two GIB® Wall Clips or GIB® Wall Straps (one each side) for each 3000mm length of GIB® H-Stud or GIB® Rondo® 140 Perimeter Channel.
- In the roof space, fix a 13mm GIB Weatherline® or 13mm GIB Fyreline® Laminate to one side of the GIB Barrierline® with GIB® Laminator Screws or 40mm x 8g chipboard screws on a 400mm grid, and at no more than 100mm from sheet edges.
- Extend the laminate at least 200mm below ceiling level
- Once erected, protect the GIB Barrierline® and laminate from rain. The use of suitable sheeting can avoid delays in allowing the board to dry before wall linings are installed.
- If the specification calls for a 30 minute FRR a 10mm GIB Weatherline® laminate can be used.

SOUND CONTROL INFILL

Pink® Batts® wall R2.2 (90mm) glass wool insulation installed between the studs in both frames.

WALL LINING

A single layer of 13mm GIB® Standard each side of the frame.

Vertical or horizontal fixing permitted. For vertical fixings, full height sheets shall be used where possible. When sheet end butt joints are unavoidable, they shall be formed over nogs and staggered. When fixing horizontally all longitudinal sheet joints must be formed over nogs.

Sheets fitted hard to floor. Sheet joints are touch fitted and must occur over framing.

FASTENING THE LINING

Fasteners

25mm x 6g GIB® Grabber® Self Tapping Drywall Screws.

Fastener centres

300mm centres up each stud. Place fasteners 12mm from longitudinal sheet edges and 50mm from sheet ends. Place fasteners at 200mm centres along sheet end butt joints.

BUILDING SERVICE PENETRATIONS

GIB® Intertenancy Barrier Systems allow installation of plumbing and electrical services in the cavities either side of the central barrier. Back-to-back services and penetrations are permitted within the limitations given below. A minimum of 10 mm clearance must be provided between plumbing or electrical services and the central barrier.

Plumbing services up to 65 mm in diameter and electrical services up to 90 x 50 mm do not need specialist fire-stopping where they penetrate the wall linings. The maximum number of unprotected service penetration is limited to two per nominally 600 mm wide framing cavity. Plumbing service penetrations through wall linings must have neatly cut holes with 6 mm maximum clearance around the plumbing service. Fill the gap with a general purpose flexible sealant.

Suitable proprietary fire-stopping is required for wall lining penetrations larger than 90 x 50 mm or 65 mm in diameter, and for penetrations through the GIB Barrierline® core in the roof space.

Two way FRR — double steel frame with GIB Barrierline® central barrier

Specification	Performance	Specifications
GBSLAB 60a	STC 61 Rw 60 FRR 60/60/60	Lining 1 x 13mm GIB® Standard each side LB/NLB Load bearing Partition 290-320mm wide (with nominal 90mm stud)

WET AREA WALL LINING

If the 13mm GIB® Standard wall lining is substituted with 13mm GIB Aqualine®, the FRR and noise control rating will be retained.

JOINTING

Central barrier: Unstopped.

Wall laminate: All fastener heads stopped and all sheet joints tape reinforced and stopped in accordance with the publication entitled GIB® Site Guide. Wall to ceiling junctions are to be reinforced with paper tape and square stopped or finished with GIB-Cove®.

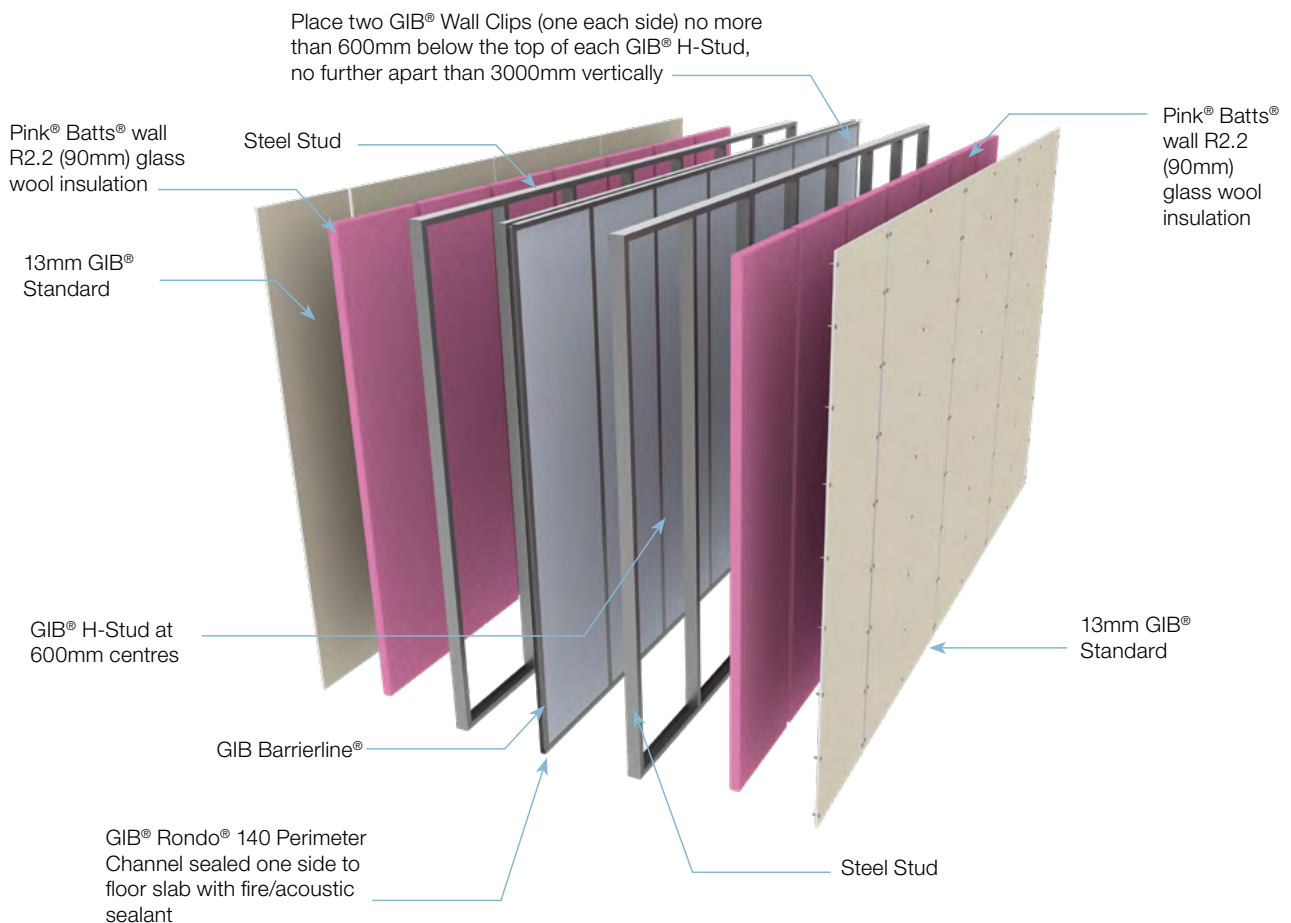

Two way FRR — double steel frame with GIB Barrierline® central barrier

Specification	Performance	Specifications
GBSLAB 60b	STC 67 Rw 65 FRR 60/60/60	Lining 1 x 13mm GIB Braceline®/GIB Noiseline® each side LB/NLB Load bearing Partition 290-320mm wide (with nominal 90mm stud)

STEEL FRAMING

Framing to comply with:

- NZBC B1 – Structure: Acceptable Solution B1/AS1 Clause 9.1 NASH Standard Part 2: May 2019 Light Steel Framed Buildings, or Verification Method B1/VM1
- NZBC B2 – Durability: Acceptable Solution B2/AS1.

C section studs shall have a minimum thickness of 0.75mm and minimum nominal depth of 90mm with 35mm wide flanges.

CENTRAL BARRIER

- Allow a 25-40mm gap between each steel frame and the GIB Barrierline® central barrier.
- Fix GIB® Rondo® 140 Perimeter Channels to the concrete floor with steel fasteners at 600mm centres and no more than 50mm from channel ends using 3.5mm x 30mm or 4.0mm x 25mm concrete nails or 6mm x 40mm concrete anchors.
- A 5mm gap between GIB® Rondo® 140 Perimeter Channels will let any collected rain water escape.
- GIB® Rondo® 140 Perimeter Channel to be sealed to the floor slab on one side with exterior fire/acoustic sealant.
- Install 25mm GIB Barrierline® into GIB® H-Studs at 600mm centres.
- Cap GIB Barrierline® ends with GIB® Rondo® 140 Perimeter Channel.
- Offset GIB® H-Studs from steel studs to allow attachment of GIB® Wall Clips to both frames. Nog as required where no framing exists.
- Place two GIB® Wall Clips (one each side) no more than 600mm below the top of each GIB® H-Stud, no further apart than 3000mm vertically.
- Fix GIB® Rondo® 140 Perimeter Channel at wall ends to both steel frames with GIB® Wall Clips or GIB® Wall Straps placed no further apart than 3000mm vertically.
- Use no more than two GIB® Wall Clips or GIB® Wall Straps (one each side) for each 3000mm length of GIB® H-Stud or GIB® Rondo® 140 Perimeter Channel.
- In the roof space, fix a 13mm GIB Weatherline® or 13mm GIB Fyreline® Laminate to one side of the GIB Barrierline® with GIB® Laminator Screws or 40mm x 8g chipboard screws on a 400mm grid, and at no more than 100mm from sheet edges.
- Extend the laminate at least 200mm below ceiling level
- Once erected, protect the GIB Barrierline® and laminate from rain. The use of suitable sheeting can avoid delays in allowing the board to dry before wall linings are installed.
- If the specification calls for a 30 minute FRR a 10mm GIB Weatherline® laminate can be used.

SOUND CONTROL INFILL

Pink® Batts® wall R2.2 (90mm) glass wool insulation installed between the studs in both frames.

WALL LINING

A single layer of 13mm GIB Braceline®/GIB Noiseline® each side of the frame.

Vertical or horizontal fixing permitted. For vertical fixings, full height sheets shall be used where possible. When sheet end butt joints are unavoidable, they shall be formed over nogs and staggered. When fixing horizontally all longitudinal sheet joints must be formed over nogs.

Sheets fitted hard to floor. Sheet joints are touch fitted and must occur over framing.

FASTENING THE LINING

Fasteners

25mm x 6g GIB® Grabber® Self Tapping Drywall Screws.

Fastener centres

300mm centres up each stud. Place fasteners 12mm from longitudinal sheet edges and 50mm from sheet ends. Place fasteners at 200mm centres along sheet end butt joints.

BUILDING SERVICE PENETRATIONS

GIB® Intertenancy Barrier Systems allow installation of plumbing and electrical services in the cavities either side of the central barrier. Back-to-back services and penetrations are permitted within the limitations given below. A minimum of 10 mm clearance must be provided between plumbing or electrical services and the central barrier.

Plumbing services up to 65 mm in diameter and electrical services up to 90 x 50 mm do not need specialist fire-stopping where they penetrate the wall linings. The maximum number of unprotected service penetration is limited to two per nominally 600 mm wide framing cavity. Plumbing service penetrations through wall linings must have neatly cut holes with 6 mm maximum clearance around the plumbing service. Fill the gap with a general purpose flexible sealant.

Suitable proprietary fire-stopping is required for wall lining penetrations larger than 90 x 50 mm or 65 mm in diameter, and for penetrations through the GIB Barrierline® core in the roof space.

Two way FRR — double steel frame with GIB Barrierline® central barrier

Specification	Performance	Specifications
GBSLAB 60b	STC 67 Rw 65 FRR 60/60/60	Lining 1 x 13mm GIB Braceline®/GIB Noiseline® each side LB/NLB Load bearing Partition 290-320mm wide (with nominal 90mm stud)

WET AREA WALL LINING

If the 13mm GIB Braceline®/GIB Noiseline® wall lining is substituted with 13mm GIB Aqualine®, the FRR will be retained but a noise control reduction of up to 3 STC/Rw points can be expected.

JOINTING

Central barrier: Unstopped.

Wall laminate: All fastener heads stopped and all sheet joints tape reinforced and stopped in accordance with the publication entitled GIB® Site Guide. Wall to ceiling junctions are to be reinforced with paper tape and square stopped or finished with GIB-Cove®.

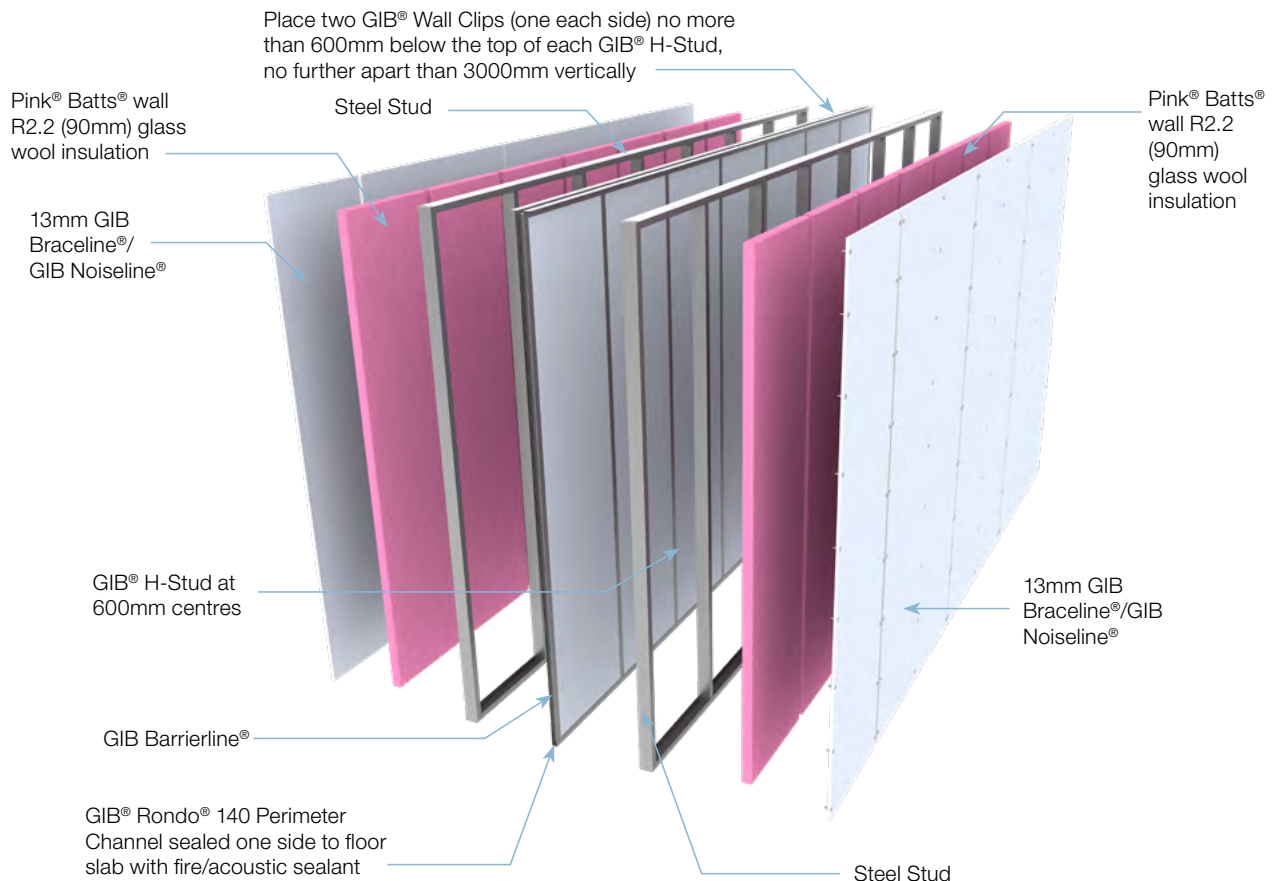

BASE DETAIL AT SLAB (END ELEVATION)

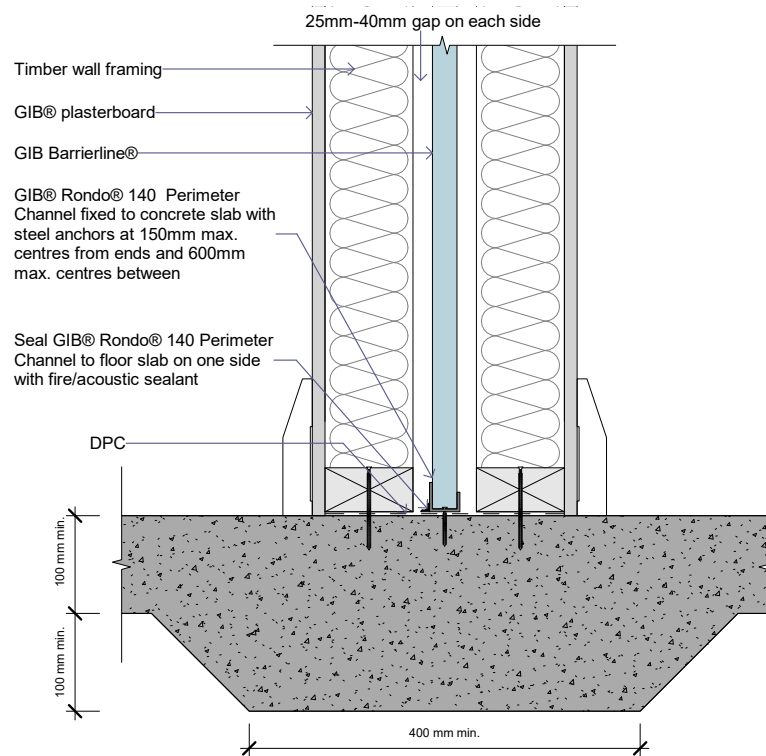

GNS101

STEPPED FLOOR (END ELEVATION)

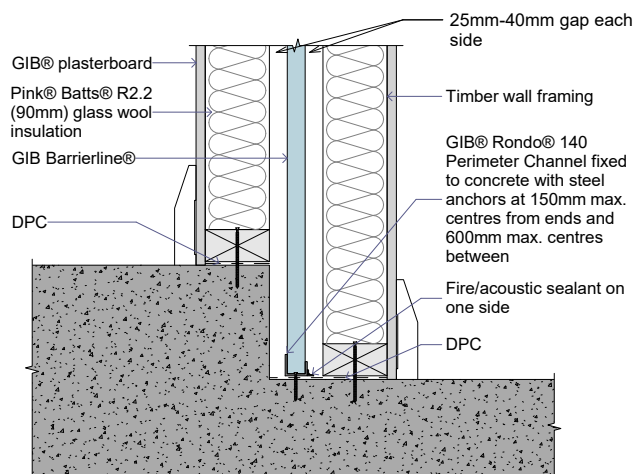

GNS121

DETAIL AT FOUNDATION WALL

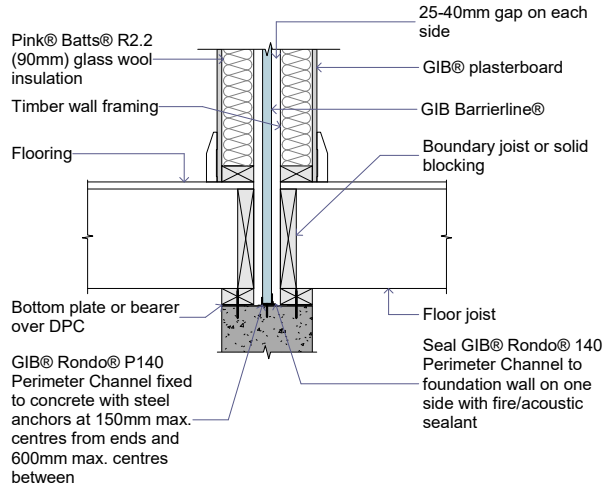

GNS120

DETAIL AT UPPER STOREY FRAMED FLOOR (END ELEVATION)

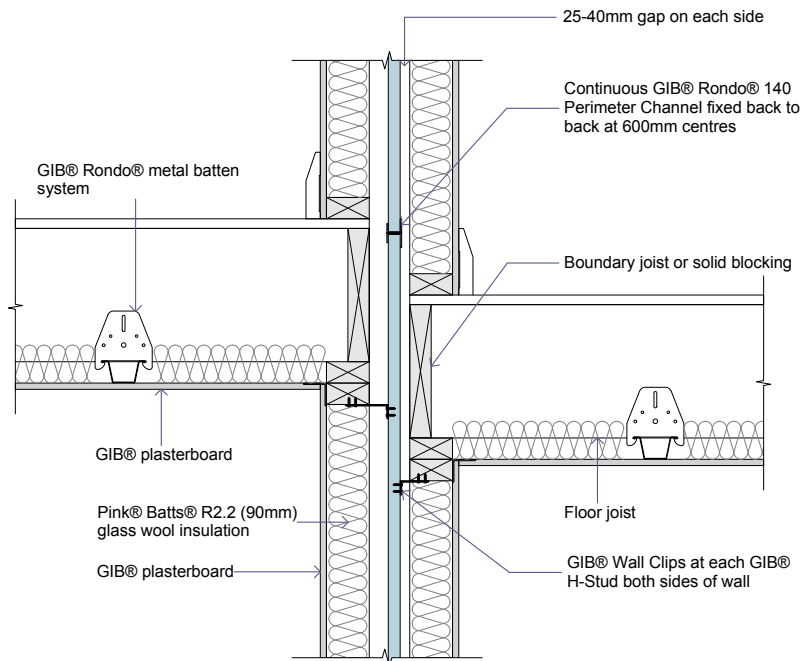

GNS100

FIXING DETAIL FOR GIB WEATHERLINE® OR GIB FYRELINE® LAMINATE

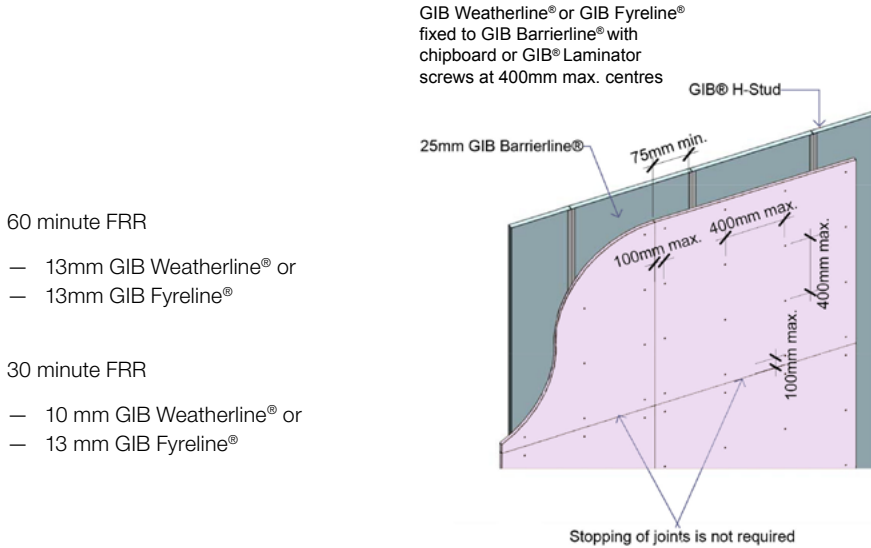

60 minute FRR

- 13mm GIB Weatherline® or
- 13mm GIB Fyrelime®

30 minute FRR

- 10 mm GIB Weatherline® or
- 13 mm GIB Fyrelime®

GNS111

EAVES DETAIL (SIDE ELEVATION)

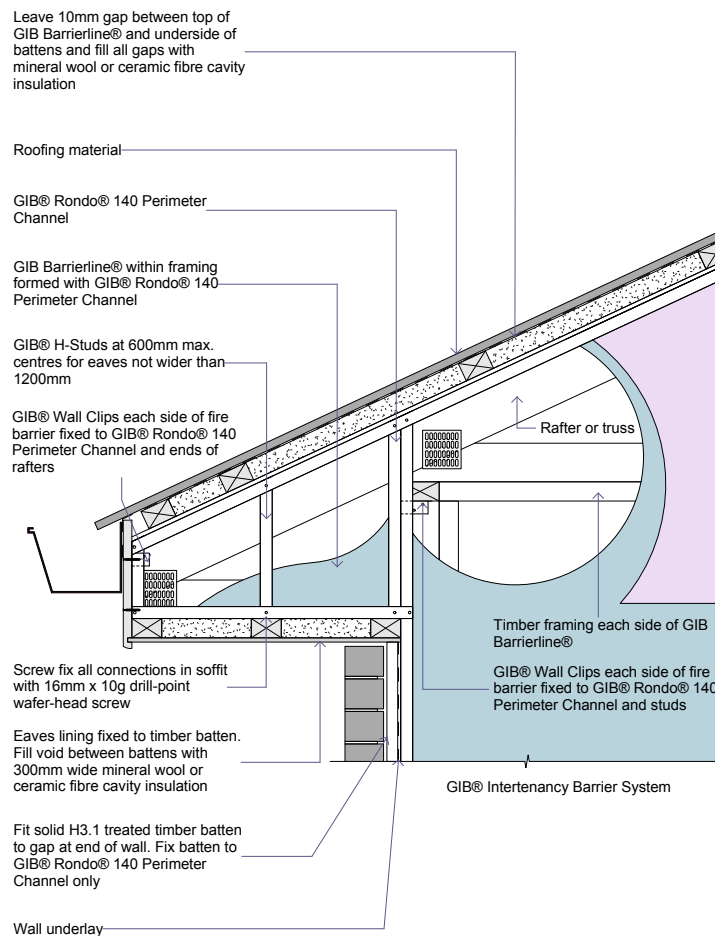

GNS112

ROOF VOID DETAIL WITH HORIZONTAL SHEETING (SIDE ELEVATION)

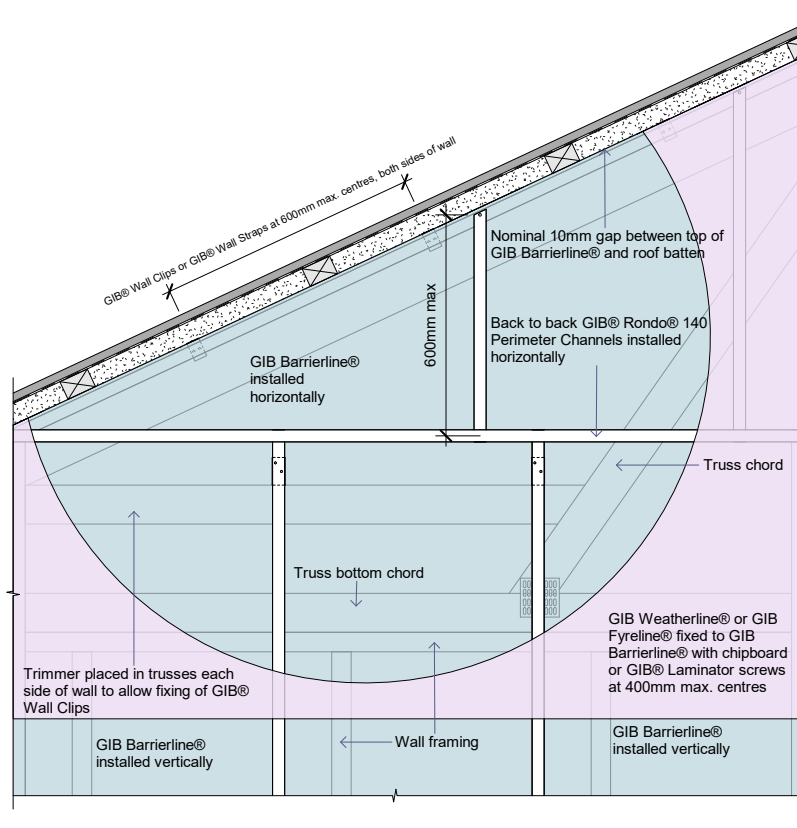

GNS113

DETAIL AT CEILING AND ROOF (END ELEVATION)

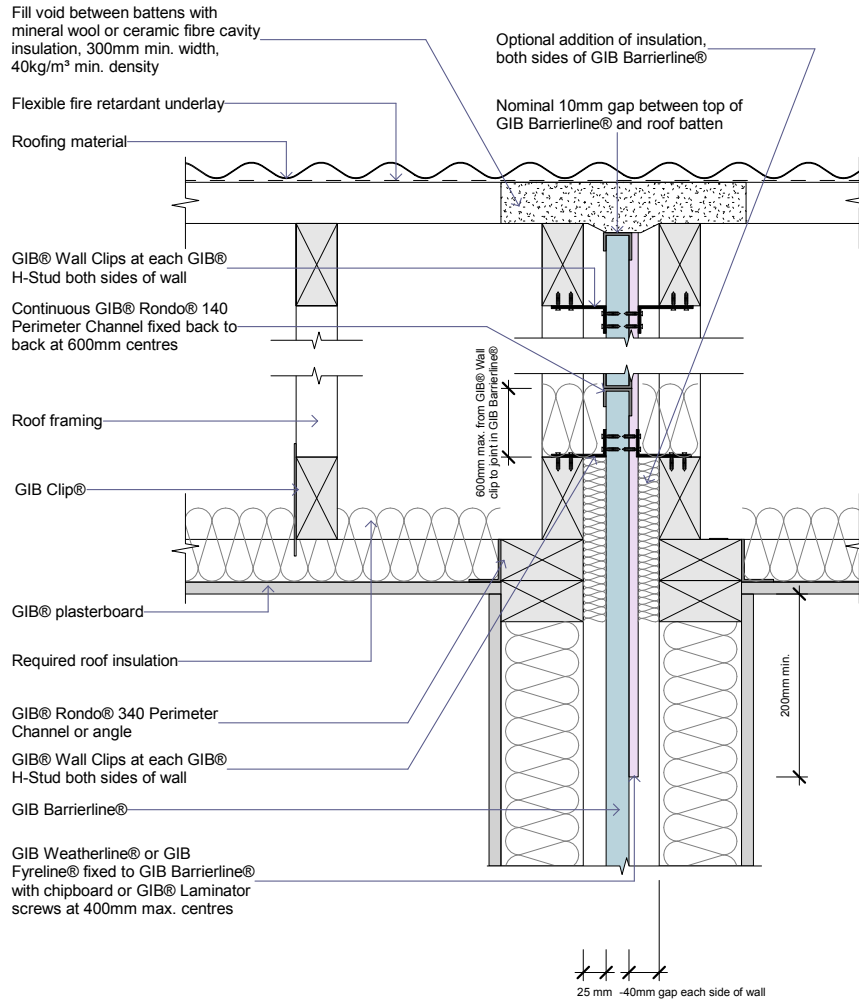

GNS105

DETAIL AT ROOF/CEILING (END ELEVATION)

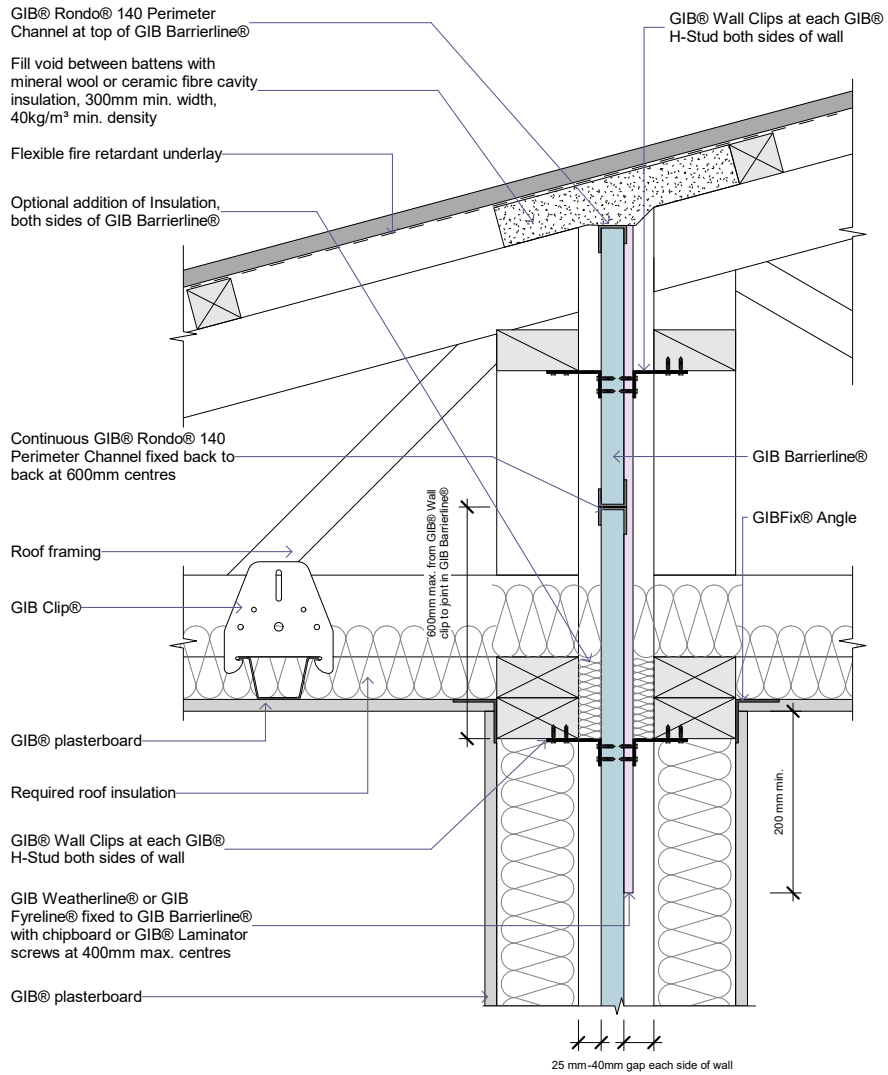

GNS108

DETAIL AT ROOF/CEILING AND PARAPET (END ELEVATION)

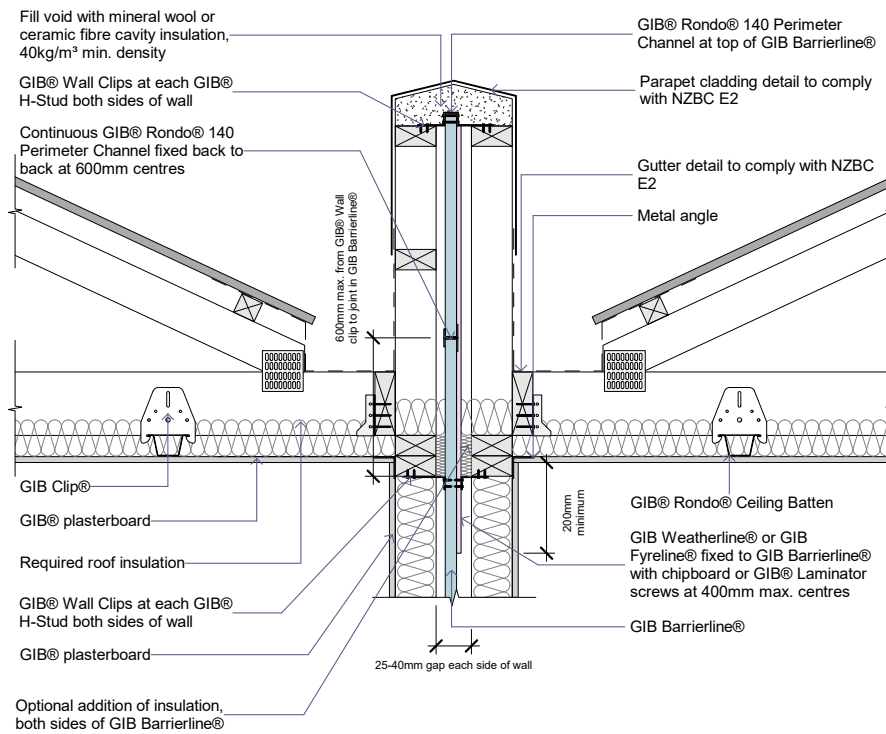

GNS109

DETAIL AT ROOF APEX

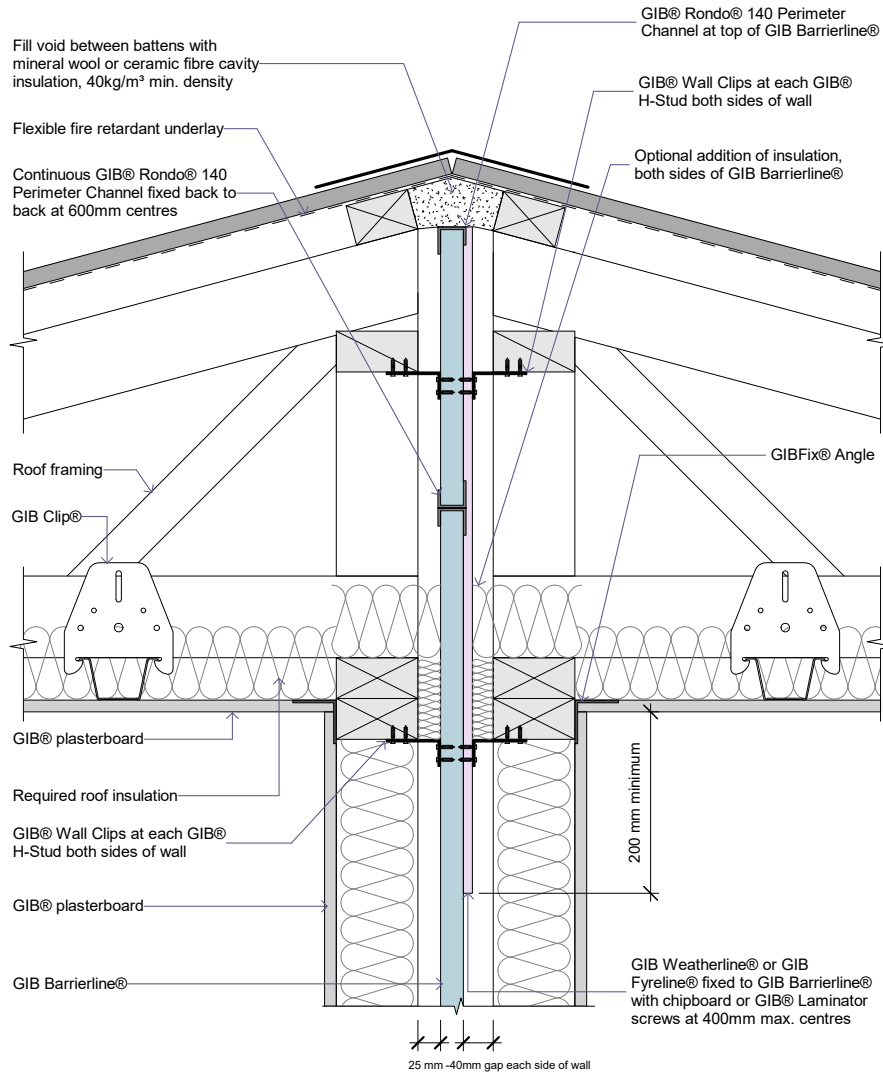

GNS122

STEPPED ROOF OPTION A (GIB WEATHERLINE®)

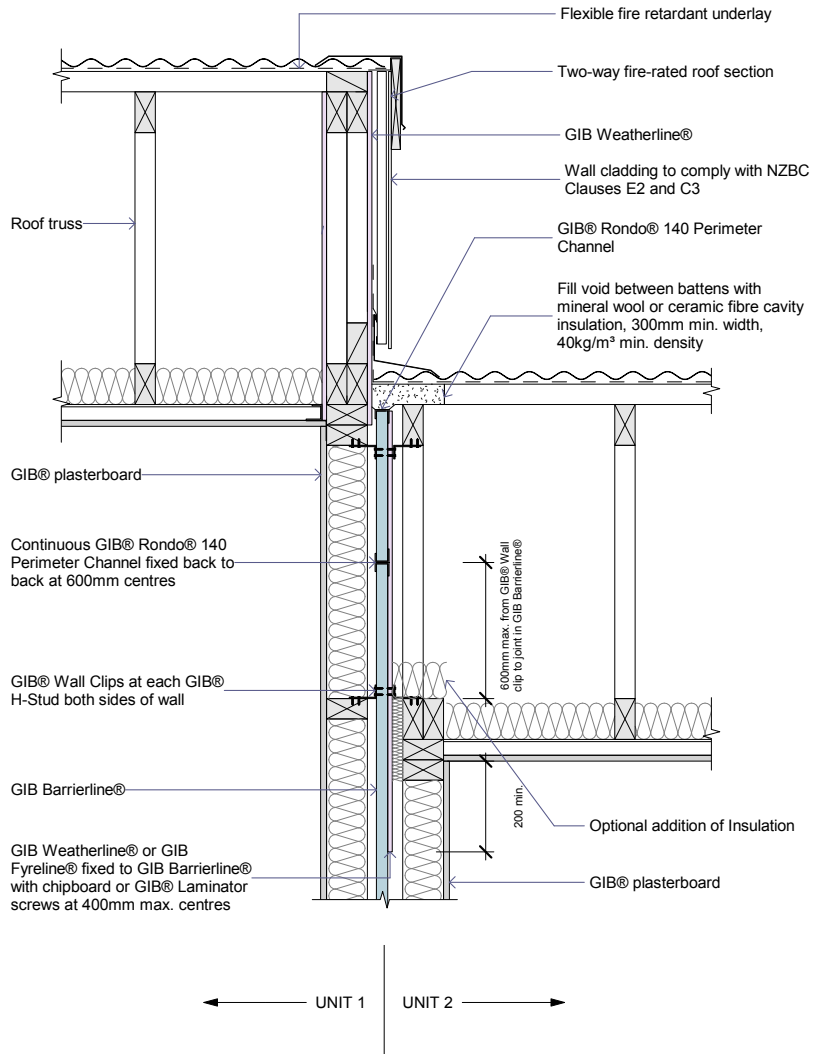

GNS342

STEPPED ROOF OPTION B (GIB WEATHERLINE®)

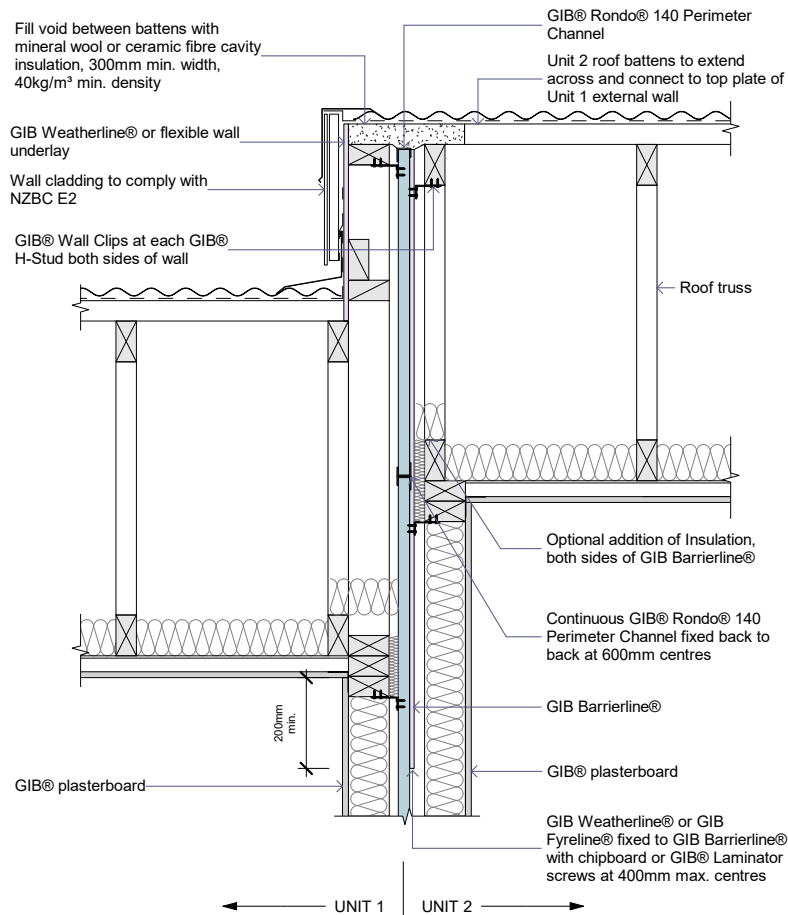

Note: The maximum allowable difference in the two roof heights will depend on the roof structure and external wall of Unit 1. This will need to be determined by Specific Engineering Design (SED).

EXTERNAL BRICK VENEER WALL (WITH GIB WEATHERLINE®)

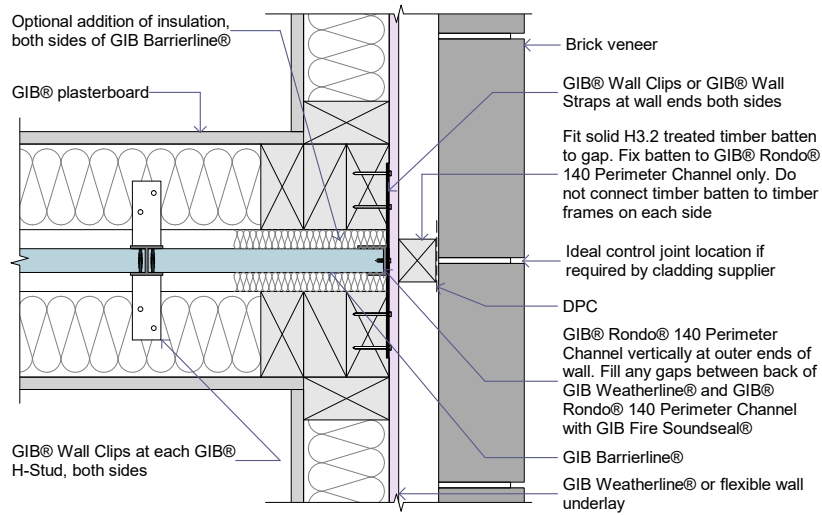

GNS128

RETURN DETAIL EXTERNAL BRICK VENEER (WITH GIB WEATHERLINE®)

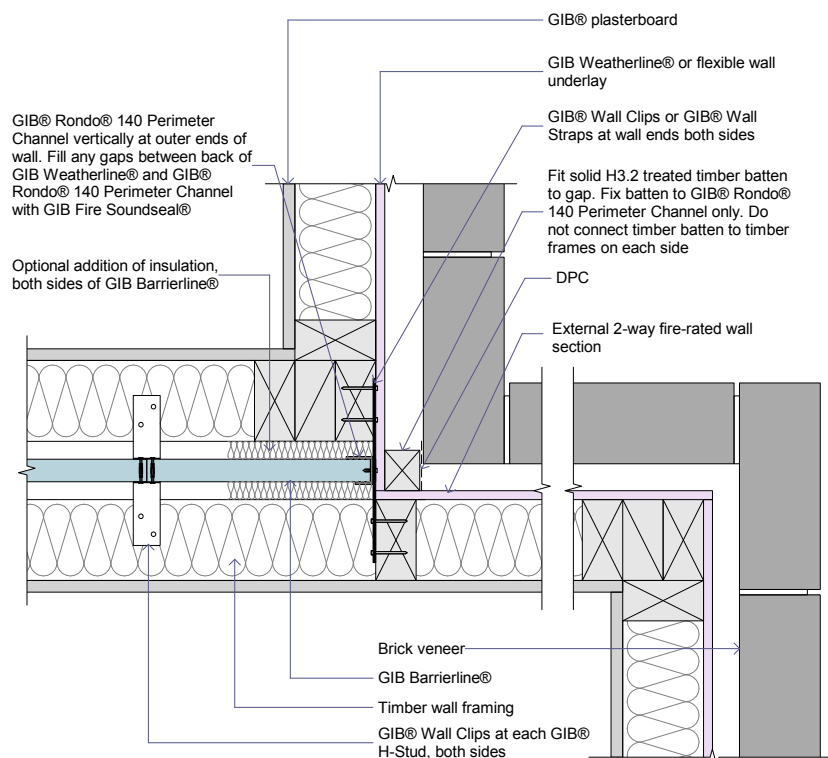

GNS126

DETAIL AT EXTERNAL BRICK VENEER WALL (WITH GIB WEATHERLINE®)

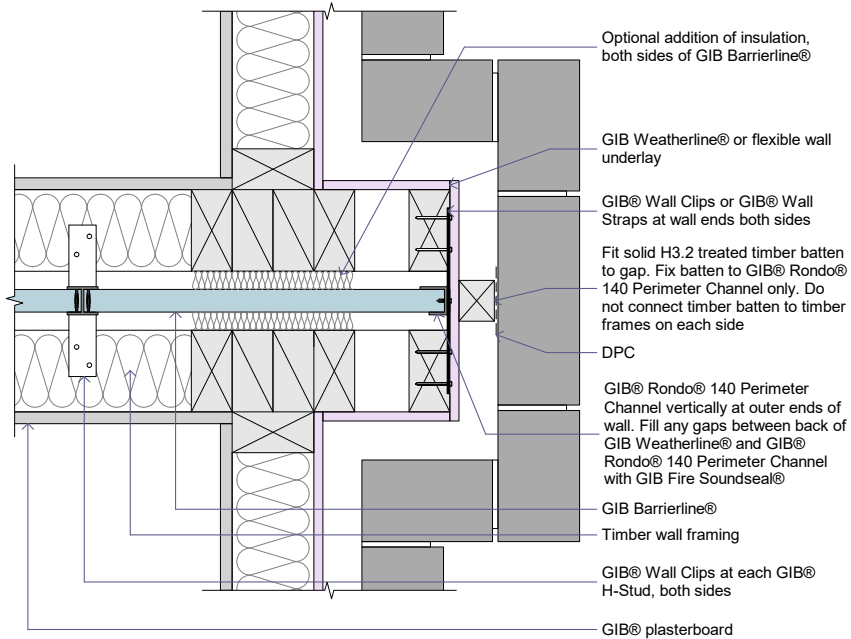

Note: Maximum allowable length of intertenancy wall projection will depend on building height and supporting structure. This will need to be determined by Specific Engineering Design (SED).

GNS125

EXTERNAL TIMBER FRAME (WITH GIB WEATHERLINE®)

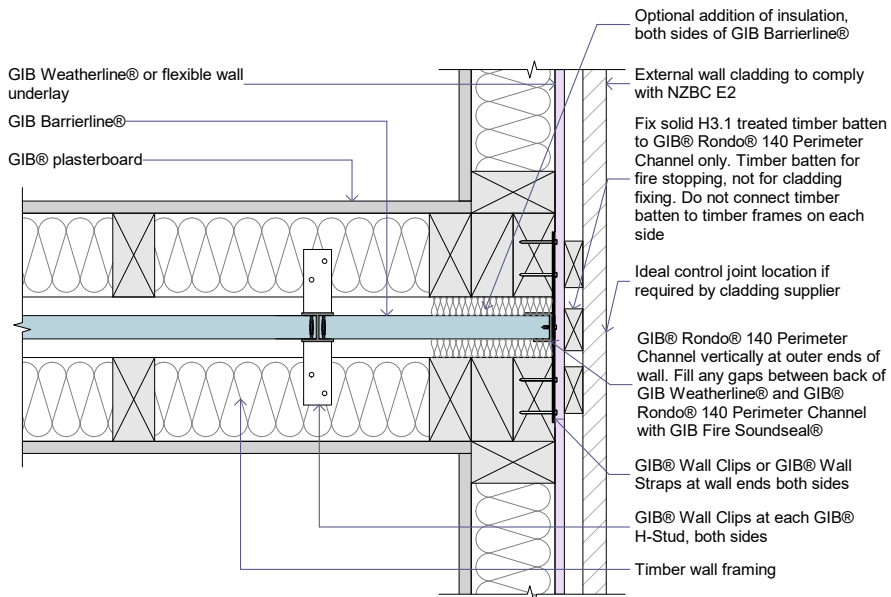

GNS123

DETAIL AT RETURN IN EXTERNAL LIGHTWEIGHT CLADDING (WITH GIB WEATHERLINE®)

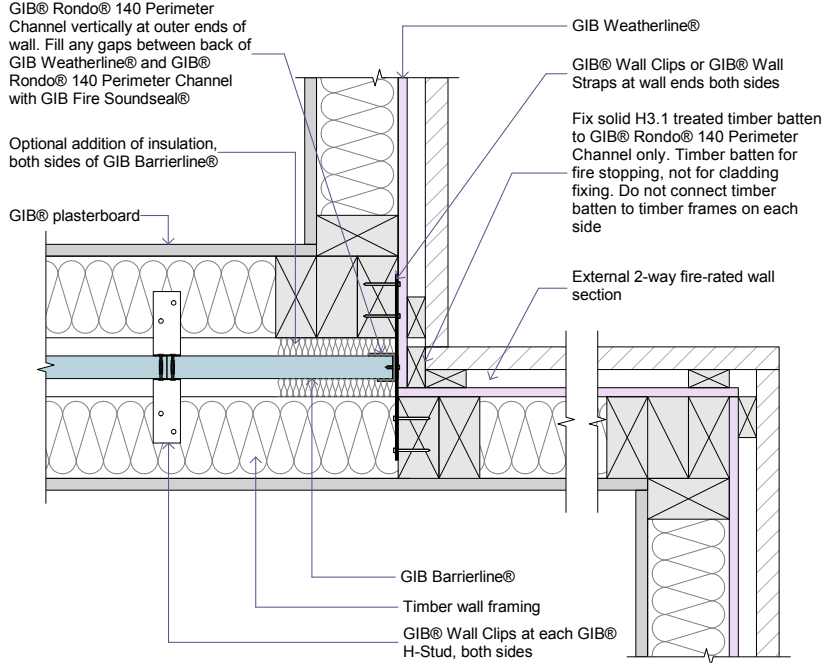

GNS127

DETAIL AT RETURN IN EXTERNAL TIMBER FRAME WALL (WITH GIB WEATHERLINE®)

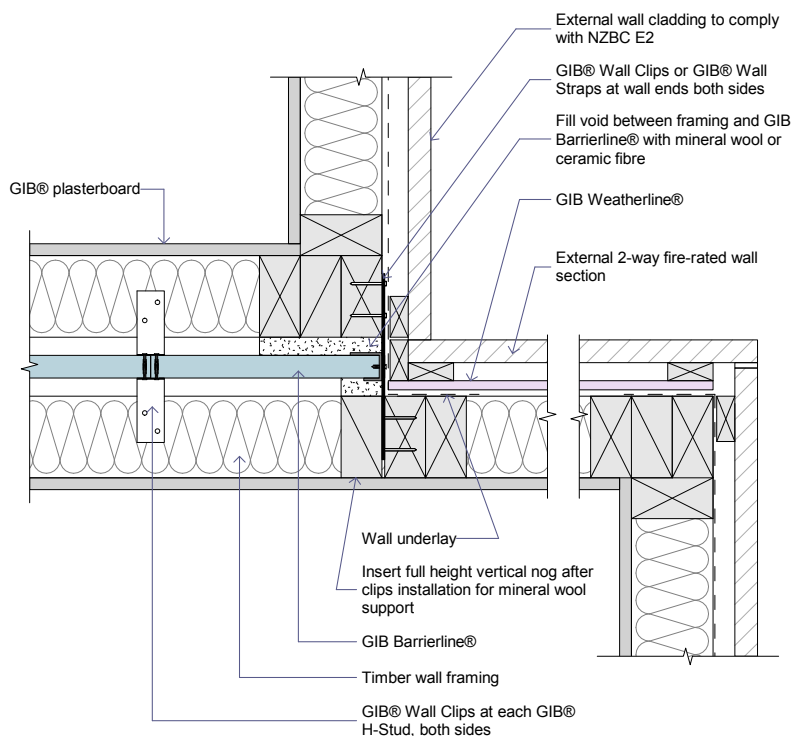

GNS330

INTERTENANCY WALL PROJECTION AT EXTERNAL TIMBER FRAME WALL (WITH GIB WEATHERLINE®)

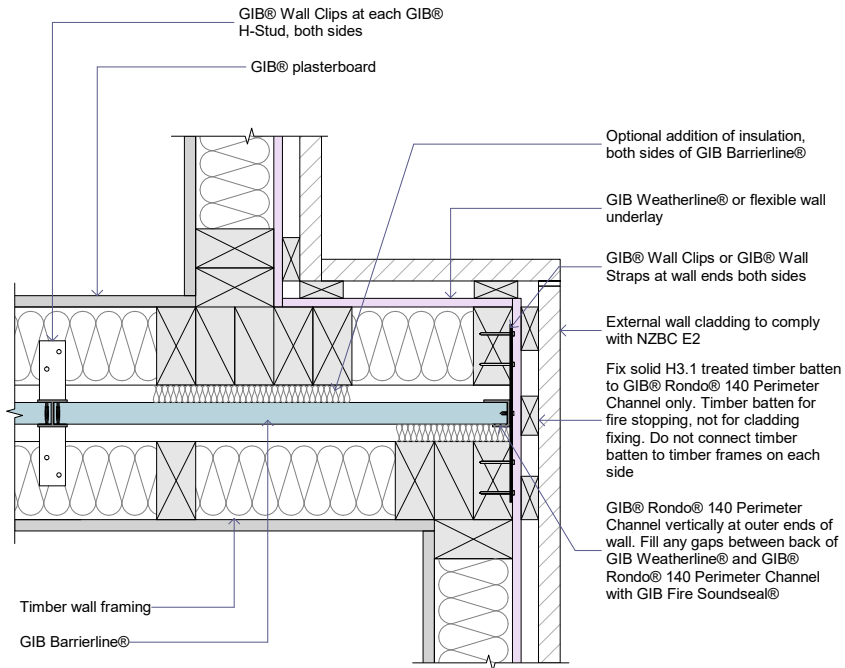

Note: Maximum allowable length of intertenancy wall projection will depend on building height and supporting structure. This will need to be determined by Specific Engineering Design (SED).

GNS331

INTERTENANCY WALL PROJECTION AT EXTERNAL TIMBER FRAME WALL (WITH GIB WEATHERLINE®)

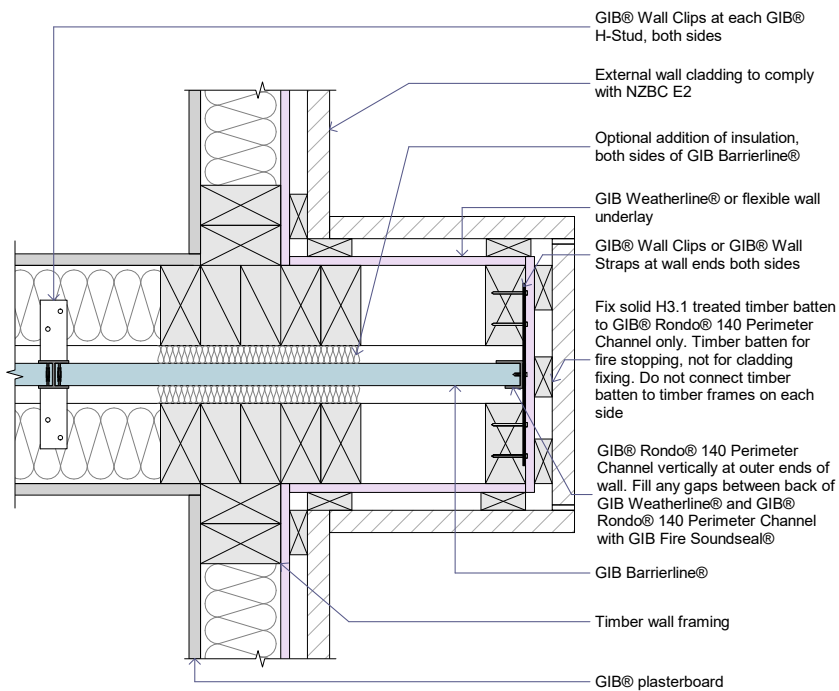

Note: Maximum allowable length of intertenancy wall projection will depend on building height and supporting structure. This will need to be determined by Specific Engineering Design (SED).

GNS124

DETAIL FOR JUNCTION WITH NON-FIRE RELATED WALL

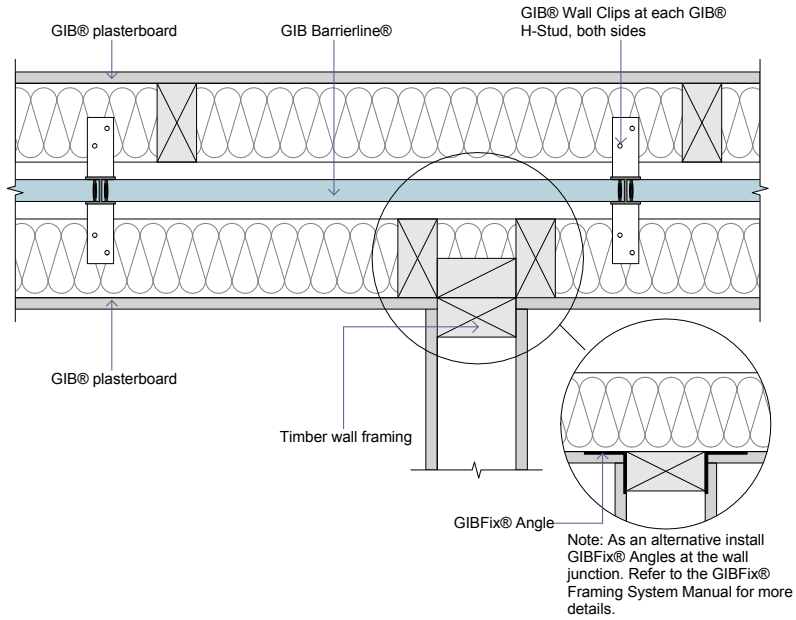

GNS110

DETAIL AT CORNER (PLAN VIEW)

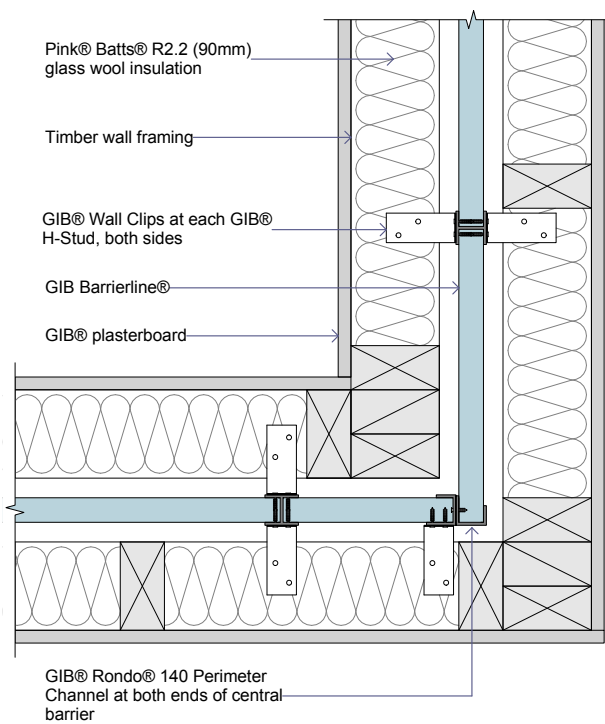

GNS102

MULTI-UNIT JUNCTION - 3 UNITS

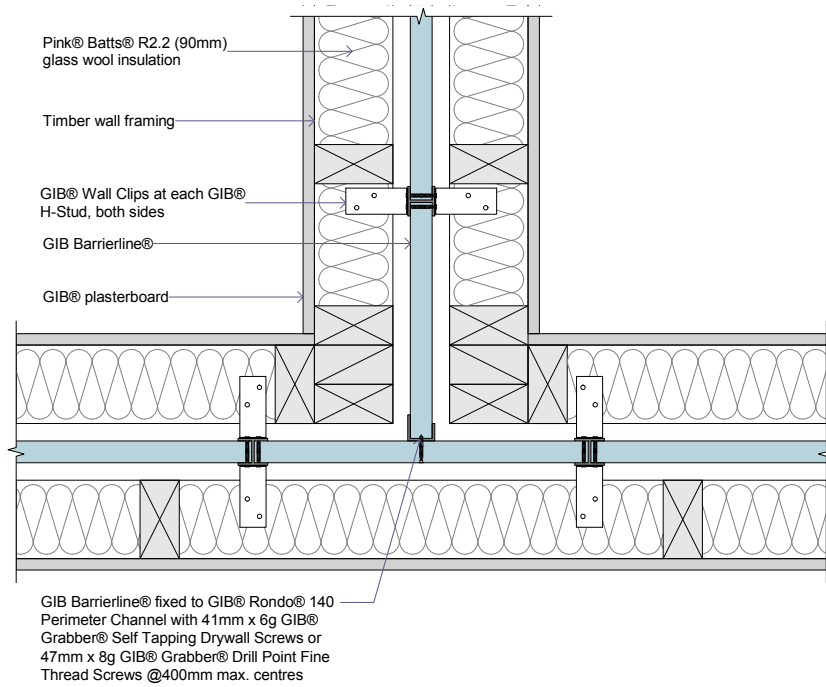

GNS332

MULTI-UNIT JUNCTION - 4 UNITS

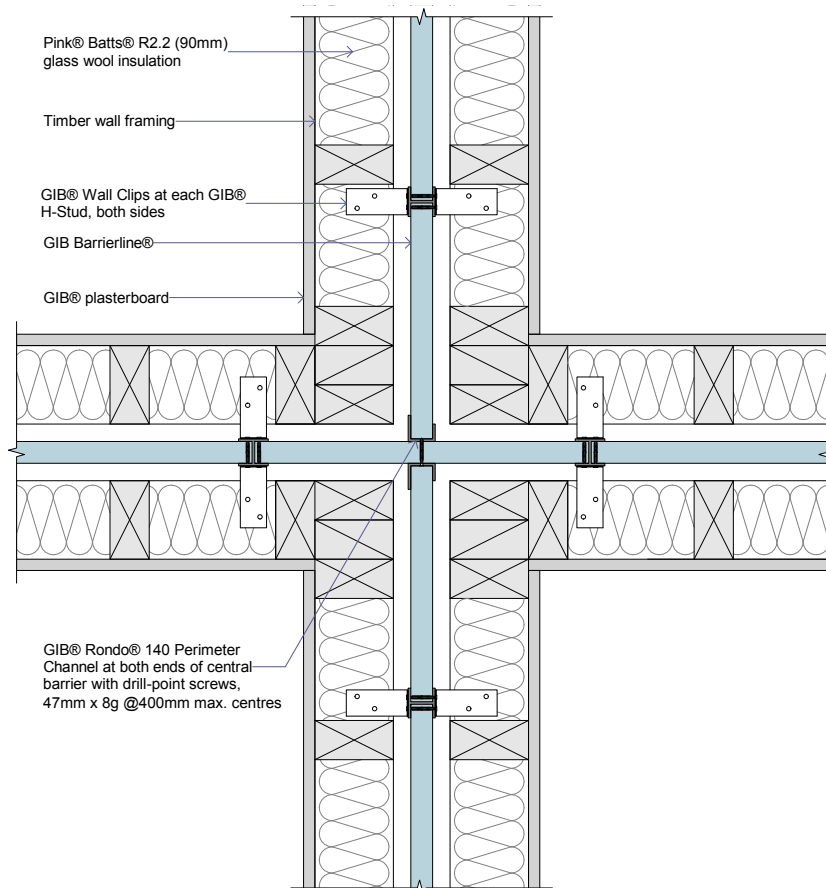

GNS333

CANTILEVERED GIB BARRIERLINE DETAIL – DETAIL SUITABLE FOR CANTILEVER UP TO 1.2M

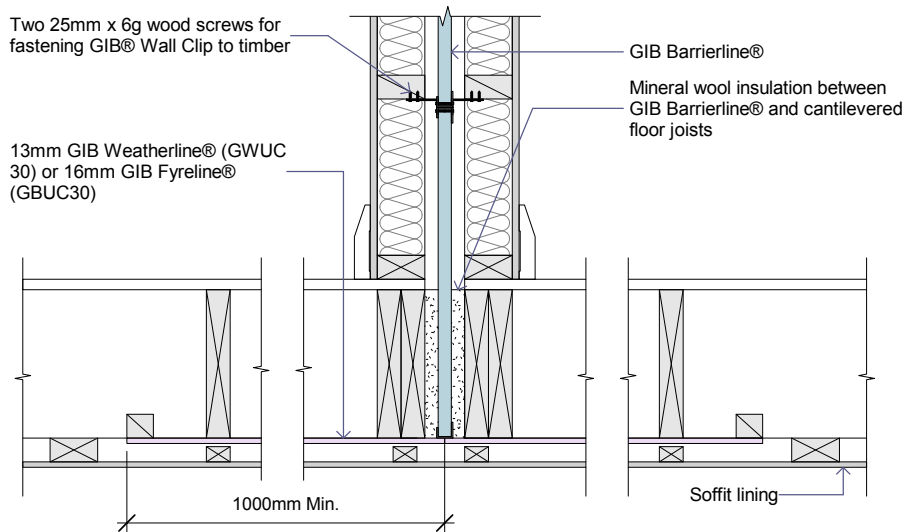

Soffit requires minimum 30/30/30 FRR within 1000mm of property boundary for C/AS1 compliant applications

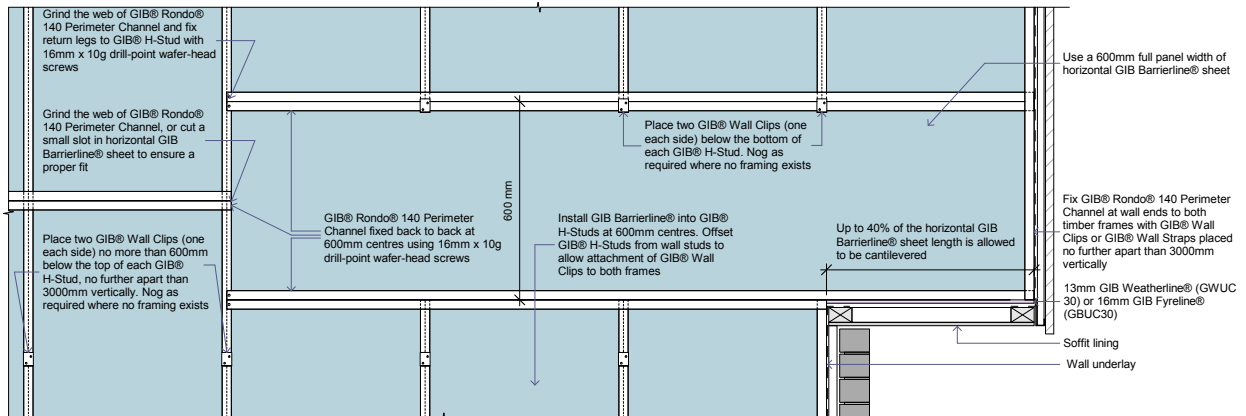

© copyright 2011 Winslow Wallboards Ltd

GNS311



A series of horizontal lines spaced evenly down the page, intended for handwritten notes.

Sustainability and the Environment

Winstone Wallboards is committed to protecting the environment. Environmental matters are integrated into all business activities:

- Our operations strive to exceed all environmental regulatory requirements at all times.
- Protection of the environment is a day to day responsibility that we all must accept.
- We allocate appropriate management time and resources to address relevant environmental issues and continuously improve our activities in that area.
- We will achieve our standards of performance through positive action, employee involvement and constant communication with our neighbours, local authorities and customers.

Minimise on-site waste when designing and/or installing GIB® Systems. For larger projects give consideration to our cut-to-length service to reduce waste. GIB® plasterboard off-cuts, if separated from other waste building materials, can be readily recycled.

For larger projects waste can be diverted to compost manufacturers who grind up the GIB® plasterboard and use it in compost. For smaller projects, the GIB® plasterboard can be ground up and spread around the building site.

GLOBAL GREENTAG^{CERT™}

The Global GreenTag^{Cert™} certified eco-label acknowledges product as meeting the GreenRate Standard set by Global GreenTag^{Cert™}.

GIB® Standard, GIB Fyreline®, GIB Braceline®/Noiseline®, GIB Toughline® and GIB Wideline® hold Level A certification under GreenTag^{Cert™}.

GOOD ENVIRONMENTAL CHOICE AUSTRALIA (GECA)

The following products hold Good Environmental Choice Australia Licence which is a Type 1 Ecolabel program managed in accordance to ISO 14024 'Environmental Labels and Declarations:

GIB Aqualine®, GIB Barrierline, GIB Weatherline®, GIB Toughline® and GIB Toughline® Aqua.

DECLARE CERTIFICATION

Declare is a database of non-toxic, sustainably sourced building products.

Many GIB® plasterboard products including GIB® Standard, GIB Braceline®, GIB Noiseline® and GIB Aqualine® have achieved Red List Free status in Declare certification.

For more information on Winstone Wallboards sustainability commitments visit gib.co.nz.

COPYRIGHT

Copyright © Winstone Wallboards Ltd 2022. All of the material contained in this brochure, including all text, tables, charts, graphs, drawings, images, diagrams are protected by copyright. These materials may not be reproduced, adapted or transmitted in any form by any process, without the permission of Winstone Wallboards Ltd.

Winstone Wallboards asserts its moral rights and reserves all other intellectual property rights in the materials contained in this brochure.

TRADEMARKS

The names GIB®, GIB Barrierline®, GIB Fyreline®, GIB Ultraline®, GIB Braceline®, GIB Toughline®, GIB Noiseline®, GIB Aqualine®, GIB Tradeset®, GIB Plus 4®, GIB-Cove®, GIB Lite Blue®, GIBFix®, the colour mauve for GIB Toughline®, the colour blue for GIB Braceline®, the colour pink for GIB Fyreline®, the colour green for GIB Aqualine®, and the shield device are registered trademarks of Fletcher Building Holdings Limited.

COUNTRY OF ORIGIN

We make GIB® plasterboard in New Zealand*, for New Zealand conditions, giving you 100% certainty.

*Note GIB Barrierline® is manufactured both in New Zealand and to specific specification from a reputable overseas manufacturer.



FOR MORE INFORMATION VISIT

gib.co.nz

OR CALL THE GIB® HELPLINE

0800 100 442