



GIB[®]

Noise Control Systems

Specification and installation manual

CBI5113

SEPTEMBER 2017

NATIONAL SUPPORT

VISIT: Winstone Wallboards Limited
37 Felix Street, Penrose,
Auckland 1061, New Zealand

POST: PO Box 12 256, Penrose,
Auckland 1642, New Zealand

PHONE: +64 9 633 0100

FAX: +64 9 633 0101
Free fax: 0800 229 222

EMAIL: info@gib.co.nz

WEB: gib.co.nz

GIB® HELPLINE

0800 100 442

The New Zealand Building Code sets out minimum standards for noise control between the habitable spaces of household units. But is Code Compliance enough? In today's modern urban environment, people have higher expectations and often demand better protection from noise.

People now rate noise as an important consideration in selecting systems for homes, schools, the workplace and especially in high density and mixed land use areas.

Research shows that many apartment and townhouse owners can be dissatisfied with the level of noise control in their units, even though they meet the code.

Providing above-code noise control in a quality development should have a significant positive effect on value, rental fees, return on investment and resale potential. However, it is important to manage owner/occupant expectations. Noise control does not mean silence and there is no such thing as 'sound proofing'.

This technical document provides noise control systems for designers, specifiers and builders. This information can be used during the building design process to help select systems to achieve the desired level of acoustic comfort.

GIB Noise Control® Systems have been independently tested and evaluated and can be depended on to perform. They represent the best in cost-effective noise control systems.



Noise control systems – intertenancy

	Specification number	LB/NLB	STC	Rw	FRR	Lining requirements	Detail	Page	
Central barrier walls	Timber frame walls – with GIB Barrierline® central barrier								
	GBTLAB 60a	LB	68	66	60/60/60	2 x 10mm GIB® Standard Plasterboard each side		16	
	GBTLAB 60b	LB	64	63	60/60/60	1 x 10mm GIB Braceline®/GIB Noiseline® each side		18	
	GBTLAB 60c	LB	67	65	60/60/60	1 x 13mm GIB Braceline®/GIB Noiseline® each side		20	
	GBTLAB 60d	LB	61	60	60/60/60	1 x 13mm GIB® Standard Plasterboard each side		22	
	Steel frame walls – with GIB Barrierline® central barrier								
	GBSAB 60a	NLB	63	63	-/60/60	1 x 13mm GIB® Standard Plasterboard each side		24	
	GBSAB 60b	NLB	67	66	-/60/60	2 x 13mm GIB® Standard Plasterboard one side 1 x 13mm GIB® Standard Plasterboard other side		26	
	GBSAB 60c	NLB	68	66	-/60/60	1 x 13mm GIB Braceline®/GIB Noiseline® each side		28	
	Staggered stud steel frame walls – with 13mm GIB Fyrelime® central barrier								
	GBSAB 60d	NLB	56	56	-/60/60	1 x 13mm GIB Fyrelime® and 1 x 10mm GIB® Standard Plasterboard each side		30	
	GBSAB 60e	NLB	57	58	-/60/60	1 x 13mm GIB Fyrelime® and 1 x 13mm GIB® Standard Plasterboard each side		32	
	Double frame walls	Double timber frame walls							
		GBTLA 30a	LB	58	57	30/30/30	2 x 10mm GIB® Standard Plasterboard each side		34
GBTLA 30b		LB	58	57	30/30/30	2 x 10mm GIB Braceline®/GIB Noiseline® one side 1 x 10mm GIB Braceline®/GIB Noiseline® other side		35	
GBTLA 60		LB	60	59	60/60/60	2 x 10mm GIB Fyrelime® each side		36	
GBTLA 90c		LB	63	62	90/90/90	2 x 13mm GIB Fyrelime® each side		37	
GBTLA 90d		LB	67	66	90/90/90	2 x 13mm GIB Braceline®/GIB Noiseline® each side		38	
Double steel frame walls									
GBSA 30b		NLB	55	56	-/30/30	1 x 13mm GIB® Standard Plasterboard one side 2 x 13mm GIB® Standard Plasterboard other side		39	
GBSA 60c		NLB	59	58	-/60/60	1 x 13mm GIB Fyrelime® one side 2 x 10mm GIB Braceline®/GIB Noiseline® other side		40	
GBSA 45	NLB	60	59	-/45/45	2 x 13mm GIB® Standard Plasterboard each side		41		

Noise control systems – intertenancy

Double frame walls	Specification number	LB/NLB	STC	Rw	FRR	Lining requirements	Detail	Page
	GBSA 90c	NLB	61	60	-/90/90	2 x 13mm GIB Fyreline® each side		42
GBSA 90d	NLB	65	65	-/90/90	2 x 13mm GIB Braceline®/GIB Noiseline® each side		43	

Timber frame walls – GIB Rail® and acoustic resilient mount									
Single frame walls	GBTLA 45r	LB	55	54	45/45/45	2 x 13mm GIB® Standard Plasterboard each side		44	
	GBTLA 60r	LB	55	54	60/60/60	2 x 10mm GIB Braceline®/GIB Noiseline® each side		45	
	GBTLA 90r	LB	55	55	90/90/90	2 x 13mm GIB Fyreline® each side		46	
	GBTLIC 45	LB	61	59	45/45/45	2 x 13mm GIB® Standard Plasterboard each side		47	
	GBTLIC 60	LB	62	60	60/60/60	2 x 10mm GIB Braceline®/GIB Noiseline® each side		48	
	GBTLIC 60a	LB	57	56	60/60/60	2 x 13mm GIB Braceline®/GIB Noiseline® one side 1 x 13mm GIB Braceline®/GIB Noiseline® other side		49	
	Steel frame walls – GIB Rail® and acoustic resilient mount								
	GBSA 30r	NLB	55	55	-/30/30	2 x 13mm GIB® Standard Plasterboard each side		50	
	GBSA 60r	NLB	55	54	-/60/60	2 x 10mm GIB Braceline®/GIB Noiseline® each side		51	
	GBSA 90r	NLB	57	56	-/90/90	2 x 13mm GIB Fyreline® each side		52	
GBSIC 45a	NLB	55	54	-/45/45	2 x 13mm GIB® Standard Plasterboard each side		53		
Staggered steel stud walls									
GBSA 30s	NLB	55	53	-/30/30	1 x 13mm GIB® Standard Plasterboard one side 2 x 13mm GIB® Standard Plasterboard other side		54		
GBSA 90s	NLB	60	58	-/90/90	1 x 13mm and 1 x 10mm GIB Braceline®/GIB Noiseline® each side		55		
GIB® Rondo® Quiet Stud®									
GBQSA 45	NLB	56	56	-/45/45	2 x 13mm GIB® Standard Plasterboard each side		56		
GBQSA 60a	NLB	55	55	-/60/60	1 x 13mm and 1 x 10mm GIB Braceline®/GIB Noiseline® one side 1 x 13mm GIB Braceline®/GIB Noiseline® on the other side		57		
GBQSA 90	NLB	58	59	-/90/90	1 x 13mm and 1 x 10mm GIB Braceline®/GIB Noiseline® each side		58		

Noise control systems – intertenancy

	Specification number	LB/NLB	STC	IIC*	FRR	Lining requirements	Detail	Page
Floor/ceiling and suspended grid	Floor/ceiling systems							
	GBDFA 60b	LB	57	47	60/60/60	2 x 13mm GIB Fyreline®	Floor ceiling	60
	GBDFA 60d	LB	67	57	60/60/60	2 x 13mm GIB Fyreline®	Floor ceiling	62
	GBDFA 60e	LB	65	56	60/60/60	2 x 13mm GIB Fyreline®	Floor ceiling	64
	GBSJA 45	LB	55	48	45/45/45	2 x 13mm GIB Fyreline®	Floor ceiling	66
	GBSJA 60	LB	56	49	60/60/60	1 x 16mm and 1 x 13mm GIB Fyreline®	Floor ceiling	68
	Suspended grid systems							
	GBSCA 45	LB	56	39	45/45/45	2 x 13mm GIB Fyreline®	Floor ceiling	70
	GBSCA 60a	LB	56	39	60/60/60	1 x 13mm and 1 x 16mm GIB Fyreline®	Floor ceiling	72

* refer to system specification sheet for range of floor covering dependent IIC performance levels.

Noise control systems – sub-intertenancy

	Specification number	LB/NLB	STC	Rw	FRR	Lining requirements	Detail	Page
Single frame walls	GIB® Rondo® Quiet Stud® sub-intertenancy systems							
	GBQSA 30	NLB	52	51	-/30/30	1 x 13mm GIB® Standard Plasterboard one side 2 x 13mm GIB® Standard Plasterboard other side		75
	GBQSA 60	NLB	49	50	-/60/60	1 x 13mm GIB Braceline®/GIB Noiseline® each side		76
	Single steel frame sub-intertenancy systems							
	GSS132	NLB	41	-	-	1 x 13mm GIB® Standard Plasterboard each side		77
	GSS133	NLB	44	-	-	1 x 13mm GIB® Standard Plasterboard one side 2 x 13mm GIB® Standard Plasterboard other side		77
	GSS134	NLB	48	-	-	2 x 13mm GIB® Standard Plasterboard each side		77
	GNS104	NLB	48	-	-	2 x 10mm GIB Braceline®/GIB Noiseline® each side		77
	GNS132	NLB	43	-	-	1 x 13mm GIB Braceline®/GIB Noiseline® each side		77

Noise control systems – sub-intertenancy

	Specification number	LB/NLB	STC	Rw	FRR	Lining requirements	Detail	Page	
Single frame walls	GNS133	NLB	45	–	–	1 x 13mm GIB Braceline®/GIB Noiseline® one side 2 x 13mm GIB Braceline®/GIB Noiseline® other side		77	
	GNS134	NLB	52	–	–	2 x 13mm GIB Braceline®/GIB Noiseline® each side		77	
	Single timber frame sub-intertenancy systems								
	GST102	LB	39	–	–	1 x 10mm GIB® Standard Plasterboard each side		78	
	GST103	LB	42	–	–	1 x 10mm GIB® Standard Plasterboard one side 2 x 10mm GIB® Standard Plasterboard other side		78	
	GST104	LB	44	–	–	2 x 10mm GIB® Standard Plasterboard each side		78	
	GST132	LB	40	–	–	1 x 13mm GIB® Standard Plasterboard each side		78	
	GST133	LB	43	–	–	1 x 13mm GIB® Standard Plasterboard one side 2 x 13mm GIB® Standard Plasterboard other side		78	
	GST134	LB	46	–	–	2 x 13mm GIB® Standard Plasterboard each side		78	
	GNT102	LB	41	–	–	1 x 10mm GIB Braceline®/GIB Noiseline® each side		78	
	GNT103	LB	44	–	–	1 x 10mm GIB Braceline®/GIB Noiseline® one side 2 x 10mm GIB Braceline®/GIB Noiseline® other side		78	
	GNT104	LB	46	–	–	2 x 10mm GIB Braceline®/GIB Noiseline® each side		78	
	GNT132	LB	41	–	–	1 x 13mm GIB Braceline®/GIB Noiseline® each side		78	
	GNT133	LB	46	–	–	1 x 13mm GIB Braceline®/GIB Noiseline® one side 2 x 13mm GIB Braceline®/GIB Noiseline® other side		78	
GNT134	LB	48	–	–	2 x 13mm GIB Braceline®/GIB Noiseline® each side		78		

	Specification number	LB/NLB	STC	IIC*	FRR	Lining requirements	Detail	Page	
Floor/ceiling	Floor/ceiling sub-intertenancy systems								
	GBDFA 30a	LB	53	42	30/30/30	2 x 13mm GIB® Standard Plasterboard	Floor ceiling	80	
	GBDFA 30d	LB	51	41	30/30/30	1 x 13mm GIB Braceline®/GIB Noiseline®	Floor ceiling	82	

* refer to system specification sheet for range of floor covering dependent IIC performance levels.

CONTENTS

Introduction	10	Noise control system – sub-intertenancy	75
Specification reference	10	GIB® Rondo® Quiet Stud® sub-intertenancy systems	75–76
Scope of use	10	Single steel frame sub-intertenancy systems	77
Customised design solutions	10	Single timber frame sub-intertenancy systems	78
Beware of substitution	10	Floor/ceiling sub-intertenancy systems	80–83
Compliance with the NZ Building Code	10	Penetrations in noise control systems	85
Requirements of NZBC Clause G6	10	Introduction	85
Sustainability and the environment	11	Fire Resistance Ratings	85
Global GreenTagCert™	11	How penetrations and fixings degrade noise control	85
Declare certification	11	Building service penetrations in central barrier walls	85
Compatibility with GIB Ezybrace® Systems	11	The importance of sound sealant	85
Wet area linings in GIB Noise Control® Systems	11	Flush boxes	86
GIB Noise Control® Systems supplement	11	Down lights	86
Environmental noise	11	Details	87
BRANZ appraisal	11	Doors	88
When and where to specify noise control	12	GIB Rail® and ST-001 clip installation details	89
The building element	12	Ceiling perimeter details	90
Building connections	12	Timber frame barrier wall details	91–98
Site performance and sound flanking paths	12	Steel frame barrier wall details	99–105
Which framing system to choose?	12	Double timber frame wall details	106–108
Floor joist depth	12	Double steel frame wall details	109–110
Appliances	12	Single timber frame wall details	111–112
Cavity infill	12	Single steel frame wall details	113–114
Steel stud centres and wall heights in GIB Noise Control® Systems	14–15	GIB® Rondo® Quiet Stud® details	115–117
Load-bearing steel stud walls	14	Floor/ceiling details	118–121
Non-load-bearing steel stud walls	14	Ceiling/roof details	122
Table 1: Single studs lined both sides	14	System components	123–126
Table 2: Double studs and resilient rails	15	Double frame GIB® Quiet Tie® systems	127
Table 3: Staggered studs	15	Technical terminology	128
Noise control system – intertenancy	16		
Timber frame walls — with GIB Barrierline® central barrier	16–23		
Steel frame walls — with GIB Barrierline® central barrier	24–29		
Staggered stud steel frame walls — with 13mm			
GIB Fyreline® central barrier	30–33		
Double timber frame walls	34–38		
Double steel frame walls	39–43		
Timber frame walls — GIB Rail® and acoustic resilient mount	44–49		
Steel frame walls — GIB Rail® and acoustic resilient mount	50–53		
Steel frame walls — staggered stud	54–55		
GIB® Rondo® Quiet Stud®	56–58		
Floor/ceiling systems	60–73		



Specification reference example

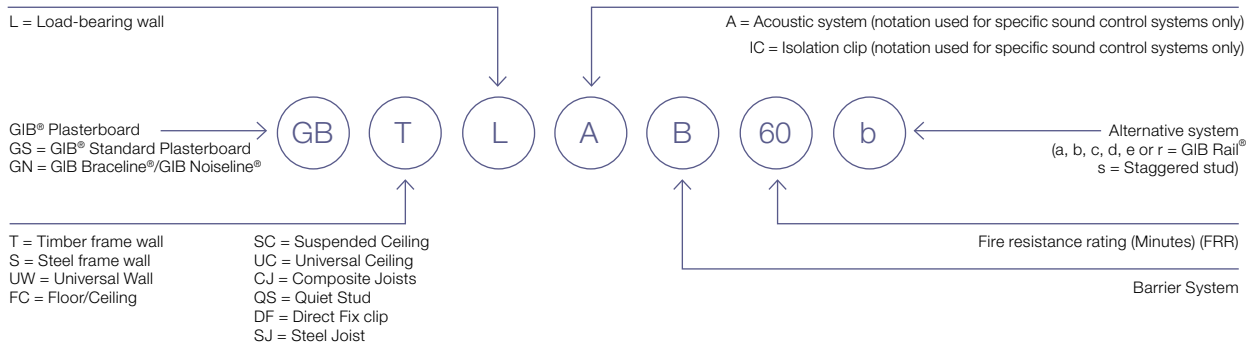

SPECIFICATION REFERENCE

The specification reference allows a quick and precise reference to a particular system.

SCOPE OF USE

GIB Noise Control® Systems are designed to provide noise control solutions for vertical and horizontal building elements. The systems offered include both NZBC compliant, and discretionary levels of performance. The penetration and junction details in this manual are meant to assist specifiers and builders when designing and constructing buildings that incorporate GIB Noise Control® Systems.

CUSTOMISED DESIGN SOLUTIONS

The systems detailed in this book should cover most common situations where noise control is required. However, for projects where specific performance is necessary, GIB® Technical Services can assist you to develop customised noise control solutions. Simply contact us through the GIB® Helpline on 0800 100 442.

BEWARE OF SUBSTITUTION

The performance of noise control systems is very sensitive to design detailing and construction practices. All GIB Noise Control® Systems have been developed specifically for New Zealand conditions and independently tested or assessed to ensure the required level of performance is achieved. Therefore, it is important to use only GIB® branded components where specified and closely follow the specified design details and construction practices, to ensure the required level of noise control is achieved on site.

For further information on substitution please refer to the GIB® Product and System Warranty document that can be found on our website.

COMPLIANCE WITH THE NZ BUILDING CODE

NZBC Clause B1 – Structure

The design and material specification for framing used in conjunction with this manual must be in accordance with the performance requirements for NZBC Clause B1. NZS 3604:2011 is a Compliance Document to NZBC Clause B1.

NZBC Clause B2 – Durability

Under normal conditions of dry internal use the products detailed in GIB Noise Control® Systems have a service life in excess of 50 years and satisfy the requirements of NZBC Clause B2.

NZBC Clauses C1–C6 – Protection from Fire

GIB Noise Control® Systems can be used to provide passive fire protection in accordance with the requirements of NZBC Clause C1–C6 – Protection from Fire

NZBC Clause F2 – Hazardous Building Materials

Under normal conditions of use and serviceable life, the products detailed in GIB Noise Control® Systems do not constitute a health hazard and meet the provisions of the NZBC Clause F2.

NZBC Clause G6 – Airborne and Impact Sound

GIB Noise Control® Systems that appear in the Intertency section of this literature provide airborne and impact noise control ratings that meet or exceed the minimum requirements for NZBC Clause G6 - Airborne and Impact Sound.

REQUIREMENTS OF NZBC CLAUSE G6

The minimum requirements in NZBC Clause G6 between occupancies to 'prevent undue noise transmission from other occupancies or common spaces to household units' are:

- Sound Transmission Class (STC) for walls, floors and ceilings of no less than 55.
- Impact Insulation Class (IIC) for floors of no less than 55.

In this literature, systems that are designed to achieve compliance with this requirement are called 'Intertency' systems. Those that are suitable for non-building code applications i.e. partitions within the same tenancy, are call 'Sub-Intertency' systems.

SUSTAINABILITY AND THE ENVIRONMENT

Winstone Wallboards is committed to protecting the environment. Environmental matters are integrated into all business activities:

- Our operations strive to exceed all environmental regulatory requirements at all times.
- Protection of the environment is a day-to-day responsibility that we must all accept.
- We allocate appropriate management time and resources to address relevant environmental issues and continuously improve our activities in that area.
- We will achieve our standards of performance through positive action, employee involvement and constant communication with our neighbours, local authorities and customers.

Minimise on-site waste when designing and/or installing GIB® Systems. For larger projects give consideration to our cut-to-length service to reduce waste. GIB® plasterboard off-cuts, if separated from other waste building materials, can be readily recycled.

For larger projects, waste can be diverted to compost manufacturers who grind up the GIB® plasterboard and use it in compost. For smaller projects, GIB® plasterboard can be ground up and spread around the building site.

GLOBAL GREENTAGCERT™

The Global GreenTagCert™ certified eco-label acknowledges product as meeting the GreenRate Standard set by Global GreenTagCert™.

Key GIB® plasterboard products are Green Tag Certified.

DECLARE CERTIFICATION

Declare is a database of non-toxic, sustainably sourced building products.

Many GIB® plasterboard products including GIB® Standard, GIB Braceline®/GIB Noiseline®, GIB Fyreline® and GIB Aqualine® have achieved Red List Free status in Declare certification.

For more information on Winstone Wallboards sustainability commitments visit gib.co.nz.

COMPATIBILITY WITH GIB EZYBRACE® SYSTEMS

GIB EzyBrace® Systems are compatible with all GIB Noise Control® Systems that incorporate one or more load bearing timber frames. The exceptions to this rule being GIB Noise Control® Systems that include GIB Raii® and acoustic resilient mounts. These systems are only partially compatible with GIB EzyBrace® Systems.

For GIB Noise Control® Systems with a single layer wall lining the plasterboard bracing element sheets shall be applied directly to the framing with fasteners set out as per the bracing instructions and a fastener length as per the GIB Noise Control® System being installed. The single layer wall lining is to be taped and stopped as per the GIB® Site Guide.

For GIB Noise Control® Systems with a double layer wall lining, the plasterboard bracing element sheets can be either:

- Applied directly to the framing with fasteners set out as per the bracing instructions and a fastener length as per the GIB Noise Control® System being installed. The inner layer can be left unstopped; or
- Applied to the outer sheets with the outer layer fasteners being installed as per the bracing instructions and fastener length as per the GIB Noise Control® System being installed.

The outer layer is to be taped and stopped as per the GIB® Site Guide.

WET AREA LININGS IN GIB NOISE CONTROL® SYSTEMS

If GIB® Standard or GIB Fyreline® is replaced with the equivalent thickness GIB Aqualine®, the FRR and STC ratings will be retained.

If GIB Braceline®/GIB Noiseline® is replaced with the equivalent thickness GIB Aqualine®, the FRR will be retained but the STC rating can reduce as follows;

Original specification	Replacement specification			
	10mm GIB Aqualine®		13mm GIB Aqualine®	
	single layer one side	single layer both sides	single layer one side	single layer both sides
10mm GIB Braceline®/ GIB Noiseline®	-2 STC	-4 STC	No loss	No loss
13mm GIB Braceline®/ GIB Noiseline®	n/a	n/a	-2 STC	-3 STC

GIB NOISE CONTROL® SYSTEMS SUPPLEMENT

From time to time updated information will be communicated via the GIB Noise Control® Systems Supplement, which is available on the GIB® website.

ENVIRONMENTAL NOISE

General information about dealing with environmental noise is available in the GIB Noise Control® Systems Supplement.

BRANZ APPRAISAL

GIB Noise Control® Systems have been appraised by the Building Research Association of New Zealand (BRANZ), Appraisal No. 394 (2017) GIB Noise Control® Systems 2017.

It is of prime importance to comply with the details of design, construction and workmanship in this manual.

THE BUILDING ELEMENT

A system may be chosen once a Fire Resistance Rating (FRR) and the level of noise control (STC and/or IIC) have been determined.

Factors to consider include:

- Footprint or depth — systems can have different total thickness affecting floor space or available height.
- Impact through walls — cupboard doors and knocks on walls are impact sounds. These are best reduced by walls with acoustic isolation (e.g. double frames).

BUILDING CONNECTIONS

It is usually not sufficient to simply specify a building element.

Also consider:

- Junction details: sound travels in all directions — sideways, diagonally, as well as up and down. Suitable junction details must be used to minimise flanking sound.
- Penetration details.
- Services (e.g. HVAC, lifts, plumbing).
- Doors and glazing.
- Where continuous timber flooring occurs performance of wall systems may be limited to less than FSTC 50.

SITE PERFORMANCE AND SOUND FLANKING PATHS

The systems tested in the laboratory are rated using STC or IIC. However, once a system has been installed, a 5 point relaxation is permitted for field testing (FSTC or FIIC). The NZBC requires that both the laboratory and field criteria are complied with.

Sound flanking paths via the surrounding structure must be avoided in order to achieve the published system performance. We recommend engaging a reputable acoustic engineer to provide design advice that will ensure robust on-site noise control performance.

Systems that are predicted to achieve marginal compliance with NZBC require a high degree of care, skill, and site supervision during installation, and should be installed by an experienced person.

Flanking paths, such as floor and wall junctions, must also be robust to ensure they do not contribute to a sub-standard result.

Systems that incorporate a deflection head generally require a ceiling below to achieve full performance.

WHICH FRAMING SYSTEM TO CHOOSE?

This book contains a number of options for constructing intertenancy walls using timber or steel framing. These include single frames, single frames with resilient rail or acoustic resilient mount on one side, staggered studs, double frames and double frames with central barrier.

Although all systems achieved the published STC rating in a laboratory, a similar performance on site is often much harder to attain.

- Single stud systems may be used in situations where the wall is installed between concrete floors and where there are no intersecting walls, penetrations, or any fittings (e.g. kitchen joinery) connected to the wall. Minor deviations from the specification or inaccuracies in construction can result in a significant performance loss. Single stud systems are not generally recommended for intertenancy construction.

- Resilient single steel stud systems (GIB® Rondo® Quiet Stud®) are less prone to site variations.
- With resilient rail systems, extreme care must be taken not to bridge the gap between the linings and the framing on the resilient rail side. This can happen by accidentally screw fixing through the rail into the stud, the use of packers to connect joinery, mounting of electrical switch boxes, etc. Flanking paths can also be easily created at wall and floor ceiling junctions. Competent installation and supervision is required when constructing systems with GIB Rail®.
- Staggered stud, double frames and double frames with central barrier deliver by far the most reliable on-site performance and are generally recommended for intertenancy construction. When connections between the frames are required for fire stability or structural reasons, these must be designed with care. Structural connections, such as continuous timber flooring, can reduce the FSTC rating of double stud intertenancy walls.

FLOOR JOIST DEPTH

Some floor/ceiling systems were tested with floor joist depths of 190–240mm. The STC and IIC values of these systems will remain unchanged when the joists are reduced to 140mm deep.

APPLIANCES

Washing machines, wall-mounted driers and speaker boxes, TVs, and even some light switches, transmit sound vibration into the structure. It is easy for this structure-borne sound to then be transmitted to adjacent occupancies.

Following these simple rules will minimise the risk of noise problems:

- Do not mount appliances on intertenancy walls.
- Locate driers and the like on external walls or other non-critical walls. When positioned on the floor, place on resilient mountings.
- Do not mount TVs or speaker boxes on critical intertenancy walls or on partition walls within the unit that separate living areas, such as the lounge, from quiet zones such as a study or a bedroom.
- Never mount electrical outlets back-to-back. This rule does not apply to double frame central barrier systems.

CAVITY INFILL

GIB Noise Control® Systems are typically specified with Pink® Batts® glass wool insulation with a density of 9.6kg/m³. When substitution of infill takes place, independent verification must be obtained to confirm that the noise control performance of the system will be maintained.

At time of installation care must be taken not to compress the infill because this may create an acoustic bridge between the wall linings. For example, this can be avoided by neatly slicing the infill material to fit around building services that may be present in the wall or ceiling cavity. Failure to do this may adversely affect the noise control performance of the system.



LOAD-BEARING STEEL STUD WALLS

Stud type and centres as well as allowable height for loadbearing steel frame systems are the subject of specific engineering design.

The noise control performance of loadbearing double stud systems, GIB Rail® systems, and acoustic resilient mount systems, is similar to the STC and Rw ratings published for the equivalent non-loadbearing steel frame specifications published in this technical literature.

The Fire Resistance Rating (FRR) of load-bearing steel frame systems can be obtained by referring to 'GBSL' specifications published in the latest issue of the 'GIB® Fire Rated Systems' literature, or by specific engineering design when the applied stud load at the time of a fire and the ambient capacity are known.

NON-LOAD-BEARING STEEL STUD WALLS

Steel stud framing sizes and wall heights for non-load-bearing studs in GIB Noise Control® Systems. Studs lined both sides. Follow the framing supplier's nogging requirements.

Steel stud sizes and wall heights for non-load-bearing wall frames in GIB Noise Control® Systems depend on factors such as:

- Differential pressures and/or wall impact forces.
- Fire resistance requirements and associated thermal deformations, and
- Lining one or both sides of the frame, with associated connections, noggings, etc.

The following tables are a guide to maximum permitted wall height as a function of stud size and centres. The tables are intended for internal walls only and refer to GIB Noise Control® System specifications in this publication. Specific design is required for applications outside the basis for design of these tables.

The basis for design includes:

- Deflection limit at 0.25 kPa is span/240 to a maximum of 30mm.
- P ultimate = 0.375 kPa.
- P serviceability = 0.250 kPa.
- Fire design considerations¹.

Tiled walls may require a lower deflection limit.

¹ Fire design involves assessment of furnace test results and wall deflections as a function of thermal gradients, stud depth and wall height. These considerations often govern the design of fire rated steel stud wall assemblies. Results can thus be more conservative than standard framing tables published by steel stud manufacturers.

TABLE 1: SINGLE STUDS LINED BOTH SIDES

Steel stud framing sizes and wall heights for non-load-bearing studs in GIB Noise Control® Systems. Studs lined both sides. Follow the framing supplier's nogging requirements.

Nominal stud dimensions (mm)	Minimum Base Metal Thickness** (BMT) (mm)	Stud centres (mm)	Maximum wall height (mm)	Expansion tolerance at top of studs (mm)
64 x 34	0.50 or 0.55	600	3000	15
		400	3200	15
76 x 34	0.55	600	3200	15
		400	3800	20*
	0.75	600	3600	20*
		400	4200	20*
92 x 34	0.55	600	3800	20*
		400	4200	20*
	0.75	600	4200	20*
		400	4800	25*
GIB® Rondo® Quiet Stud® 92 x 45	0.55	600	3800	20*
		400	4200	20*

* use a minimum 50mm deep head channel.

** increasing the steel stud BMT to 0.75mm will lower the stated noise control performance of the following single stud specifications GSS132, GSS133, GSS134, GNS132, GNS133, GNS104 and GNS134.

Table 1 can be applied to single stud system specifications GBQSA45, GBQSA60a, GBQSA90, GBQSA30, GBQSA60, GSS132, GSS133, GSS134, GNS132, GNS133, GNS104 and GNS134.

TABLE 2: DOUBLE STUDS, RESILIENT RAILS AND ACOUSTIC RESILIENT MOUNTS

Steel stud framing sizes and wall heights for non-load-bearing studs in GIB Noise Control® Systems. Studs lined one side. Follow the framing supplier's nogging requirements.

Nominal stud dimensions (mm)	Minimum Base Metal Thickness (BMT) (mm)	Stud centres (mm)	Maximum wall height (mm)	Expansion tolerance at top of studs (mm)
64 x 34	0.50 or 0.55	600	2700	15
		400	3000	15
76 x 34	0.55	600	3200	15
		400	3600	20*
	0.75	600	3600	20*
		400	4200	20*
92 x 34	0.55	600	3600	20*
		400	4200	20*
	0.75	600	4200	20*
		400	4800	25*

* use a minimum 50mm deep head channel.

Table 2 can be applied to central barrier system specifications GBSAB60a, GBSAB60b and GBSAB60c. Table 2 can also be applied to double stud system specifications GBSA30b, GBSA45, GBSA60c, GBSA90c, GBSA90d, and steel stud plus resilient rail and acoustic resilient mount system specifications GBSA 30r, GBSA60r, GBSA90r and GBSIC30a.

TABLE 3: STAGGERED STUDS

Steel stud framing sizes and wall heights for non-load-bearing studs in GIB Noise Control® Systems. Staggered studs lined one side. No noggings.

Frame spacing indicates the stud centres supporting the linings on one face. The same stud spacing applies on the opposite side of the frame. When taking into account studs on both sides of the frame, the stud centres are half those indicated below.

Nominal stud dimensions (mm)	Minimum Base Metal Thickness (BMT) (mm)	Stud centres (mm)	Maximum wall height (mm)	Expansion tolerance at top of studs (mm)
64 x 34	0.50 or 0.55	600	2400	15
		400	2700	15
76 x 34	0.55	600	2600	15
		400	2900	15
	0.75	600	3000	15
		400	3500	20*
92 x 34	0.55	600	2700	15
		400	3100	15
	0.75	600	3200	20*
		400	3700	20*

* use a minimum 50mm deep head channel.

Table 3 can be applied to staggered stud system specifications GBSA30s and GBSA90s.

Two way FRR – double timber frame with GIB Barrierline® central barrier

Specification number	Performance	Specifications
GBTLAB 60a	STC 68 Rw 66 FRR 60/60/60	Lining 2 x 10mm GIB® Standard Plasterboard each side LB/NLB Load bearing Partition 300–330mm wide

TIMBER FRAMING

Stud size	Space between frames
90mm	80–110mm

Framing to comply with:

- NZBC B1 – Structure: AS1 Clause 3 – Timber (NZS 3604) or VM1 Clause 6 – Timber (NZS 3603).
- NZBC B2 – Durability: AS1 Clause 3.2 – Timber (NZS 3602).

Maximum height as determined by NZS 3604 stud and top plate tables for load-bearing walls.

CENTRAL BARRIER

- Allow a 25–40mm gap between each timber frame and the GIB Barrierline® central barrier.
- Fix GIB® Rondo® 140 Perimeter Channels to the concrete floor with steel fasteners at 600mm centres and no more than 50mm from channel ends using 3.5mm x 30mm or 4.0mm x 25mm concrete nails or 6mm x 40mm concrete anchors.
- A 5mm gap between GIB® Rondo® 140 Perimeter Channels will let any collected rain water escape.
- GIB® Rondo® 140 Perimeter Channel to be sealed to the floor slab on one side with fire/acoustic sealant.
- Install 25mm GIB Barrierline® into GIB® H-Studs at 600mm centres.
- Cap GIB Barrierline® ends with GIB® Rondo® 140 Perimeter Channel.
- Offset GIB® H-Studs at least 100mm from wall studs to allow attachment of GIB® Wall Clips to both frames. Nog as required where no framing exists.
- Place two GIB® Wall Clips (one each side) no more than 600mm below the top of each GIB® H-Stud, no further apart than 3000mm vertically.
- Fix GIB® Rondo® 140 Perimeter Channel at wall ends to both timber frames with GIB® Wall Clips or GIB® Wall Straps placed no further apart than 3000mm vertically.
- Use no more than two GIB® Wall Clips or GIB® Wall Straps (one each side) for each 3000mm length of GIB® H-Stud or GIB® Rondo® 140 Perimeter Channel.
- In the roof space, fix 16mm GIB Fyreline® to one side of the GIB Barrierline® with 40mm x 8g chipboard screws on a 400mm grid, and at no more than 100mm from sheet edges.
- Extend the 16mm GIB Fyreline® at least 200mm below ceiling level.
- Once erected, protect the GIB Barrierline® and GIB Fyreline® from rain. The use of suitable sheeting can avoid delays in allowing the board to dry before wall linings are installed.

SOUND CONTROL INFILL

Install Pink® Batts® R2.2 (90mm) glass wool insulation between the studs and nogs in both frames.

WALL LINING

2 layers of 10mm GIB® Standard each side.

Fix inner sheets vertically. Where sheet end butt joints are unavoidable they must be formed over framing. Use full height sheets where possible.

Outer layer sheets can be fixed vertically or horizontally. If fixed vertically, outer layer sheet joints must be offset 600mm from those of the inner layer. Use full height sheets where possible.

If the wall lining forms part of the structural bracing system, the inner layer lining type and fixings must comply with the published bracing system. Check requirements for specific bracing element hold-down connections.

FASTENING THE LINING

Fasteners

Inner layer: 32mm x 6g GIB® Grabber® High Thread Drywall Screws.

Outer layer: 41mm x 6g GIB® Grabber® High Thread Drywall Screws.

Fastener centres

Fix inner layer sheets to each stud and plate with fasteners at 300mm centres. When fixing outer layer sheets vertically, offset sheet joints from the inner layer. Fix the perimeter of each outer layer sheet to the frame with fasteners at 300mm centres. Adhesive fix the outer layer to the inner layer with daubs of GIBFix® adhesive down the centre line at 300mm centres. Do not place GIBFix® adhesive at sheet edges or within 200mm of screw fixings.

If fixing outer layer sheets horizontally, fasteners to be placed at 300mm centres to top and bottom plates and perimeter studs. Install pairs of single fasteners to each stud where the horizontal joint crosses. Adhesive fix the outer layer to the inner layer with daubs of GIBFix® adhesive down the centre line at 300mm centres. Do not place GIBFix® adhesive at sheet edges or within 200mm of screw fixings.

Place screws no closer than 12mm from paperbound sheet edges and 18mm from any sheet end or cut edge.

BUILDING SERVICE PENETRATIONS

Plumbing and electrical services are permitted in the cavities either side of the central barrier. Back-to-back services and penetrations are permitted within the limitations given below. A minimum of 10mm clearance must be provided between plumbing or electrical services and the central barrier.

Metal and PVC plumbing services up to 65mm diameter do not need specialist fire-stopping where they penetrate the wall linings. Penetrations through wall linings must have neatly cut holes with

Two way FRR – double timber frame with GIB Barrierline® central barrier

Specification number	Performance	Specifications
GBTLAB 60a	STC 68	Lining 2 x 10mm GIB® Standard Plasterboard each side
	Rw 66	LB/NLB Load bearing
	FRR 60/60/60	Partition 300–330mm wide

6mm maximum clearance around the plumbing service. Fill the gap with general purpose flexible sealant.

Electrical services up to 90 x 50mm that penetrate wall linings do not need to be fire-stopped. Limit flush boxes to two per nominally 600mm wide stud bay.

Suitable proprietary fire-stopping is required for larger penetrations, and for penetrations through the GIB Barrierline® central barrier. Penetrating the GIB Barrierline® central barrier may reduce the noise control performance of the system.

WET AREA WALL LINING

If the outer layer of 10mm GIB® Standard Plasterboard wall lining is substituted with 10mm GIB Aqualine®, the FRR and noise control rating will be retained.

Place two GIB® Wall Clips (one each side) no more than 600mm below the top of each GIB® H-Stud, no further apart than 3000mm vertically
2 layers 10mm GIB® Standard Plasterboard

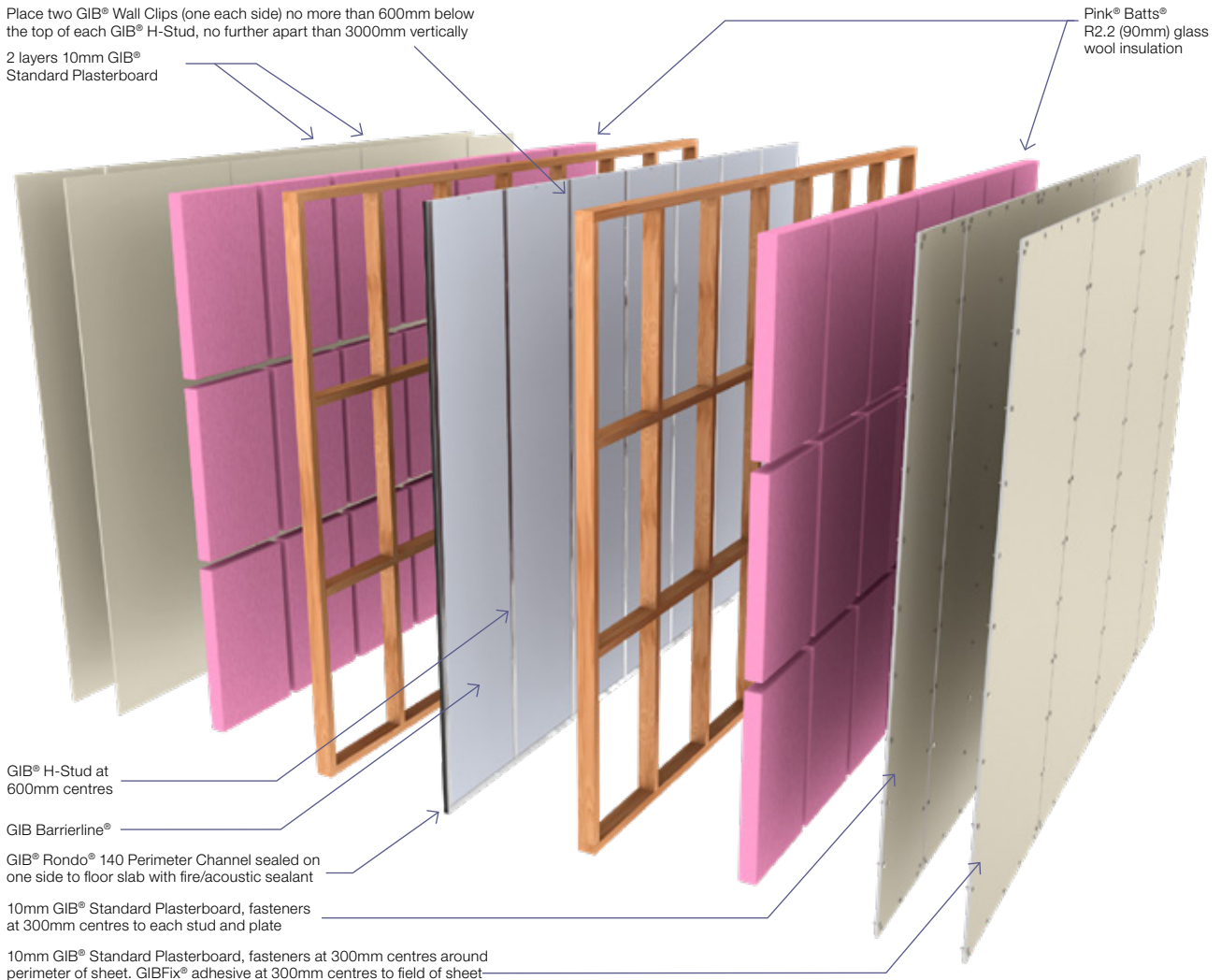

JOINTING

Central Barrier: Unstopped.

Inner layer wall lining: Unstopped.

Outer layer wall lining: All fastener heads stopped and all sheet joints tape reinforced and stopped in accordance with the publication entitled GIB® Site Guide. Wall to ceiling junctions are to be reinforced with paper tape and square stopped or finished with GIB-Cove®.

SUPPLEMENTARY MATERIAL

For additional information on this system refer to the GIB® Intertenancy Barrier Systems for Terrace Homes Specification and Installation Manual.

Two way FRR – double timber frame with GIB Barrierline® central barrier

Specification number	Performance	Specifications
GBTLAB 60b	STC 64 Rw 63 FRR 60/60/60	Lining 1 x 10mm GIB Braceline®/GIB Noiseline® each side LB/NLB Load bearing Partition 280–310mm wide

TIMBER FRAMING

Stud size	Space between frames
90mm	80–110mm

Framing to comply with:

- NZBC B1 – Structure: AS1 Clause 3 – Timber (NZS 3604) or VM1 Clause 6 – Timber (NZS 3603).
- NZBC B2 – Durability: AS1 Clause 3.2 – Timber (NZS 3602).

Maximum height as determined by NZS 3604 stud and top plate tables for load-bearing walls.

CENTRAL BARRIER

- Allow a 25–40mm gap between each timber frame and the GIB Barrierline® central barrier.
- Fix GIB® Rondo® 140 Perimeter Channels to the concrete floor with steel fasteners at 600mm centres and no more than 50mm from channel ends using 3.5mm x 30mm or 4.0mm x 25mm concrete nails or 6mm x 40mm concrete anchors.
- A 5mm gap between GIB® Rondo® 140 Perimeter Channels will let any collected rain water escape.
- GIB® Rondo® 140 Perimeter Channel to be sealed to the floor slab on one side with fire/acoustic sealant.
- Install 25mm GIB Barrierline® into GIB® H-Studs at 600mm centres.
- Cap GIB Barrierline® ends with GIB® Rondo® 140 Perimeter Channel.
- Offset GIB® H-Studs at least 100mm from wall studs to allow attachment of GIB® Wall Clips to both frames. Nog as required where no framing exists.
- Place two GIB® Wall Clips (one each side) no more than 600mm below the top of each GIB® H-Stud, no further apart than 3000mm vertically.
- Fix GIB® Rondo® 140 Perimeter Channel at wall ends to both timber frames with GIB® Wall Clips or GIB® Wall Straps placed no further apart than 3000mm vertically.
- Use no more than two GIB® Wall Clips or GIB® Wall Straps (one each side) for each 3000mm length of GIB® H-Stud or GIB® Rondo® 140 Perimeter Channel.
- In the roof space, fix 16mm GIB Fyrelite® to one side of the GIB Barrierline® with 40mm x 8g chipboard screws on a 400mm grid, and at no more than 100mm from sheet edges.
- Extend the 16mm GIB Fyrelite® at least 200mm below ceiling level.
- Once erected, protect the GIB Barrierline® and GIB Fyrelite® from rain. The use of suitable sheeting can avoid delays in allowing the board to dry before wall linings are installed.

SOUND CONTROL INFILL

Install Pink® Batts® R2.2 (90mm) glass wool insulation between the studs and nogs in both frames.

WALL LINING

A single layer of 10mm GIB Braceline®/GIB Noiseline® fixed vertically or horizontally.

Use full height sheets where possible.

Sheet joints are touch fitted and must occur over framing.

Where sheet end butt joints are unavoidable they must be formed over framing.

If the wall lining forms part of the structural bracing system, the lining type and fixings must comply with the published bracing system. Check requirements for specific bracing element hold-down connections.

FASTENING THE LINING

Fasteners

32mm x 6g GIB® Grabber® High Thread Drywall Screws.

Fastener centres

300mm centres to each stud and plate. Place screws no closer than 12mm from paperbound edges and 18mm from any sheet end or cut edges.

BUILDING SERVICE PENETRATIONS

Plumbing and electrical services are permitted in the cavities either side of the central barrier. Back-to-back services and penetrations are permitted within the limitations given below. A minimum of 10mm clearance must be provided between plumbing or electrical services and the central barrier.

Metal and PVC plumbing services up to 65mm diameter do not need specialist fire-stopping where they penetrate the wall linings. Penetrations through wall linings must have neatly cut holes with 6mm maximum clearance around the plumbing service. Fill the gap with general purpose flexible sealant.

Electrical services up to 90 x 50mm that penetrate wall linings do not need to be fire-stopped. Limit flush boxes to two per nominally 600mm wide stud bay.

Suitable proprietary fire-stopping is required for larger penetrations, and for penetrations through the GIB Barrierline® central barrier. Penetrating the GIB Barrierline® central barrier may reduce the noise control performance of the system.

Two way FRR – double timber frame with GIB Barrierline® central barrier

Specification number	Performance	Specifications
GBTLAB 60b	STC 64	Lining 1 x 10mm GIB Braceline®/GIB Noiseline® each side
	Rw 63	LB/NLB Load bearing
	FRR 60/60/60	Partition 280–310mm wide

WET AREA WALL LINING

If the 10mm GIB Braceline®/GIB Noiseline® wall lining is substituted with 10mm GIB Aqualine® on both sides, the FRR will be retained but a noise control reduction of 4 STC/Rw points can be expected.

If the 10mm GIB Braceline®/GIB Noiseline® wall lining is substituted with 13mm GIB Aqualine®, the FRR and noise control rating will be maintained.

JOINTING

Central Barrier: Unstopped.

Wall lining: All fastener heads stopped and all sheet joints tape reinforced and stopped in accordance with the publication entitled GIB® Site Guide. Wall to ceiling junctions are to be reinforced with paper tape and square stopped or finished with GIB-Cove®.

SUPPLEMENTARY MATERIAL

For additional information on this system refer to the GIB® Intertency Barrier Systems for Terrace Homes Specification and Installation Manual.

Place two GIB® Wall Clips (one each side) no more than 600mm below the top of each GIB® H-Stud, no further apart than 3000mm vertically

10mm GIB Braceline®/
GIB Noiseline®

Pink® Batts®
R2.2 (90mm) glass
wool insulation

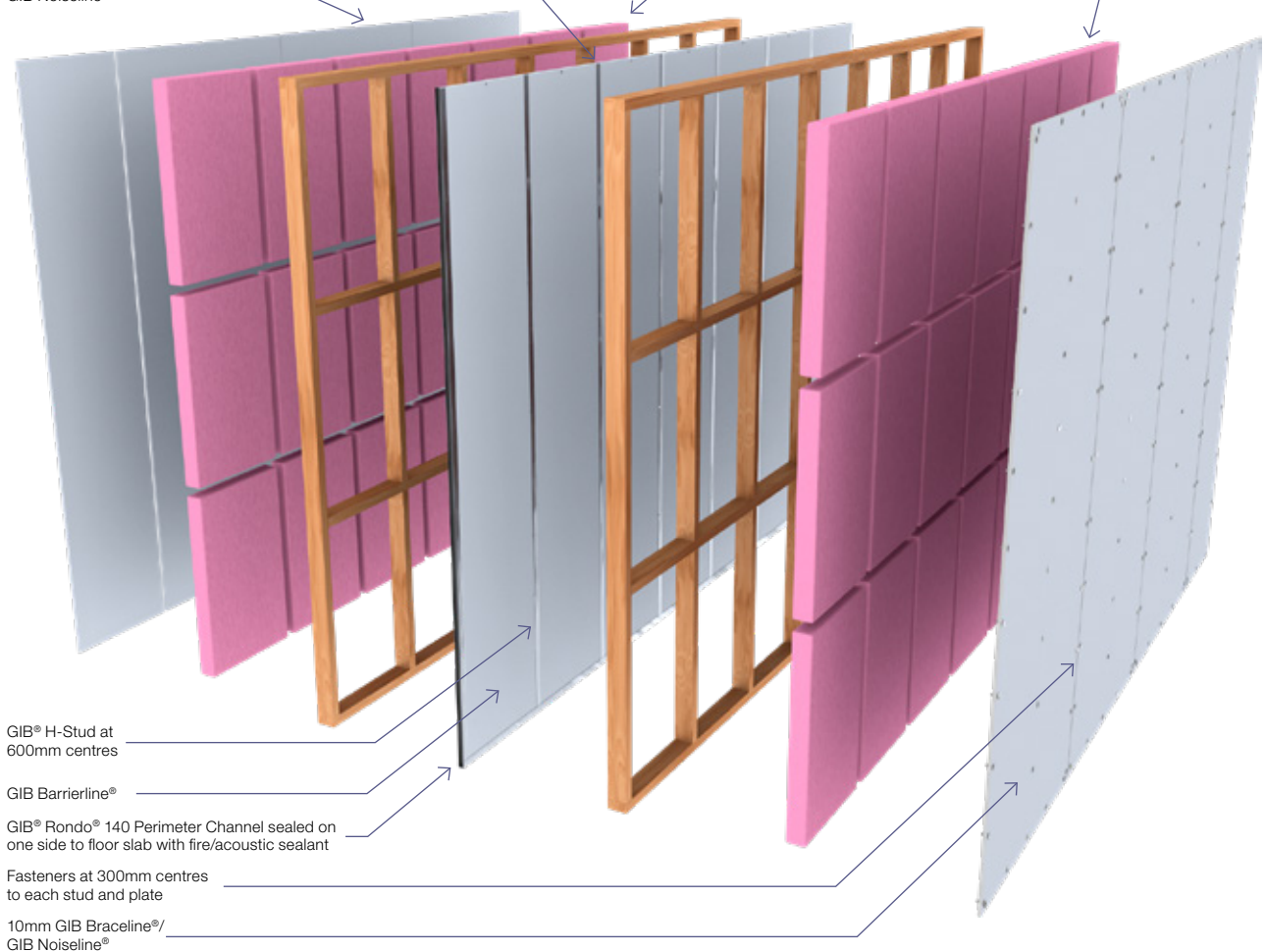

GIB® H-Stud at
600mm centres

GIB Barrierline®

GIB® Rondo® 140 Perimeter Channel sealed on
one side to floor slab with fire/acoustic sealant

Fasteners at 300mm centres
to each stud and plate

10mm GIB Braceline®/
GIB Noiseline®

Two way FRR – double timber frame with GIB Barrierline® central barrier

Specification number	Performance	Specifications
GBTLAB 60c	STC 67 Rw 65 FRR 60/60/60	Lining 1 x 13mm GIB Braceline®/GIB Noiseline® each side LB/NLB Load bearing Partition 286–316mm wide

TIMBER FRAMING

Stud size	Space between frames
90mm	80–110mm

Framing to comply with:

- NZBC B1 – Structure: AS1 Clause 3 – Timber (NZS 3604) or VM1 Clause 6 – Timber (NZS 3603).
- NZBC B2 – Durability: AS1 Clause 3.2 – Timber (NZS 3602).

Maximum height as determined by NZS 3604 stud and top plate tables for load-bearing walls.

CENTRAL BARRIER

- Allow a 25–40mm gap between each timber frame and the GIB Barrierline® central barrier.
- Fix GIB® Rondo® 140 Perimeter Channels to the concrete floor with steel fasteners at 600mm centres and no more than 50mm from channel ends using 3.5mm x 30mm or 4.0mm x 25mm concrete nails or 6mm x 40mm concrete anchors.
- A 5mm gap between GIB® Rondo® 140 Perimeter Channels will let any collected rain water escape.
- GIB® Rondo® 140 Perimeter Channel to be sealed to the floor slab on one side with fire/acoustic sealant.
- Install 25mm GIB Barrierline® into GIB® H-Studs at 600mm centres.
- Cap GIB Barrierline® ends with GIB® Rondo® 140 Perimeter Channel.
- Offset GIB® H-Studs at least 100mm from wall studs to allow attachment of GIB® Wall Clips to both frames. Nog as required where no framing exists.
- Place two GIB® Wall Clips (one each side) no more than 600mm below the top of each GIB® H-Stud, no further apart than 3000mm vertically.
- Fix GIB® Rondo® 140 Perimeter Channel at wall ends to both timber frames with GIB® Wall Clips or GIB® Wall Straps placed no further apart than 3000mm vertically.
- Use no more than two GIB® Wall Clips or GIB® Wall Straps (one each side) for each 3000mm length of GIB® H-Stud or GIB® Rondo® 140 Perimeter Channel.
- In the roof space, fix 16mm GIB Fyreline® to one side of the GIB Barrierline® with 40mm x 8g chipboard screws on a 400mm grid, and at no more than 100mm from sheet edges.
- Extend the 16mm GIB Fyreline® at least 200mm below ceiling level.
- Once erected, protect the GIB Barrierline® and GIB Fyreline® from rain. The use of suitable sheeting can avoid delays in allowing the board to dry before wall linings are installed.

SOUND CONTROL INFILL

Install Pink® Batts® R2.2 (90mm) glass wool insulation between the studs and nogs in both frames.

WALL LINING

A single layer of 13mm GIB Braceline®/GIB Noiseline® fixed vertically or horizontally.

Use full height sheets where possible.

Sheet joints are touch fitted and must occur over framing.

Where sheet end butt joints are unavoidable they must be formed over framing.

If the wall lining forms part of the structural bracing system, the lining type and fixings must comply with the published bracing system. Check requirements for specific bracing element hold-down connections.

FASTENING THE LINING

Fasteners

32mm x 6g GIB® Grabber® High Thread Drywall Screws.

Fastener centres

300mm centres to each stud and plate. Place screws no closer than 12mm from paperbound edges and 18mm from any sheet end or cut edges.

BUILDING SERVICE PENETRATIONS

Plumbing and electrical services are permitted in the cavities either side of the central barrier. Back-to-back services and penetrations are permitted within the limitations given below. A minimum of 10mm clearance must be provided between plumbing or electrical services and the central barrier.

Metal and PVC plumbing services up to 65mm diameter do not need specialist fire-stopping where they penetrate the wall linings. Penetrations through wall linings must have neatly cut holes with 6mm maximum clearance around the plumbing service. Fill the gap with general purpose flexible sealant.

Electrical services up to 90 x 50mm that penetrate wall linings do not need to be fire-stopped. Limit flush boxes to two per nominally 600mm wide stud bay.

Suitable proprietary fire-stopping is required for larger penetrations, and for penetrations through the GIB Barrierline® central barrier. Penetrating the GIB Barrierline® central barrier may reduce the noise control performance of the system.

WET AREA WALL LINING

If the 13mm GIB Braceline®/GIB Noiseline® wall lining is substituted with 13mm GIB Aqualine® on both sides, the FRR will be retained but a noise control reduction of 3 STC/Rw points can be expected.

Two way FRR – double timber frame with GIB Barrierline® central barrier

Specification number	Performance	Specifications
GBTLAB 60c	STC 67	Lining 1 x 13mm GIB Braceline®/GIB Noiseline® each side
	Rw 65	LB/NLB Load bearing
	FRR 60/60/60	Partition 286–316mm wide

JOINTING

Central Barrier: Unstopped.

Wall lining: All fastener heads stopped and all sheet joints tape reinforced and stopped in accordance with the publication entitled GIB® Site Guide. Wall to ceiling junctions are to be reinforced with paper tape and square stopped or finished with GIB-Cove®.

SUPPLEMENTARY MATERIAL

For additional information on this system refer to the GIB® Intertenancy Barrier Systems for Terrace Homes Specification and Installation Manual.

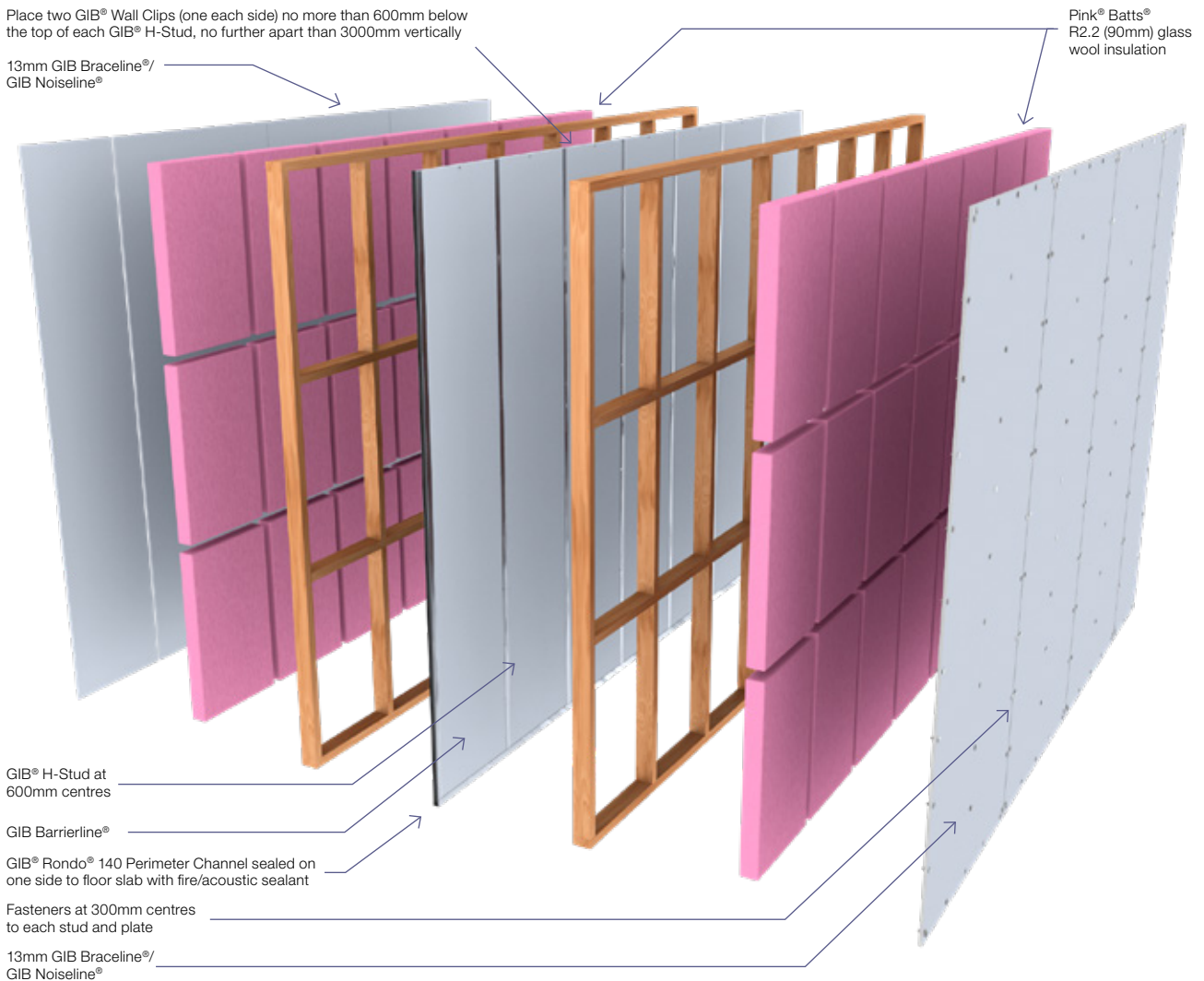

Two way FRR – double timber frame with GIB Barrierline® central barrier

Specification number	Performance	Specifications
GBTLAB 60d	STC 61 Rw 60 FRR 60/60/60	Lining 1 x 13mm GIB® Standard Plasterboard each side LB/NLB Load bearing Partition 286–316mm wide

TIMBER FRAMING

Stud size	Space between frames
90mm	80–110mm

Framing to comply with:

- NZBC B1 – Structure: AS1 Clause 3 – Timber (NZS 3604) or VM1 Clause 6 – Timber (NZS 3603).
- NZBC B2 – Durability: AS1 Clause 3.2 – Timber (NZS 3602).

Maximum height as determined by NZS 3604 stud and top plate tables for load-bearing walls.

CENTRAL BARRIER

- Allow a 25–40mm gap between each timber frame and the GIB Barrierline® central barrier.
- Fix GIB® Rondo® 140 Perimeter Channels to the concrete floor with steel fasteners at 600mm centres and no more than 50mm from channel ends using 3.5mm x 30mm or 4.0mm x 25mm concrete nails or 6mm x 40mm concrete anchors.
- A 5mm gap between GIB® Rondo® 140 Perimeter Channels will let any collected rain water escape.
- GIB® Rondo® 140 Perimeter Channel to be sealed to the floor slab on one side with fire/acoustic sealant.
- Install 25mm GIB Barrierline® into GIB® H-Studs at 600mm centres.
- Cap GIB Barrierline® ends with GIB® Rondo® 140 Perimeter Channel.
- Offset GIB® H-Studs at least 100mm from wall studs to allow attachment of GIB® Wall Clips to both frames. Nog as required where no framing exists.
- Place two GIB® Wall Clips (one each side) no more than 600mm below the top of each GIB® H-Stud, no further apart than 3000mm vertically.
- Fix GIB® Rondo® 140 Perimeter Channel at wall ends to both timber frames with GIB® Wall Clips or GIB® Wall Straps placed no further apart than 3000mm vertically.
- Use no more than two GIB® Wall Clips or GIB® Wall Straps (one each side) for each 3000mm length of GIB® H-Stud or GIB® Rondo® 140 Perimeter Channel.
- In the roof space, fix 16mm GIB Fyreline® to one side of the GIB Barrierline® with 40mm x 8g chipboard screws on a 400mm grid, and at no more than 100mm from sheet edges.
- Extend the 16mm GIB Fyreline® at least 200mm below ceiling level.
- Once erected, protect the GIB Barrierline® and GIB Fyreline® from rain. The use of suitable sheeting can avoid delays in allowing the board to dry before wall linings are installed.

SOUND CONTROL INFILL

Install Pink® Batts® R2.2 (90mm) glass wool insulation between the studs and nogs in both frames.

WALL LINING

A single layer of 13mm GIB® Standard Plasterboard fixed vertically or horizontally.

Use full height sheets where possible.

Sheet joints are touch fitted and must occur over framing.

Where sheet end butt joints are unavoidable they must be formed over framing.

If the wall lining forms part of the structural bracing system, the lining type and fixings must comply with the published bracing system. Check requirements for specific bracing element hold-down connections.

FASTENING THE LINING

Fasteners

32mm x 6g GIB® Grabber® High Thread Drywall Screws.

Fastener centres

300mm centres to each stud and plate. Place screws no closer than 12mm from paperbound edges and 18mm from any sheet end or cut edges.

BUILDING SERVICE PENETRATIONS

Plumbing and electrical services are permitted in the cavities either side of the central barrier. Back-to-back services and penetrations are permitted within the limitations given below. A minimum of 10mm clearance must be provided between plumbing or electrical services and the central barrier.

Metal and PVC plumbing services up to 65mm diameter do not need specialist fire-stopping where they penetrate the wall linings. Penetrations through wall linings must have neatly cut holes with 6mm maximum clearance around the plumbing service. Fill the gap with general purpose flexible sealant.

Electrical services up to 90 x 50mm that penetrate wall linings do not need to be fire-stopped. Limit flush boxes to two per nominally 600mm wide stud bay.

Suitable proprietary fire-stopping is required for larger penetrations, and for penetrations through the GIB Barrierline® central barrier. Penetrating the GIB Barrierline® central barrier may reduce the noise control performance of the system.

Two way FRR – double timber frame with GIB Barrierline® central barrier

Specification number	Performance	Specifications
GBTLAB 60d	STC 61	Lining 1 x 13mm GIB® Standard Plasterboard each side
	Rw 60	LB/NLB Load bearing
	FRR 60/60/60	Partition 286–316mm wide

WET AREA WALL LINING

If the 13mm GIB® Standard Plasterboard wall lining is substituted with 13mm GIB Aqualine®, the FRR and noise control rating will be retained.

JOINTING

Central Barrier: Unstopped.

Wall lining: All fastener heads stopped and all sheet joints tape reinforced and stopped in accordance with the publication entitled “GIB® Site Guide”. Wall to ceiling junctions are to be reinforced with paper tape and square stopped or finished with GIB-Cove®.

SUPPLEMENTARY MATERIAL

For additional information on this system refer to the GIB® Intertency Barrier Systems for Terrace Homes Specification and Installation Manual.

Place two GIB® Wall Clips (one each side) no more than 600mm below the top of each GIB® H-Stud, no further apart than 3000mm vertically
13mm GIB® Standard Plasterboard

Pink® Batts®
R2.2 (90mm) glass wool insulation

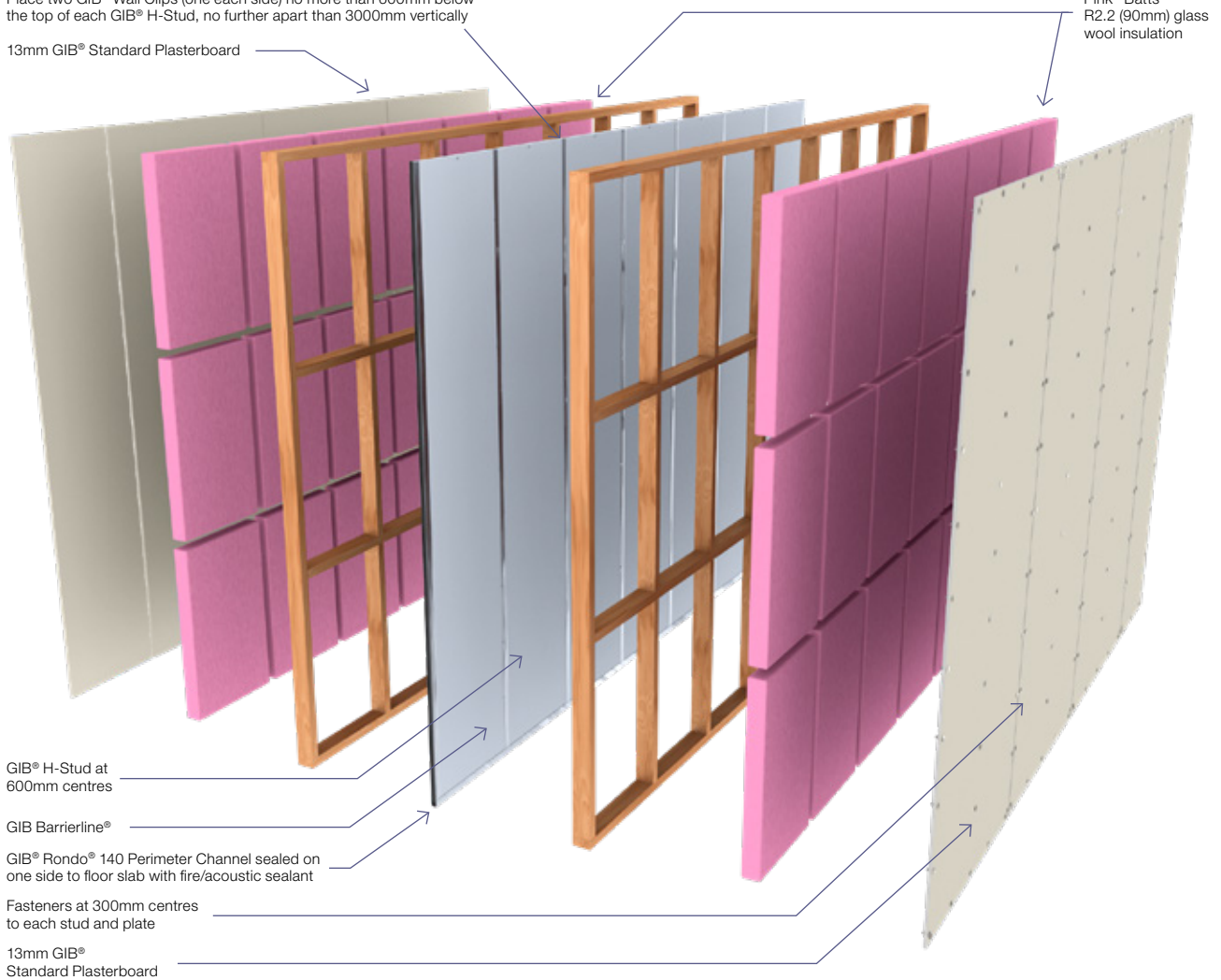

GIB® H-Stud at 600mm centres

GIB Barrierline®

GIB® Rondo® 140 Perimeter Channel sealed on one side to floor slab with fire/acoustic sealant

Fasteners at 300mm centres to each stud and plate

13mm GIB® Standard Plasterboard

Two way FRR — double steel frame with GIB Barrierline® central barrier

Specification number	Performance	Specifications
GBSAB 60a	STC 63 Rw 63 FRR -/60/60	Lining 1 x 13mm GIB® Standard Plasterboard each side LB/NLB Non load bearing Partition 219mm wide

FRAMING

Steel stud dimensions 64 x 34 x 0.50mm BMT with 6mm return and placed in 64 x 30 x 0.50mm BMT steel channel. Channel is fixed to floor and ceiling. Studs are friction fitted at 600mm centres maximum with 15mm expansion gap at the top of the frame. No fixings to the top channel.

Allow a minimum 20mm gap between the inside of each steel wall frame and the GIB Barrierline®.

WALL HEIGHTS

Recommended maximum wall height is 2700mm. For greater wall heights refer to the steel stud centres and wall heights section on pages 14–15 of this publication.

For wall heights greater than 3000mm a horizontal joint will need to be formed in the central barrier. Refer to page 102 for more information.

CENTRAL BARRIER

- Fix GIB® Rondo® 140 Perimeter Channel to floor slab with steel fasteners at 150mm maximum from ends and 600mm maximum centres in between and seal one side with fire/acoustic sealant.
- Fix GIB® Rondo® NZ18 Perimeter Angles or GIBFix® Angles to the slab above along one wall face using steel fasteners at 150mm maximum from ends and 600mm maximum centres in between.
- Cap GIB Barrierline® end with GIB® Rondo® 140 Perimeter Channel and seal one side with fire/acoustic sealant.
- Install GIB Barrierline® in GIB® H-Studs placed at 600mm centres.
- Close the top of the wall and the final panel using GIB® Rondo® NZ18 Perimeter Angles or GIBFix® Angles sealed to GIB Barrierline® one side with fire/acoustic sealant, and fasten as above.

SOUND CONTROL INFILL

Pink® Batts® BIB R1.8 (75mm) glass wool insulation installed between the studs in both frames.

WALL LINING

A single layer of 13mm GIB® Standard Plasterboard fixed vertically to each side of the frames. Sheets fitted hard to floor. Use full height sheets where possible. Sheet joints are touch fitted and must occur over framing.

ACOUSTIC SEALANT

A bead of GIB Soundseal® acoustic sealant is required around the perimeter of the wall lining.

FASTENING THE LINING

Fasteners

25mm x 6g GIB® Grabber® Self Tapping Drywall Screws.

Fastener centres

300mm centres up each stud. Place fasteners 12mm from sheet edges generally and 20mm clear of top and bottom channels.

BUILDING SERVICE PENETRATIONS

Plumbing and electrical services are permitted in the cavities either side of the central barrier. Back-to-back services and penetrations are permitted within the limitations given below. A minimum of 10mm clearance must be provided between plumbing or electrical services and the central barrier.

Metal and PVC plumbing services up to 65mm diameter do not need specialist fire-stopping where they penetrate the wall linings. Penetrations through wall linings must have neatly cut holes with 6mm maximum clearance around the plumbing service. Fill the gap with general purpose flexible sealant.

Electrical services up to 90 x 50mm that penetrate wall linings do not need to be fire-stopped. Limit flush boxes to two per nominally 600mm wide stud bay.

Suitable proprietary fire-stopping is required for larger penetrations, and for penetrations through the GIB Barrierline® central barrier. Penetrating the GIB Barrierline® central barrier may reduce the noise control performance of the system.

WET AREA WALL LINING

If the 13mm GIB® Standard Plasterboard wall lining is substituted with 13mm GIB Aqualine®, the FRR and noise control rating will be retained.

JOINTING

Central barrier: Unstopped.

Wall lining: All fastener heads stopped and all sheet joints tape reinforced and stopped in accordance with the publication entitled GIB® Site Guide. Wall to ceiling junctions are to be reinforced with paper tape and square stopped or finished with GIB-Cove®.

Two way FRR — double steel frame with GIB Barrierline® central barrier

Specification number	Performance	Specifications
GBSAB 60a	STC 63	Lining 1 x 13mm GIB® Standard Plasterboard each side
	Rw 63	LB/NLB Non load bearing
	FRR -/60/60	Partition 219mm wide

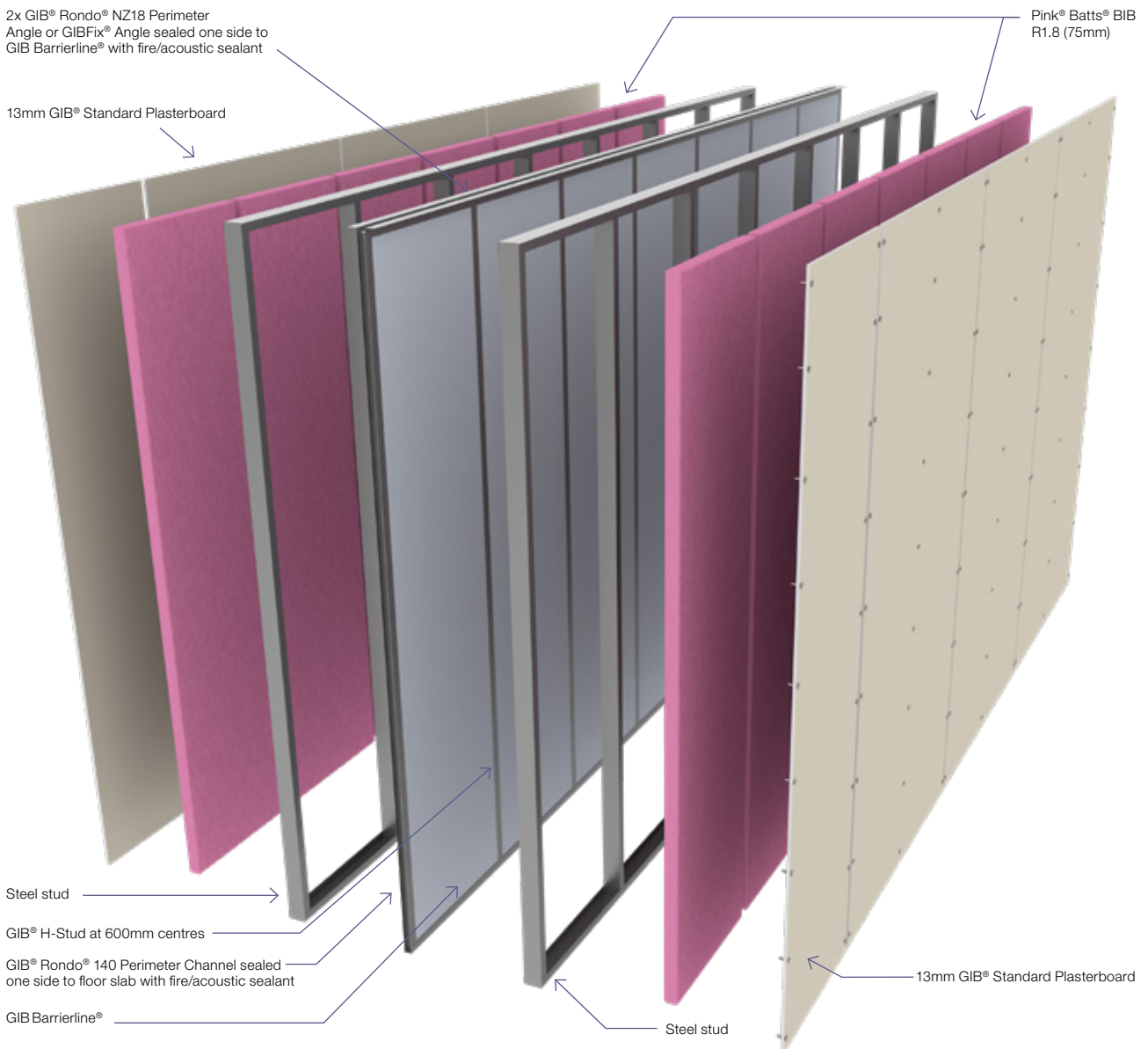

Two way FRR — double steel frame with GIB Barrierline® central barrier

Specification number	Performance	Specifications
GBSAB 60b	STC 67 Rw 66 FRR -/60/60	Lining 2 x 13mm GIB® Standard Plasterboard one side 1 x 13mm GIB® Standard Plasterboard other side LB/NLB Non load bearing Partition 232mm wide

FRAMING

Steel stud dimensions 64 x 34 x 0.50mm BMT with 6mm return and placed in 64 x 30 x 0.50mm BMT steel channel. Channel is fixed to floor and ceiling. Studs are friction fitted at 600mm centres maximum with 15mm expansion gap at the top of the frame. No fixings to the top channel.

Allow a minimum of 20mm gap between the inside of each steel wall frame and the GIB Barrierline®.

WALL HEIGHTS

Recommended maximum wall height is 2700mm. For greater wall heights refer to the steel stud centres and wall heights section on pages 14–15 of this publication.

For wall heights greater than 3000mm a horizontal joint will need to be formed in the central barrier. Refer to page 102 for more information.

CENTRAL BARRIER

- Fix GIB® Rondo® 140 Perimeter Channel to floor slab with steel fasteners at 150mm maximum from ends and 600mm maximum centres in between and seal one side with fire/acoustic sealant.
- Fix GIB® Rondo® NZ18 Perimeter Angles or GIBFix® Angles to the slab above along one wall face using steel fasteners at 150mm maximum from ends and 600mm maximum centres in between.
- Cap GIB Barrierline® end with GIB® Rondo® 140 Perimeter Channel and seal one side with fire/acoustic sealant.
- Install GIB Barrierline® in GIB® H-Studs placed at 600mm centres.
- Close the top of the wall and the final panel using GIB® Rondo® NZ18 Perimeter Angles or GIBFix® Angles sealed to GIB Barrierline® one side with fire/acoustic sealant, and fasten as above.

SOUND CONTROL INFILL

Pink® Batts® BIB R1.8 (75mm) glass wool insulation installed between the studs in both frames.

WALL LINING

1 layer of 13mm GIB® Standard Plasterboard fixed vertically one side of the frame and 2 layers of 13mm GIB® Standard Plasterboard fixed vertically on the other. Vertical joints of the outer layer are offset 600mm from those of the inner layer. Sheets fitted hard to floor. Use full height sheets where possible. Sheet joints are touch fitted and must occur over framing.

ACOUSTIC SEALANT

A bead of GIB Soundseal® acoustic sealant is required around the perimeter of the inner lining. The outer lining is then bedded onto the bead.

FASTENING THE LINING

Fasteners

Inner layer and single layer: 25mm x 6g GIB® Grabber® Self Tapping Drywall Screws.

Outer layer: 41mm x 6g GIB® Grabber® Self Tapping Drywall Screws

Fastener centres

Inner layer and single layer: 300mm centres up each stud. Place fasteners 12mm from sheet edges generally and 20mm clear of top and bottom channels.

Outer layer: 300mm centres up each stud. Place fasteners 12mm from sheet edges generally and 30mm clear of top and bottom channels.

GIBFix® adhesive may be used to replace screws in the field of outer layer sheets. Do not replace screws with GIBFix® adhesive at sheet edges or place adhesive within 200mm of screw fixings.

BUILDING SERVICE PENETRATIONS

Plumbing and electrical services are permitted in the cavities either side of the central barrier. Back-to-back services and penetrations are permitted within the limitations given below. A minimum of 10mm clearance must be provided between plumbing or electrical services and the central barrier.

Metal and PVC plumbing services up to 65mm diameter do not need specialist fire-stopping where they penetrate the wall linings. Penetrations through wall linings must have neatly cut holes with 6mm maximum clearance around the plumbing service. Fill the gap with general purpose flexible sealant.

Electrical services up to 90 x 50mm that penetrate wall linings do not need to be fire-stopped. Limit flush boxes to two per nominally 600mm wide stud bay.

Suitable proprietary fire-stopping is required for larger penetrations, and for penetrations through the GIB Barrierline® central barrier. Penetrating the GIB Barrierline® central barrier may reduce the noise control performance of the system.

WET AREA WALL LINING

If the 13mm GIB® Standard Plasterboard wall lining is substituted with 13mm GIB Aqualine®, the FRR and noise control rating will be retained.

JOINTING

Central barrier: Unstopped.

Inner layer: Unstopped.

Outer layer: All fastener heads stopped and all sheet joints tape reinforced and stopped in accordance with the publication entitled GIB® Site Guide. Wall to ceiling junctions to be reinforced with paper tape and square stopped or finished with GIB-Cove®.

Two way FRR — double steel frame with GIB Barrierline® central barrier

Specification number	Performance	Specifications
GBSAB 60b	STC 67	Lining 2 x 13mm GIB® Standard Plasterboard one side 1 x 13mm GIB® Standard Plasterboard other side
	Rw 66	
	FRR -/60/60	LB/NLB Non load bearing Partition 232mm wide

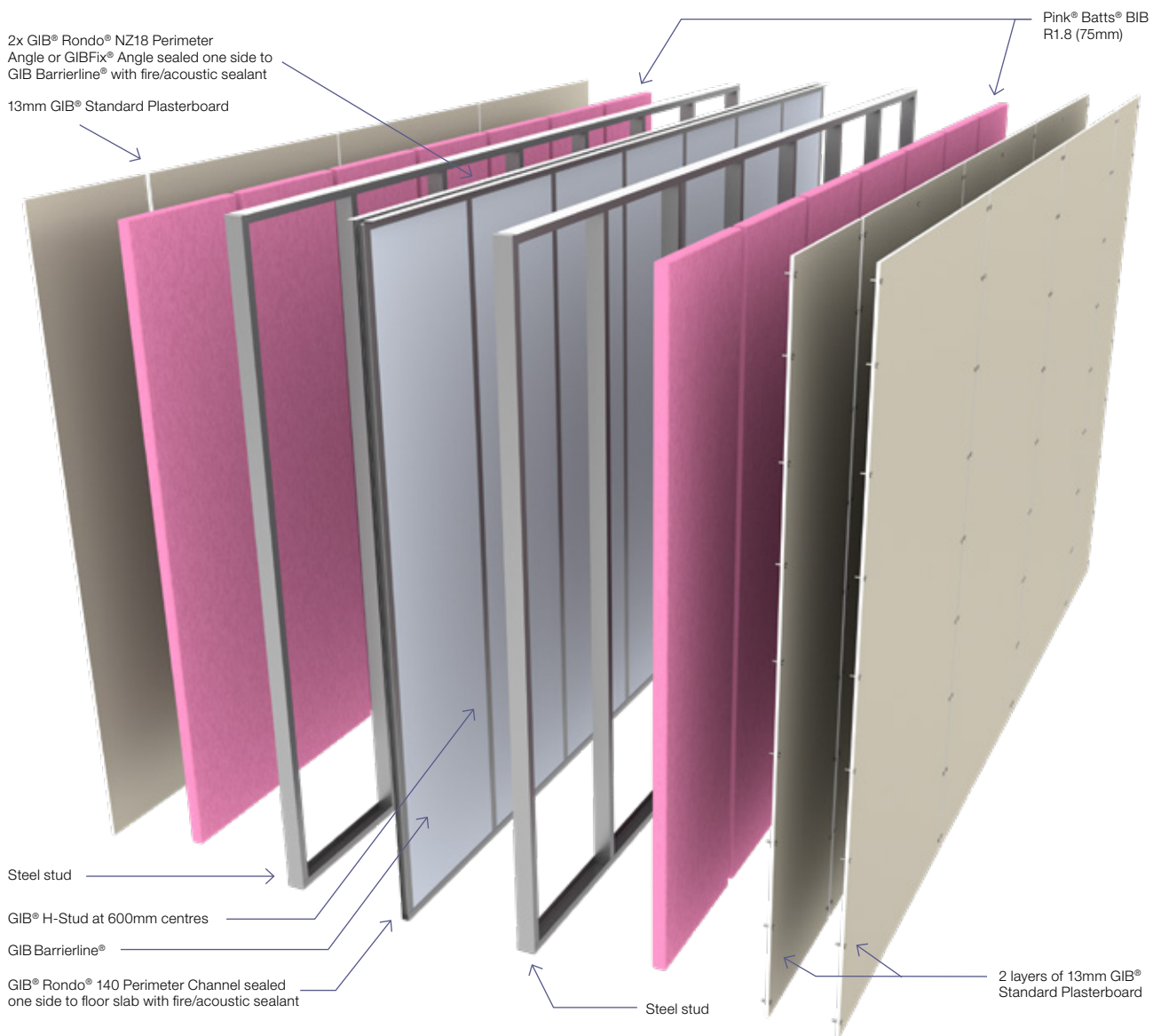

Two way FRR — double steel frame with GIB Barrierline® central barrier

Specification number	Performance	Specifications
GBSAB 60c	STC 68 Rw 66 FRR -/60/60	Lining 1 x 13mm GIB Braceline®/GIB Noiseline® each side LB/NLB Non load bearing Partition 219mm wide

FRAMING

Steel stud dimensions 64 x 34 x 0.50mm BMT with 6mm return and placed in 64 x 30 x 0.50mm BMT steel channel. Channel is fixed to floor and ceiling. Studs are friction fitted at 600mm centres maximum with 15mm expansion gap at the top of the frame. No fixings to the top channel.

Allow a minimum of 20mm gap between the inside of each steel wall frame and the GIB Barrierline®.

WALL HEIGHTS

Recommended maximum wall height is 2700mm. For greater wall heights refer to the steel stud centres and wall heights section on pages 14–15 of this publication.

For wall heights greater than 3000mm a horizontal joint will need to be formed in the central barrier. Refer to page 102 for more information.

CENTRAL BARRIER

- Fix GIB® Rondo® 140 Perimeter Channel to floor slab with steel fasteners at 150mm maximum from ends and 600mm maximum centres in between and seal one side with fire/acoustic sealant.
- Fix GIB® Rondo® NZ18 Perimeter Angles or GIBFix® Angles to the slab above along one wall face using steel fasteners at 150mm maximum from ends and 600mm maximum centres in between.
- Cap GIB Barrierline® end with GIB® Rondo® 140 Perimeter Channel and seal one side with fire/acoustic sealant.
- Install GIB Barrierline® in GIB® H-Studs placed at 600mm centres.
- Close the top of the wall and the final panel using GIB® Rondo® NZ18 Perimeter Angles or GIBFix® Angles sealed to GIB Barrierline® one side with fire/acoustic sealant, and fasten as above.

SOUND CONTROL INFILL

Pink® Batts® BIB R1.8 (75mm) glass wool insulation installed between the studs in both frames.

WALL LINING

1 layer of 13mm GIB Braceline®/GIB Noiseline® fixed vertically to each side of the frames. Sheets fitted hard to floor. Use full height sheets where possible. Sheet joints are touch fitted and must occur over framing.

ACOUSTIC SEALANT

A bead of GIB Soundseal® acoustic sealant is required around the perimeter of the wall lining.

FASTENING THE LINING

Fasteners

25mm x 6g GIB® Grabber® Self Tapping Drywall Screws.

Fastener centres

300mm centres up each stud. Place fasteners 12mm from sheet edges generally and 20mm clear of top and bottom channels.

BUILDING SERVICE PENETRATIONS

Plumbing and electrical services are permitted in the cavities either side of the central barrier. Back-to-back services and penetrations are permitted within the limitations given below. A minimum of 10mm clearance must be provided between plumbing or electrical services and the central barrier.

Metal and PVC plumbing services up to 65mm diameter do not need specialist fire-stopping where they penetrate the wall linings. Penetrations through wall linings must have neatly cut holes with 6mm maximum clearance around the plumbing service. Fill the gap with general purpose flexible sealant.

Electrical services up to 90 x 50mm that penetrate wall linings do not need to be fire-stopped. Limit flush boxes to two per nominally 600mm wide stud bay.

Suitable proprietary fire-stopping is required for larger penetrations, and for penetrations through the GIB Barrierline® central barrier. Penetrating the GIB Barrierline® central barrier may reduce the noise control performance of the system.

WET AREA WALL LINING

If the 13mm GIB Braceline®/GIB Noiseline® wall lining is substituted with 13mm GIB Aqualine®, the FRR will be retained but a noise control reduction of up to 3 STC/Rw points can be expected.

JOINTING

Central barrier: Unstopped.

Wall lining: All fastener heads stopped and all sheet joints tape reinforced and stopped in accordance with the publication entitled GIB® Site Guide. Wall to ceiling junctions are to be reinforced with paper tape and square stopped or finished with GIB-Cove®.

Two way FRR — double steel frame with GIB Barrierline® central barrier

Specification number	Performance	Specifications
GBSAB 60c	STC 68 Rw 66 FRR -/60/60	Lining 1 x 13mm GIB Braceline®/GIB Noiseline® each side LB/NLB Non load bearing Partition 219mm wide

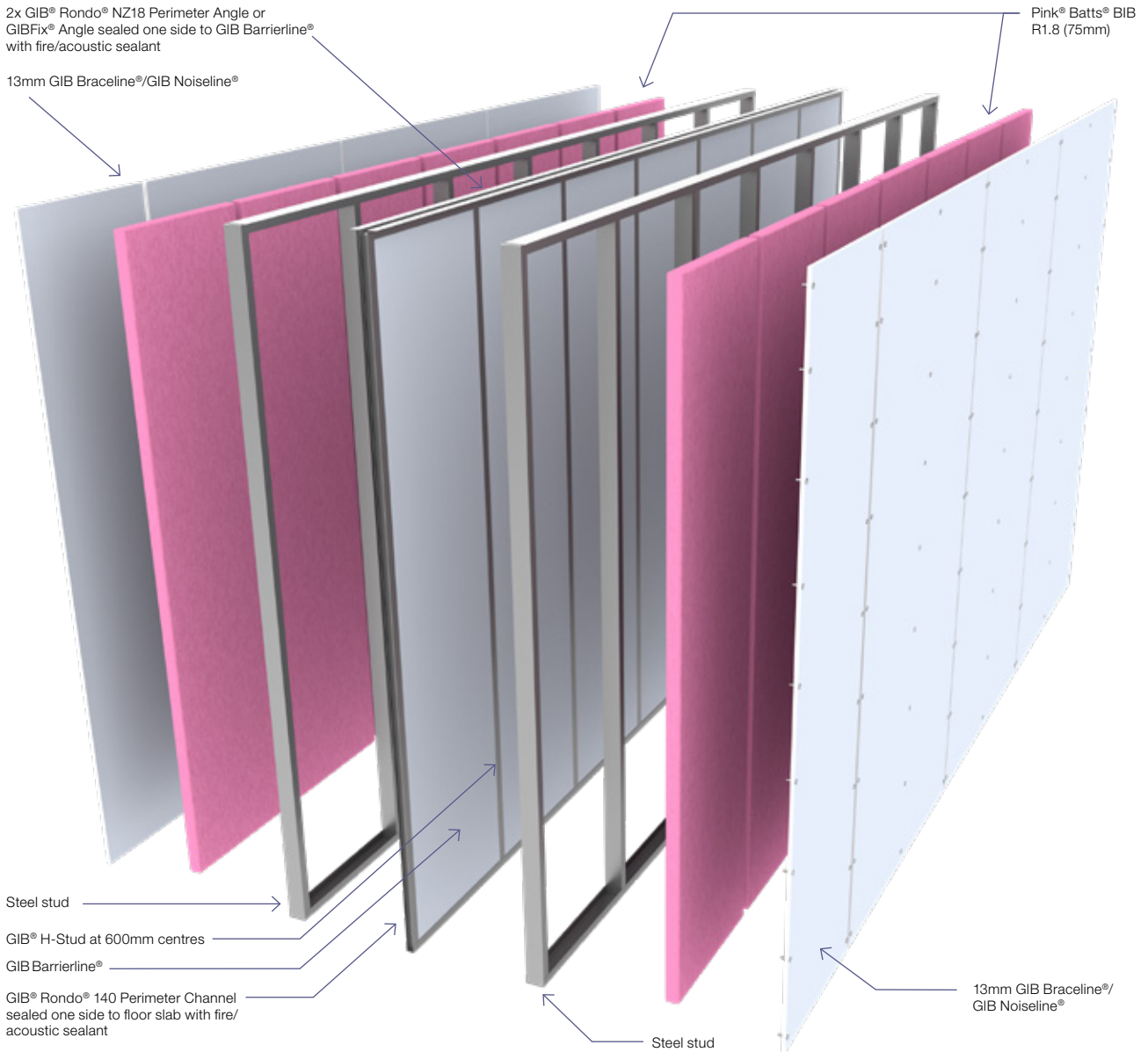

Two way FRR — staggered stud steel frame, 13mm GIB Fyreline® central barrier

Specification number	Performance	Specifications
GBSAB 60d	STC 56 Rw 56 FRR -/60/60	Lining 1 x 13mm GIB Fyreline® and 1 x 10mm GIB® Standard Plasterboard each side LB/NLB Non load bearing Partition 187mm wide

FRAMING

Steel stud dimensions 64 x 34 x 0.50mm BMT with 6mm return and placed in 64 x 30 x 0.50mm BMT steel channel. Channel is fixed to floor and ceiling. Studs are friction fitted at 600mm centres maximum with 15mm expansion gap at the top of the frame. No fixings to the top channel.

WALL HEIGHTS

Recommended maximum wall height is 4000mm. Specify 50mm deep deflection head channel at top of wall and 20mm expansion tolerance at top of studs for wall heights over 3400mm.

CENTRAL BARRIER

- Fix top and bottom channels for the first frame to slabs with steel fasteners at 150mm maximum from ends and 600mm maximum centres in between and install steel studs at 600mm centres.
- Fix 13mm GIB Fyreline® central barrier vertically to one side with 25mm x 6g GIB® Grabber® Self Tapping Drywall Screws at 300mm centres. Place fasteners 12mm from sheet edges and 20mm clear of top and bottom channels. All sheet joints over framing.
- Construct a second frame against the central barrier. Fix tracks to slabs as above and place studs at 600mm centres, offset from first frame studs by 300mm.
- Fix the 13mm GIB Fyreline® central barrier to the studs of the second frame with 25mm x 6g GIB® Grabber® Self Tapping Drywall Screws at 300mm centres. Place fasteners 12mm from sheet edges and 20mm clear of top and bottom channels. All sheet joints over framing.

SOUND CONTROL INFILL

Pink® Batts® R1.2 (50mm) glass wool insulation installed between the studs in both frames.

WALL LINING

Inner layer: 13mm GIB Fyreline® fixed vertically to each open side of the double frame. Sheets fitted hard to floor. Use full height sheets where possible. Sheet joints are touch fitted and must occur over framing.

Outer layer: 10mm GIB® Standard Plasterboard fixed horizontally or vertically. If fixed vertically the joints of the outer layer must be offset by 600mm from the inner layer.

ACOUSTIC SEALANT

A bead of GIB Soundseal® acoustic sealant is required around the perimeter of the inner lining. The outer lining is then bedded onto the bead.

FASTENING THE LINING

Fasteners

Inner layer: 25mm x 6g GIB® Grabber® Self Tapping Drywall Screws.

Outer layer: 41mm x 6g GIB® Grabber® Self Tapping Drywall Screws.

Fastener centres

Fix inner layer sheets at 300mm centres to all studs and 20mm clear of top and bottom channels. When fixing outer layer sheets vertically, offset sheet joints from the inner layer. Fix at 300mm centres to all studs with top and bottom fasteners placed 30mm clear of top and bottom channels.

When fixing outer layer sheets horizontally, install fasteners in the sheet tapers where they cross the studs, and at 300mm centres to all studs with top and bottom fasteners placed 30mm clear of the top and bottom channels.

GIBFix® adhesive may be used to replace screws in the field of outer layer sheets. Do not replace screws with GIBFix® adhesive at sheet edges or place adhesive within 200mm of screw fixings.

BUILDING SERVICE PENETRATIONS

Plumbing and electrical services are permitted in the cavities either side of the central barrier. Back-to-back services and penetrations are permitted within the limitations given below. A minimum of 10mm clearance must be provided between plumbing or electrical services and the central barrier.

Metal and PVC plumbing services up to 65mm diameter do not need specialist fire-stopping where they penetrate the wall linings. Penetrations through wall linings must have neatly cut holes with 6mm maximum clearance around the plumbing service. Fill the gap with general purpose flexible sealant.

Electrical services up to 90 x 50mm that penetrate wall linings do not need to be fire-stopped. Limit flush boxes to two per nominally 600mm wide stud bay.

Suitable proprietary fire-stopping is required for larger penetrations, and for penetrations through the 13mm GIB Fyreline® central barrier. Penetrating the 13mm GIB Fyreline® central barrier may reduce the noise control performance of the system.

WET AREA WALL LINING

If the outer layer of 10mm GIB® Standard Plasterboard wall lining is substituted with 10mm GIB Aqualine®, the FRR and noise control rating will be retained.

JOINTING

Central barrier: Unstopped.

Inner layer: Unstopped.

Outer layer: All fastener heads stopped and all sheet joints tape reinforced and stopped in accordance with the publication entitled GIB® Site Guide. Wall to ceiling junctions are to be reinforced with paper tape and square stopped or finished with GIB-Cove®.

Two way FRR — staggered stud steel frame, 13mm GIB Fyreline® central barrier

Specification number	Performance	Specifications
GBSAB 60d	STC 56 Rw 56 FRR -/60/60	Lining 1 x 13mm GIB Fyreline® and 1 x 10mm GIB® Standard Plasterboard each side LB/NLB Non load bearing Partition 187mm wide

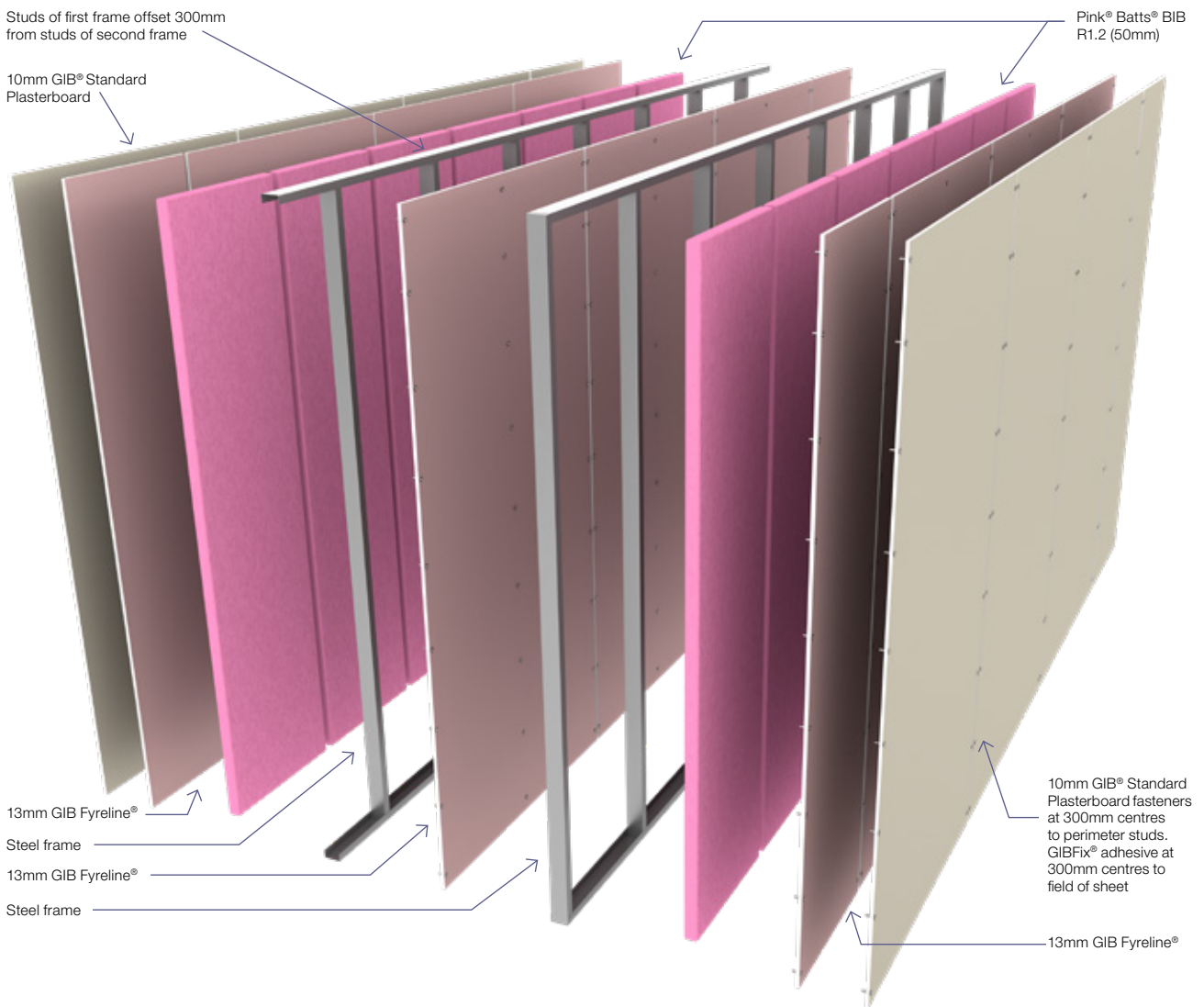

CONSTRUCTION SEQUENCE

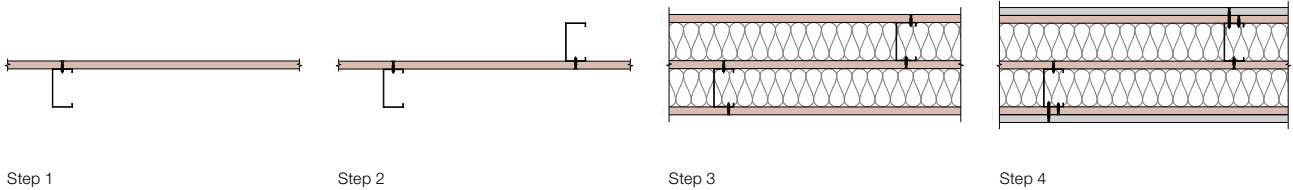

GNS001

Two way FRR — staggered stud steel frame, 13mm GIB Fyreline® central barrier

Specification number	Performance	Specifications
GBSAB 60e	STC 57 Rw 58 FRR -/60/60	Lining 1 x 13mm GIB Fyreline® and 1 x 13mm GIB® Standard Plasterboard each side LB/NLB Non load bearing Partition 193mm wide

FRAMING

Steel stud dimensions 64 x 34 x 0.50mm BMT with 6mm return and placed in 64 x 30 x 0.50mm BMT steel channel. Channel is fixed to floor and ceiling. Studs are friction fitted at 600mm centres maximum with 15mm expansion gap at the top of the frame. No fixings to the top channel.

WALL HEIGHTS

Recommended maximum wall height is 4000mm. Specify 50mm deep deflection head channel at top of wall and 20mm expansion tolerance at top of studs or wall heights over 3400mm.

CENTRAL BARRIER

- Fix top and bottom channels for the first frame to slabs with steel fasteners at 150mm maximum from ends and 600mm maximum centres in between and install steel studs at 600mm centres.
- Fix 13mm GIB Fyreline® central barrier vertically to one side with 25mm x 6g GIB® Grabber® Self Tapping Drywall Screws at 300mm centres. Place fasteners 12mm from sheet edges and 20mm clear of top and bottom channels. All sheet joints over framing.
- Construct a second frame against the central barrier. Fix tracks to slabs as above and place studs at 600mm centres, offset from first frame studs by 300mm.
- Fix the 13mm GIB Fyreline® central barrier to the studs of the second frame with 25mm x 6g GIB® Grabber® Self Tapping Drywall Screws at 300mm centres. Place fasteners 12mm from sheet edges and 20mm clear of top and bottom channels. All sheet joints over framing.

SOUND CONTROL INFILL

Pink® Batts® R1.2 (50mm) glass wool insulation installed between the studs in both frames.

WALL LINING

Inner layer: 13mm GIB Fyreline® fixed vertically to each open side of the double frame. Sheets fitted hard to floor. Use full height sheets where possible. Sheet joints are touch fitted and must occur over framing.

Outer layer: 13mm GIB® Standard Plasterboard fixed horizontally or vertically. If fixed vertically the joints of the outer layer must be offset by 600mm from the inner layer.

ACOUSTIC SEALANT

A bead of GIB Soundseal® acoustic sealant is required around the perimeter of the inner lining. The outer lining is then bedded onto the bead.

FASTENING THE LINING

Fasteners

Inner layer: 25mm x 6g GIB® Grabber® Self Tapping Drywall Screws.

Outer layer: 41mm x 6g GIB® Grabber® Self Tapping Drywall Screws.

Fastener centres

Fix inner layer sheets at 300mm centres to all studs and 20mm clear of top and bottom channels. When fixing outer layer sheets vertically, offset sheet joints from the inner layer. Fix at 300mm centres to all studs with top and bottom fasteners placed 30mm clear of top and bottom channels.

When fixing outer layer sheets horizontally, install fasteners in the sheet tapers where they cross the studs, and at 300mm centres to all studs with top and bottom fasteners placed 30mm clear of the top and bottom channels.

GIBFix® adhesive may be used to replace screws in the field of outer layer sheets. Do not replace screws with GIBFix® adhesive at sheet edges or place adhesive within 200mm of screw fixings.

BUILDING SERVICE PENETRATIONS

Plumbing and electrical services are permitted in the cavities either side of the central barrier. Back-to-back services and penetrations are permitted within the limitations given below. A minimum of 10mm clearance must be provided between plumbing or electrical services and the central barrier.

Metal and PVC plumbing services up to 65mm diameter do not need specialist fire-stopping where they penetrate the wall linings. Penetrations through wall linings must have neatly cut holes with 6mm maximum clearance around the plumbing service. Fill the gap with general purpose flexible sealant.

Electrical services up to 90 x 50mm that penetrate wall linings do not need to be fire-stopped. Limit flush boxes to two per nominally 600mm wide stud bay.

Suitable proprietary fire-stopping is required for larger penetrations, and for penetrations through the 13mm GIB Fyreline® central barrier. Penetrating the 13mm GIB Fyreline® central barrier may reduce the noise control performance of the system.

WET AREA WALL LINING

If the 13mm GIB® Standard Plasterboard wall lining is substituted with 13mm GIB Aqualine®, the FRR and noise control rating will be retained.

JOINTING

Central barrier: Unstopped.

Inner layer: Unstopped.

Outer layer: All fastener heads stopped and all sheet joints tape reinforced and stopped in accordance with the publication entitled GIB® Site Guide. Wall to ceiling junctions are to be reinforced with paper tape and square stopped or finished with GIB-Cove®.

Two way FRR — staggered stud steel frame, 13mm GIB Fyreline® central barrier

Specification number	Performance	Specifications
GBSAB 60e	STC 57 Rw 58 FRR -/60/60	Lining 1 x 13mm GIB Fyreline® and 1 x 13mm GIB® Standard Plasterboard each side LB/NLB Non load bearing Partition 193mm wide

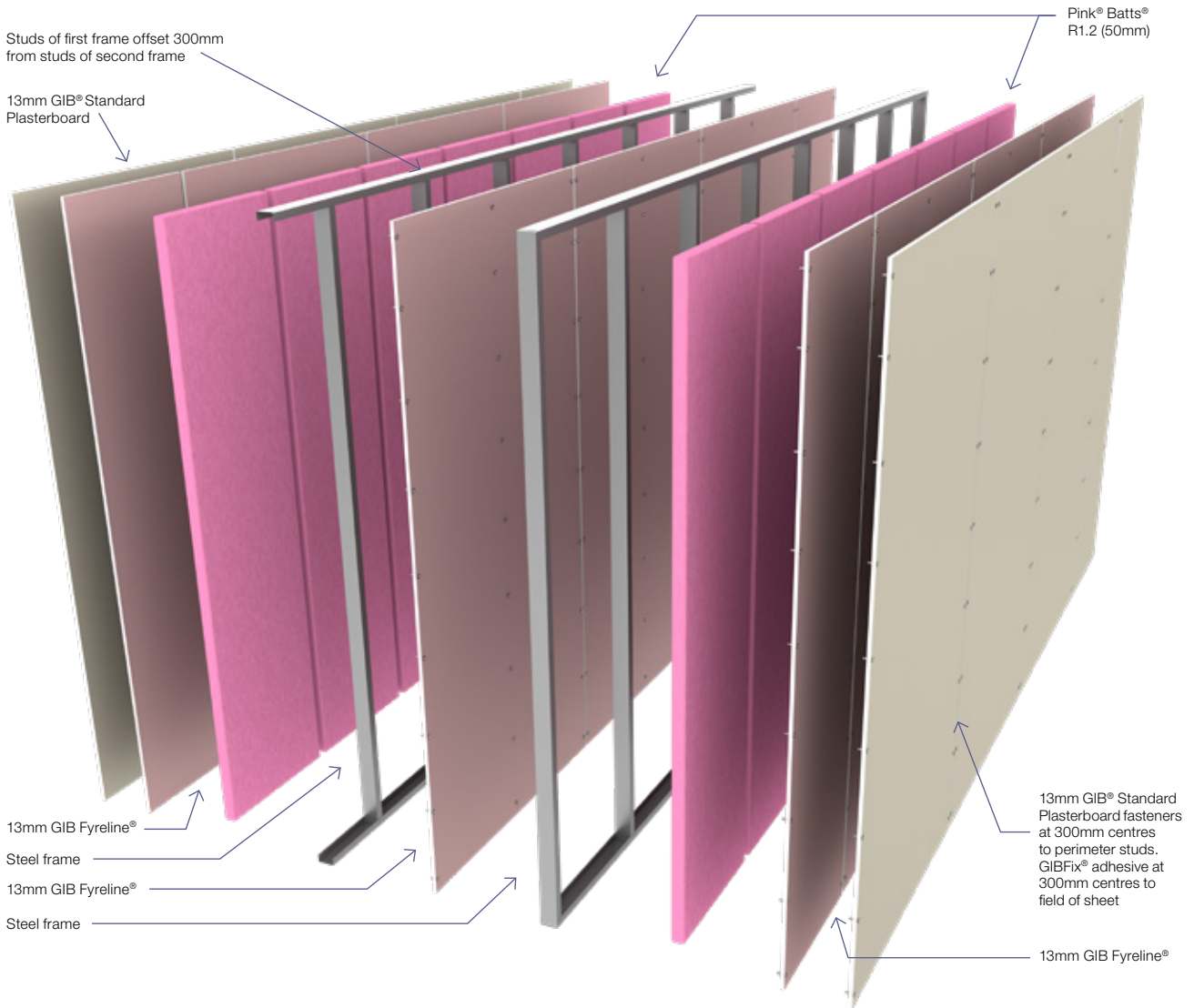

CONSTRUCTION SEQUENCE

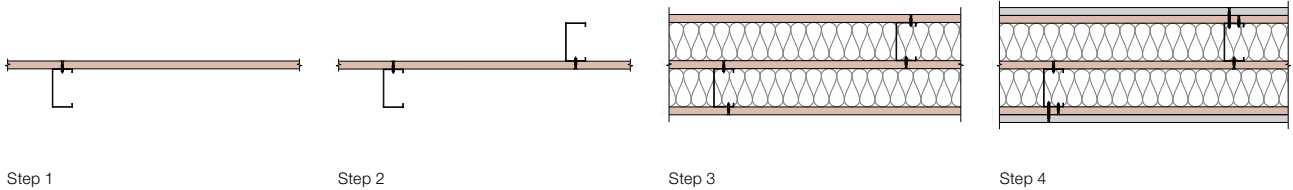

GNS001

Two way FRR — double timber frame wall

Specification number	Performance	Specifications
GBTLA 30a	STC 58	Lining 2 x 10mm GIB® Standard Plasterboard each side
	Rw 57	LB/NLB Load bearing
	FRR 30/30/30	Partition 245mm wide

FRAMING

Stud size	Space between frames
70mm	65mm min
90mm	25mm min

Framing to comply with:

- NZBC B1 — Structure: AS1 Clause 3 — Timber (NZS 3604) or VM1 Clause 6 — Timber (NZS 3603).
- NZBC B2 — Durability: AS1 Clause 3.2 — Timber (NZS 3602).
- Studs at 600mm centres maximum.
- Nogs at 1350mm centres maximum.

Framing dimensions and height as determined by NZS 3604 stud and top plate tables for load-bearing walls.

SOUND CONTROL INFILL

Pink® Batts® R2.2 (90mm) glass wool insulation installed between the studs and nogs on one side of the double frame.

WALL LINING

2 layers of 10mm GIB® Standard Plasterboard fixed vertically each side of the frame.

Vertical joints of the outer layer are offset 600mm from those of the inner layer. Use full height sheets where possible. Sheet joints are touch fitted and must occur over framing. Where sheet end joints are unavoidable they must be over nogs and outer layer joints offset from those on the inner layer.

ACOUSTIC SEALANT

A bead of GIB Soundseal® acoustic sealant is required around the perimeter of the inner lining. The outer lining is then bedded onto the bead.

FASTENING THE LINING

Fasteners

Inner layer: 25mm x 6g GIB® Grabber® High Thread Drywall Screws.

Outer layer: 41mm x 6g GIB® Grabber® High Thread Drywall Screws.

Fastener centres

Inner layer and outer layer: 300mm centres around sheet perimeter and 300mm to intermediate studs. Place fasteners 12mm from sheet edges.

JOINTING

Inner layer: Unstopped.

Outer layer: All fastener heads stopped and all sheet joints tape reinforced and stopped in accordance with the publication entitled GIB® Site Guide. Wall to ceiling junctions are to be reinforced with paper tape and square stopped or finished with GIB-Cove®.

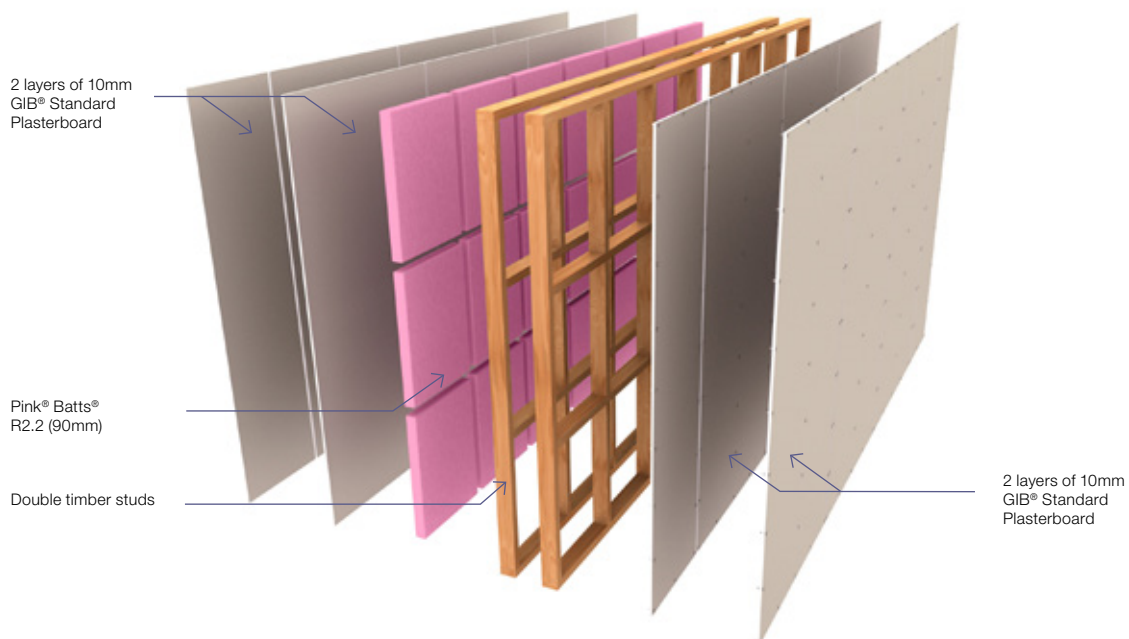

Two way FRR — double timber frame wall

Specification number	Performance	Specifications
GBTLA 30b	STC 58	Lining Side 1: 1 x 10mm GIB Braceline®/GIB Noiseline® Side 2: 2 x 10mm GIB Braceline®/GIB Noiseline®
	Rw 57	
	FRR 30/30/30	LB/NLB Load bearing Partition 235mm wide

FRAMING

Stud size	Space between frames
70mm	65mm min
90mm	25mm min

Framing to comply with:

- NZBC B1 — Structure: AS1 Clause 3 — Timber (NZS 3604) or VM1 Clause 6 — Timber (NZS 3603).
- NZBC B2 — Durability: AS1 Clause 3.2 — Timber (NZ 3602).
- Studs at 600mm centres maximum.
- Nogs at 1350mm centres maximum.

Framing dimensions and height as determined by NZS 3604 stud and top plate tables for load-bearing walls.

SOUND CONTROL INFILL

Pink® Batts® R2.2 (90mm) glass wool insulation installed between the studs and nogs on one side of the double frame.

WALL LINING

Side 1: 1 layer of 10mm GIB Braceline®/GIB Noiseline® fixed vertically.

Side 2: 2 layers of 10mm GIB Braceline®/GIB Noiseline® fixed vertically.

Vertical joints of the outer layer are offset 600mm from those of the inner layer. Use full height sheets where possible. Sheet joints are touch fitted and must occur over framing. Where sheet end joints are unavoidable they must be over nogs and outer layer joints offset from those on the inner layer.

ACOUSTIC SEALANT

A bead of GIB Soundseal® acoustic sealant is required around the perimeter of the inner lining or framing. The outer lining is then bedded onto the bead.

FASTENING THE LINING

Fasteners

Inner or Single Layer: 25mm x 6g GIB® Grabber® High Thread Drywall Screws.

Outer layer: 41mm x 6g GIB® Grabber® High Thread Drywall Screws.

Fastener centres

Inner layer and outer layer: 300mm centres around sheet perimeter and 300mm to intermediate studs. Place fasteners 12mm from sheet edges.

JOINTING

Inner layer: Unstopped.

Outer layer: All fastener heads stopped and all sheet joints tape reinforced and stopped in accordance with the publication entitled GIB® Site Guide. Wall to ceiling junctions are to be reinforced with paper tape and square stopped or finished with GIB-Cove®.

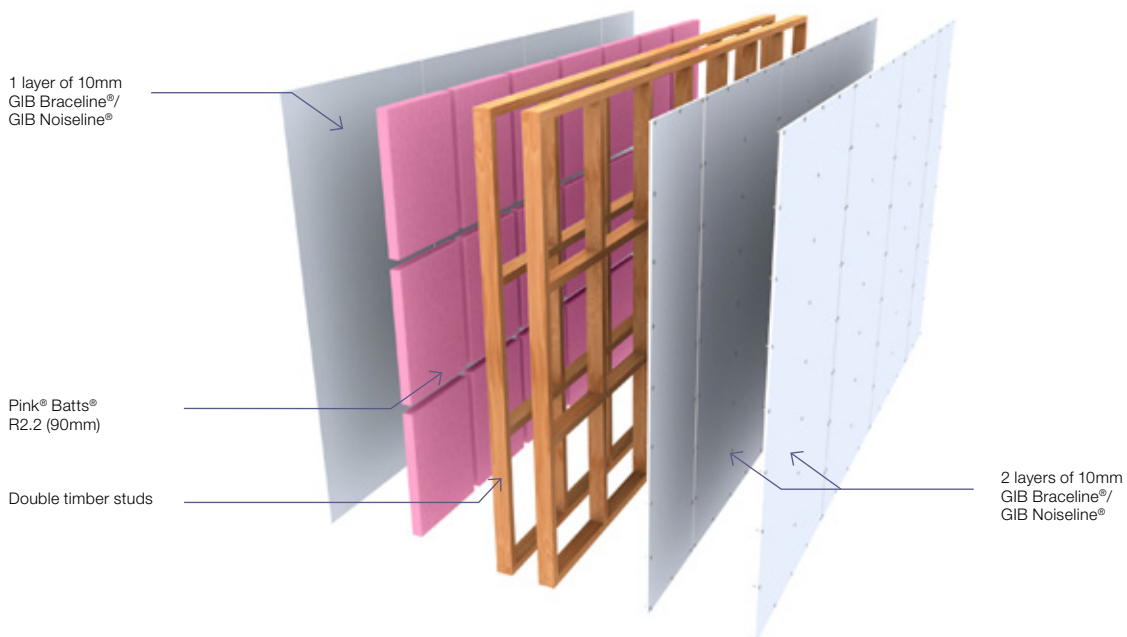

Two way FRR — double timber frame wall

Specification number	Performance	Specifications
GBTLA 60	STC 60	Lining 2 x 10mm GIB Fyreline® each side
	Rw 59	LB/NLB Load bearing
	FRR 60/60/60	Partition 245mm wide

FRAMING

Stud size	Space between frames
70mm	65mm min
90mm	25mm min

Framing to comply with:

- NZBC B1 — Structure: AS1 Clause 3 — Timber (NZS 3604) or VM1 Clause 6 — Timber (NZS 3603).
- NZBC B2 — Durability: AS1 Clause 3.2 — Timber (NZ 3602).
- Studs at 600mm centres maximum.
- Nogs at 1350mm centres maximum.

Framing dimensions and height as determined by NZS 3604 stud and top plate tables for load-bearing walls.

SOUND CONTROL INFILL

Pink® Batts® R2.2 (90mm) glass wool insulation installed between the studs and nogs on one side of the double frame.

WALL LINING

2 layers of 10mm GIB Fyreline® fixed vertically each side of the frame.

Vertical joints of the outer layer are offset 600mm from those of the inner layer. Use full height sheets where possible. Sheet joints are touch fitted and must occur over framing. Where sheet end joints are unavoidable they must be over nogs and outer layer joints offset from those on the inner layer.

ACOUSTIC SEALANT

A bead of GIB Soundseal® acoustic sealant is required around the perimeter of the inner lining. The outer lining is then bedded onto the bead.

FASTENING THE LINING

Fasteners

Inner layer: 41mm x 6g GIB® Grabber® High Thread Drywall Screw.

Outer layer: 51mm x 7g GIB® Grabber® High Thread Drywall Screw.

Fastener centres

Inner layer and outer layer: 300mm centres around sheet perimeter and 300mm to intermediate studs. Place fasteners 12mm from sheet edges.

JOINTING

Inner layer: Unstopped.

Outer layer: All fastener heads stopped and all sheet joints tape reinforced and stopped in accordance with the publication entitled GIB® Site Guide. Wall to ceiling junctions are to be reinforced with paper tape and square stopped or finished with GIB-Cove®.

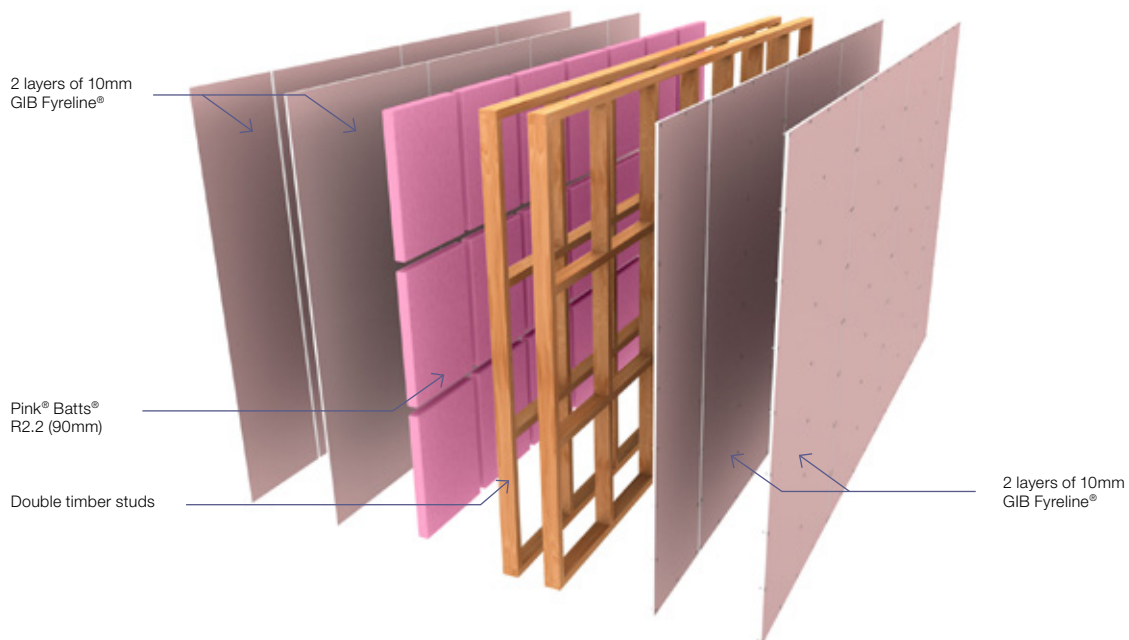

Two way FRR — double timber frame wall

Specification number	Performance	Specifications
GBTLA 90c	STC 63	Lining 2 x 13mm GIB Fyreline® each side
	Rw 62	LB/NLB Load bearing
	FRR 90/90/90	Partition 257mm wide

FRAMING

Stud size	Space between frames
70mm	65mm min
90mm	25mm min

Framing to comply with:

- NZBC B1 — Structure: AS1 Clause 3 — Timber (NZS 3604) or VM1 Clause 6 — Timber (NZS 3603).
- NZBC B2 — Durability: AS1 Clause 3.2 — Timber (NZ 3602).
- Studs at 600mm centres maximum.
- Nogs at 1350mm centres maximum.

Framing dimensions and height as determined by NZS 3604 stud and top plate tables for load-bearing walls.

SOUND CONTROL INFILL

Pink® Batts® R2.2 (90mm) glass wool insulation installed between the studs and nogs on one side of the double frame.

WALL LINING

2 layers of 13mm GIB Fyreline® fixed vertically each side of the frame.

Vertical joints of the outer layer are offset 600mm from those of the inner layer. Use full height sheets where possible. Sheet joints are touch fitted and must occur over framing. Where sheet end joints are unavoidable they must be over nogs and outer layer joints offset from those on the inner layer.

ACOUSTIC SEALANT

A bead of GIB Soundseal® acoustic sealant is required around the perimeter of the inner lining. The outer lining is then bedded onto the bead.

FASTENING THE LINING

Fasteners

Inner layer: 51mm x 7g GIB® Grabber® High Thread Drywall Screws.

Outer layer: 63mm x 8g GIB® Grabber® Self Tapping Drywall Screws.

Fastener centres

Inner layer and outer layer: 300mm centres around sheet perimeter and 300mm to intermediate studs. Place fasteners 12mm from sheet edges.

JOINTING

Inner layer: Unstopped.

Outer layer: All fastener heads stopped and all sheet joints tape reinforced and stopped in accordance with the publication entitled GIB® Site Guide. Wall to ceiling junctions are to be reinforced with paper tape and square stopped or finished with GIB-Cove®.

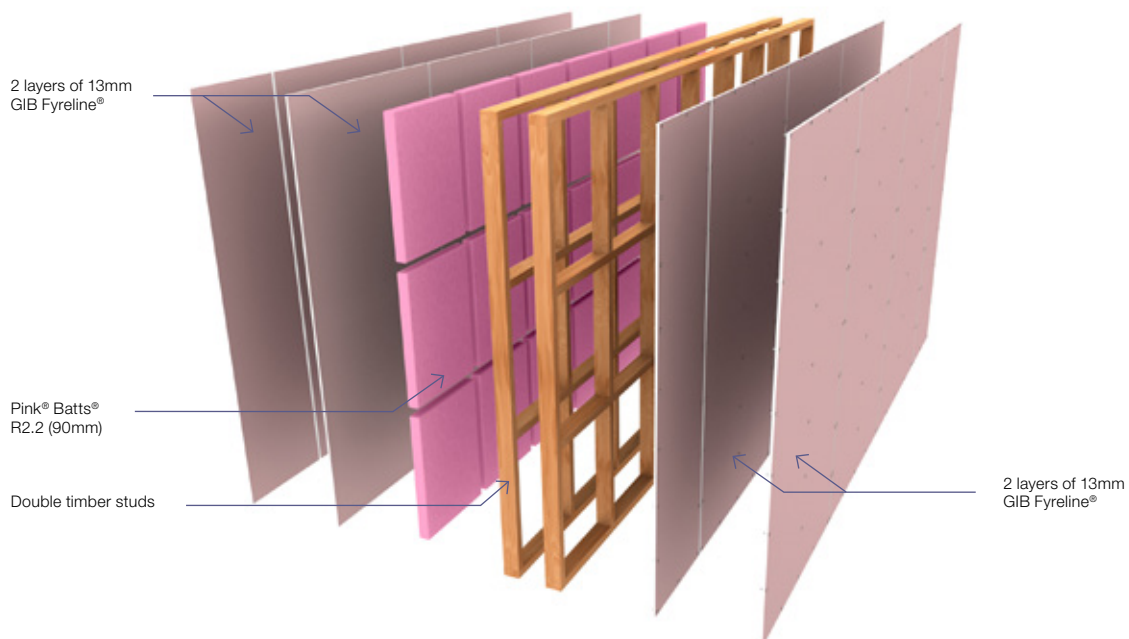

Two way FRR — double timber frame wall

Specification number	Performance	Specifications
GBTLA 90d	STC 67	Lining 2 x 13mm GIB Braceline®/GIB Noiseline® each side
	Rw 66	LB/NLB Load bearing
	FRR 90/90/90	Partition 257mm wide

FRAMING

Stud size	Space between frames
70mm	65mm min
90mm	25mm min

Framing to comply with:

- NZBC B1 — Structure: AS1 Clause 3 — Timber (NZS 3604) or VM1 Clause 6 — Timber (NZS 3603).
- NZBC B2 — Durability: AS1 Clause 3.2 — Timber (NZ 3602)
- Studs at 600mm centres maximum.
- Nogs at 1350mm centres maximum.

Framing dimensions and height as determined by NZS 3604 stud and top plate tables for load-bearing walls.

SOUND CONTROL INFILL

Pink® Batts® R2.2 (90mm) glass wool insulation installed between the studs and nogs on one side of the double frame.

WALL LINING

2 layers of 13mm GIB Braceline®/GIB Noiseline® fixed vertically each side of the frame.

Vertical joints of the outer layer are offset 600mm from those of the inner layer. Use full height sheets where possible. Sheet joints are touch fitted and must occur over framing. Where sheet end joints are unavoidable they must be over nogs and outer layer joints offset from those on the inner layer.

ACOUSTIC SEALANT

A bead of GIB Soundseal® acoustic sealant is required around the perimeter of the inner lining. The outer lining is then bedded onto the bead.

FASTENING THE LINING

Fasteners

Inner layer: 51mm x 7g GIB® Grabber® High Thread Drywall Screws.

Outer layer: 63mm x 8g GIB® Grabber® Self Tapping Drywall Screws.

Fastener centres

Inner layer and outer layer: 300mm centres around sheet perimeter and 300mm to intermediate studs. Place fasteners 12mm from sheet edges.

JOINTING

Inner layer: Unstopped.

Outer layer: All fastener heads stopped and all sheet joints tape reinforced and stopped in accordance with the publication entitled GIB® Site Guide. Wall to ceiling junctions are to be reinforced with paper tape and square stopped or finished with GIB-Cove®.

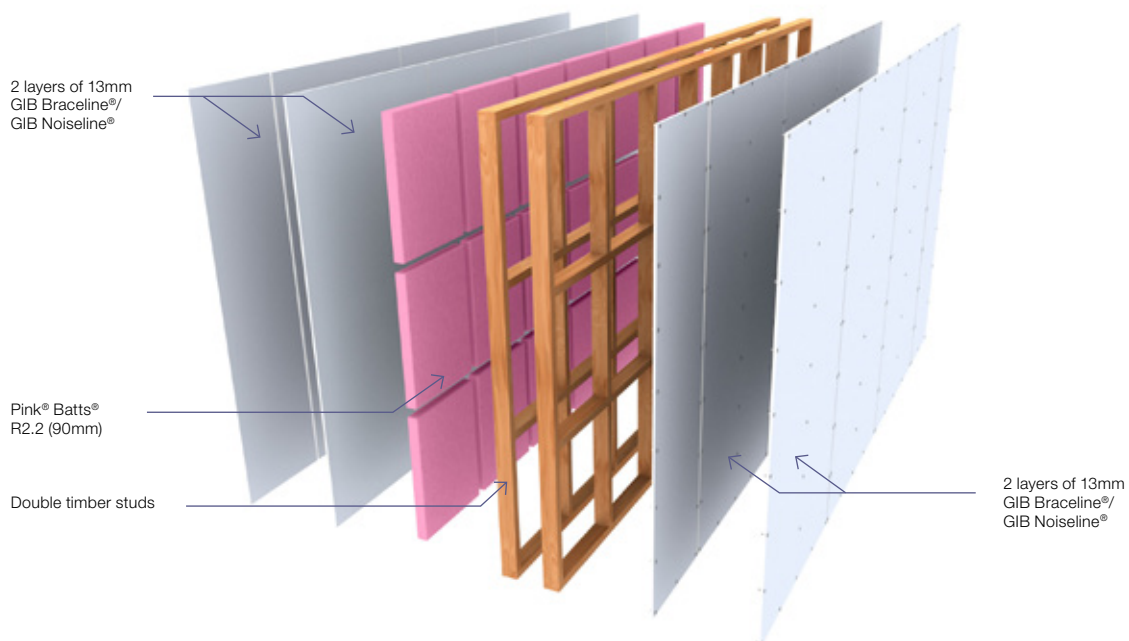

Two way FRR — double steel frame wall

Specification number	Performance	Specifications
GBSA 30b	STC 55	Lining 1 x 13mm GIB® Standard Plasterboard one side 2 x 13mm GIB® Standard Plasterboard other side
	Rw 56	
	FRR -/30/30	LB/NLB Non load bearing Partition 192mm wide

FRAMING

Stud size	Space between frames
64 x 34 x 0.50mm	25mm min

Steel stud dimensions 64 x 34 x 0.50mm BMT with 6mm return placed in 64 x 30 x 0.50mm BMT steel channel. Channel is fixed to floor and ceiling. Studs are friction fitted at 600mm centres maximum with a 15mm expansion gap at the top of the frame. No fixings to the top channel.

WALL HEIGHTS

Recommended maximum wall height is 2700mm. For greater wall heights refer to the steel stud centres and wall heights section on pages 14–15 of this publication.

SOUND CONTROL INFILL

Pink® Batts® BIB R1.8 (75mm) glass wool insulation installed between the studs on one side of the double frame.

WALL LINING

1 layer of 13mm GIB® Standard Plasterboard fixed vertically one side of the frame and 2 layers of 13mm GIB® Standard Plasterboard on the other.

Inner layer joints on opposite sides of the frame are offset. Vertical joints of the outer layer are offset 600mm from those of the inner layer. The inner layers must be fitted hard to floor. Use full height sheets where possible. Sheet joints are touch fitted and must occur over framing. Where sheet end joints are unavoidable they must be over nogs and outer layer joints offset from those on the inner layer.

ACOUSTIC SEALANT

A bead of GIB Soundseal® acoustic sealant is required around the perimeter of the inner lining. The outer lining is then bedded onto the bead.

FASTENING THE LINING

Fasteners

Inner and single layer: 25mm x 6g GIB® Grabber® Self Tapping Drywall Screws.

Outer layer: 41mm x 6g GIB® Grabber® Self Tapping Drywall Screws.

Fastener centres

Inner and outer layer: 300mm centres up each stud.

Place fasteners 12mm from sheet edges generally and 50mm from sheet ends.

JOINTING

Inner layer: Unstopped.

Outer layer: All fastener heads stopped and all sheet joints tape reinforced and stopped in accordance with the publication entitled GIB® Site Guide. Wall to ceiling junctions are to be reinforced with paper tape and square stopped or finished with GIB-Cove®.

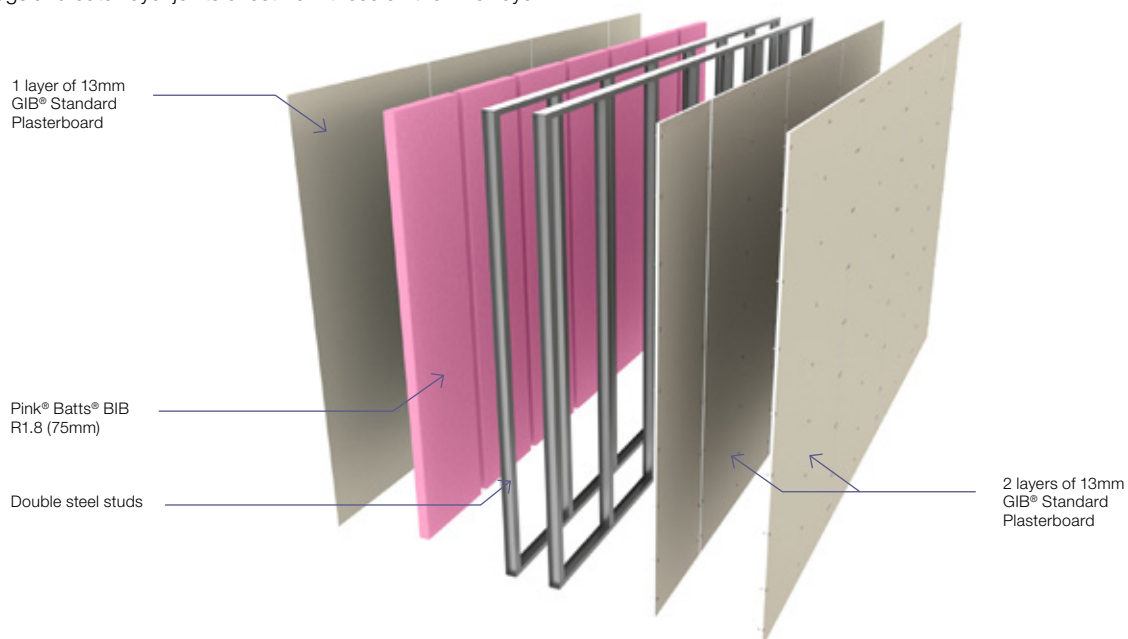

Two way FRR — double steel frame wall

Specification number	Performance	Specifications
GBSA 60c	STC 59	Lining 1 x 13mm GIB Fyreline® one side 2 x 10mm GIB Braceline®/GIB Noiseline® other side
	Rw 58	
	FRR -/60/60	LB/NLB Non load bearing Partition 186mm wide

FRAMING

Stud size	Space between frames
64 x 34 x 0.50mm	25mm min

Steel stud dimensions 64 x 34 x 0.50mm BMT with 6mm return placed in 64 x 30 x 0.50mm BMT steel channel. Channel is fixed to floor and ceiling. Studs are friction fitted at 600mm centres maximum with a 15mm expansion gap at the top of the frame. No fixings to the top channel.

WALL HEIGHTS

Recommended maximum wall height is 2700mm. For greater wall heights refer to the steel stud centres and wall heights section on pages 14–15 of this publication.

SOUND CONTROL INFILL

Pink® Batts® BIB R1.8 (75mm) glass wool insulation installed between the studs on one side of the double frame.

WALL LINING

1 layer of 13mm GIB Fyreline® fixed vertically one side of the frame and 2 layers of 10mm GIB Braceline®/GIB Noiseline® on the other.

Inner layer joints on opposite sides of the frame are offset. Vertical joints of the outer layer are offset 600mm from those of the inner layer. The inner layers must be fitted hard to floor. Use full height sheets where possible. Sheet joints are touch fitted and must occur over framing. Where sheet end joints are unavoidable they must be over nogs and outer layer joints offset from those on the inner layer.

ACOUSTIC SEALANT

A bead of GIB Soundseal® acoustic sealant is required around the perimeter of the inner lining. The outer lining is then bedded onto the bead.

FASTENING THE LINING

Fasteners

Inner and single layer: 25mm x 6g GIB® Grabber® Self Tapping Drywall Screws.

Outer layer: 41mm x 6g GIB® Grabber® Self Tapping Drywall Screws.

Fastener centres

Inner and outer layer: 300mm centres up each stud.

Place fasteners 12mm from sheet edges generally and 50mm from sheet ends.

JOINTING

Inner layer: Unstopped.

Outer layer: All fastener heads stopped and all sheet joints tape reinforced and stopped in accordance with the publication entitled GIB® Site Guide. Wall to ceiling junctions are to be reinforced with paper tape and square stopped or finished with GIB-Cove®.

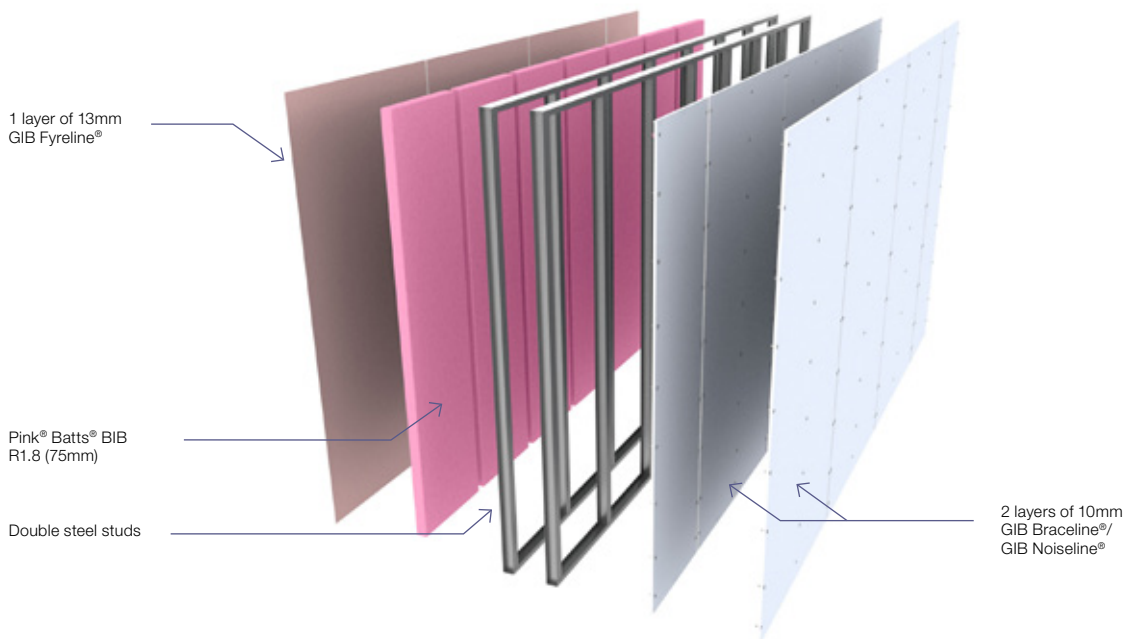

Two way FRR — double steel frame wall

Specification number	Performance	Specifications
GBSA 45	STC 60	Lining 2 x 13mm GIB® Standard Plasterboard each side
	Rw 59	LB/NLB Non load bearing
	FRR -/45/45	Partition 205mm wide

FRAMING

Stud size	Space between frames
64 x 34 x 0.50mm	25mm min

Steel stud dimensions 64 x 34 x 0.50mm BMT with 6mm return placed in 64 x 30 x 0.50mm BMT steel channel. Channel is fixed to floor and ceiling. Studs are friction fitted at 600mm centres maximum with a 15mm expansion gap at the top of the frame. No fixings to the top channel.

WALL HEIGHTS

Recommended maximum wall height is 2700mm. For greater wall heights refer to the steel stud centres and wall heights section on pages 14–15 of this publication.

SOUND CONTROL INFILL

Pink® Batts® BIB R1.8 (75mm) glass wool insulation installed between the studs on one side of the double frame.

WALL LINING

2 layers of 13mm GIB® Standard Plasterboard fixed vertically each side of the frame.

Inner layer joints on opposite sides of the frame are offset. Vertical joints of the outer layer are offset 600mm from those of the inner layer. The inner layers must be fitted hard to floor. Use full height sheets where possible. Sheet joints are touch fitted and must occur over framing. Where sheet end joints are unavoidable they must be over nogs and outer layer joints offset from those on the inner layer.

ACOUSTIC SEALANT

A bead of GIB Soundseal® acoustic sealant is required around the perimeter of the inner lining. The outer lining is then bedded onto the bead.

FASTENING THE LINING

Fasteners

Inner layer: 25mm x 6g GIB® Grabber® Self Tapping Drywall Screws.

Outer layer: 41mm x 6g GIB® Grabber® Self Tapping Drywall Screws.

Fastener centres

Inner and outer layer: 300mm centres up each stud.

Place fasteners 12mm from sheet edges generally and 50mm from sheet ends.

JOINTING

Inner layer: Unstopped.

Outer layer: All fastener heads stopped and all sheet joints tape reinforced and stopped in accordance with the publication entitled GIB® Site Guide. Wall to ceiling junctions are to be reinforced with paper tape and square stopped or finished with GIB-Cove®.

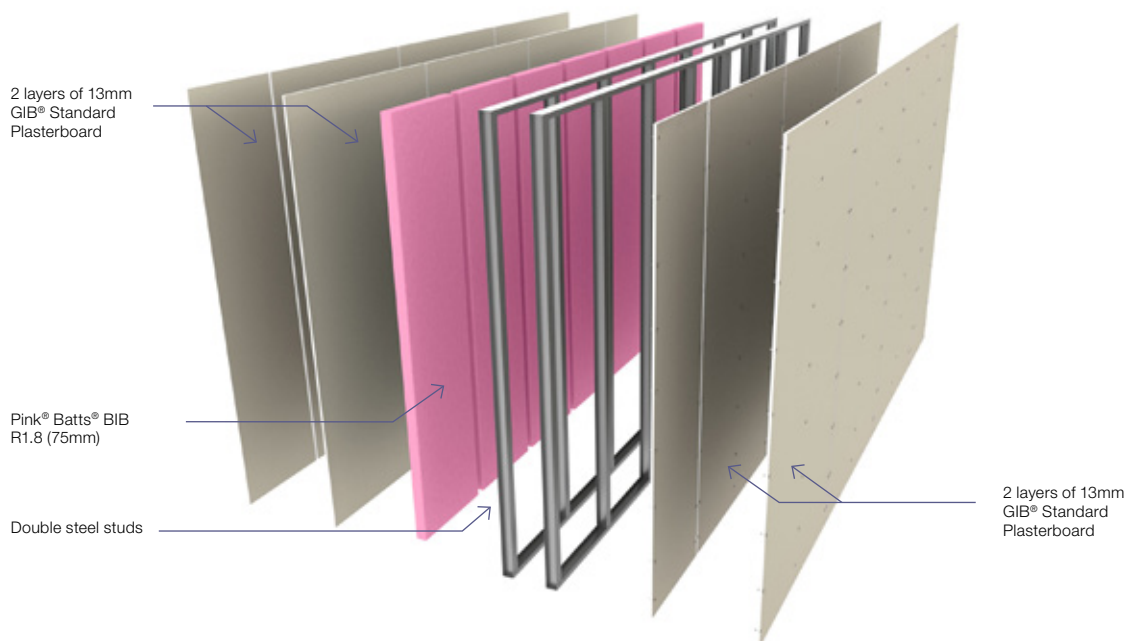

Two way FRR — double steel frame wall

Specification number	Performance	Specifications
GBSA 90c	STC 61	Lining 2 x 13mm GIB Fyreline® each side
	Rw 60	LB/NLB Non load bearing
	FRR -/90/90	Partition 205mm wide

FRAMING

Stud size	Space between frames
64 x 34 x 0.50mm	25mm min

Steel stud dimensions 64 x 34 x 0.50mm BMT with 6mm return placed in 64 x 30 x 0.50mm BMT steel channel. Channel is fixed to floor and ceiling. Studs are friction fitted at 600mm centres maximum with a 15mm expansion gap at the top of the frame. No fixings to the top channel.

WALL HEIGHTS

Recommended maximum wall height is 2700mm. For greater wall heights refer to the steel stud centres and wall heights section on pages 14–15 of this publication.

SOUND CONTROL INFILL

Pink® Batts® BIB R1.8 (75mm) glass wool insulation installed between the studs on one side of the double frame.

WALL LINING

2 layers of 13mm GIB Fyreline® fixed vertically each side of the frame. Inner layer joints on opposite sides of the frame are offset.

Vertical joints of the outer layer are offset 600mm from those of the inner layer. The inner layers must be fitted hard to floor. Use full height sheets where possible. Sheet joints are touch fitted and must occur over framing. Where sheet end joints are unavoidable they must be over nogs and outer layer joints offset from those on the inner layer.

ACOUSTIC SEALANT

A bead of GIB Soundseal® acoustic sealant is required around the perimeter of the inner lining. The outer lining is then bedded onto the bead.

FASTENING THE LINING

Fasteners

Inner layer: 25mm x 6g GIB® Grabber® Self Tapping Drywall Screws.

Outer layer: 41mm x 6g GIB® Grabber® Self Tapping Drywall Screws.

Fastener centres

Inner and outer layer: 300mm centres up each stud.

Place fasteners 12mm from sheet edges generally and 50mm from sheet ends.

JOINTING

Inner layer: Unstopped.

Outer layer: All fastener heads stopped and all sheet joints tape reinforced and stopped in accordance with the publication entitled GIB® Site Guide. Wall to ceiling junctions are to be reinforced with paper tape and square stopped or finished with GIB-Cove®.

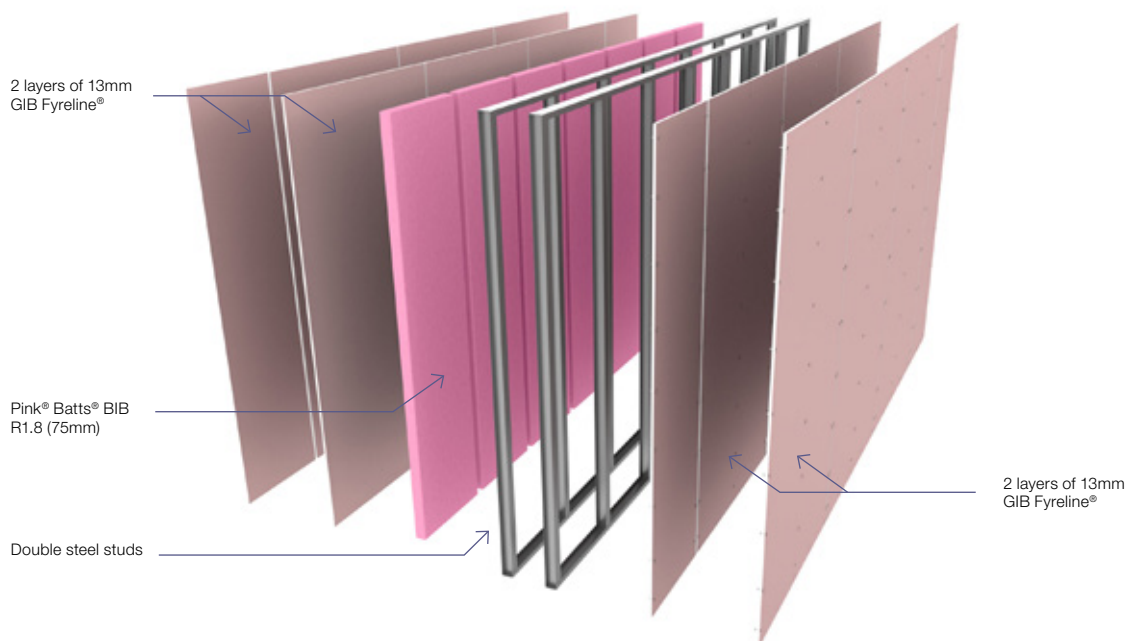

Two way FRR — double steel frame wall

Specification number	Performance	Specifications
GBSA 90d	STC 65	Lining 2 x 13mm GIB Braceline®/GIB Noiseline® each side
	Rw 65	LB/NLB Non load bearing
	FRR -/90/90	Partition 205mm wide

FRAMING

Stud size	Space between frames
64 x 34 x 0.50mm	25mm min

Steel stud dimensions 64 x 34 x 0.50mm BMT with 6mm return placed in 64 x 30 x 0.50mm BMT steel channel. Channel is fixed to floor and ceiling. Studs are friction fitted at 600mm centres maximum with a 15mm expansion gap at the top of the frame. No fixings to the top channel.

WALL HEIGHTS

Recommended maximum wall height is 2700mm. For greater wall heights refer to the steel stud centres and wall heights section on pages 14–15 of this publication.

SOUND CONTROL INFILL

Pink® Batts® BIB R1.8 (75mm) glass wool insulation installed between the studs on one side of the double frame.

WALL LINING

2 layers of 13mm GIB Braceline®/GIB Noiseline® fixed vertically each side of the frame.

Inner layer joints on opposite sides of the frame are offset. Vertical joints of the outer layer are offset 600mm from those of the inner layer. The inner layers must be fitted hard to floor. Use full height sheets where possible. Sheet joints are touch fitted and must occur over framing. Where sheet end joints are unavoidable they must be over nogs and outer layer joints offset from those on the inner layer.

ACOUSTIC SEALANT

A bead of GIB Soundseal® acoustic sealant is required around the perimeter of the inner lining. The outer lining is then bedded onto the bead.

FASTENING THE LINING

Fasteners

Inner layer: 25mm x 6g GIB® Grabber® Self Tapping Drywall Screws.

Outer layer: 41mm x 6g GIB® Grabber® Self Tapping Drywall Screws.

Fastener centres

Inner and outer layer: 300mm centres up each stud.

Place fasteners 12mm from sheet edges generally and 50mm from sheet ends.

JOINTING

Inner layer: Unstopped.

Outer layer: All fastener heads stopped and all sheet joints tape reinforced and stopped in accordance with the publication entitled GIB® Site Guide. Wall to ceiling junctions are to be reinforced with paper tape and square stopped or finished with GIB-Cove®.

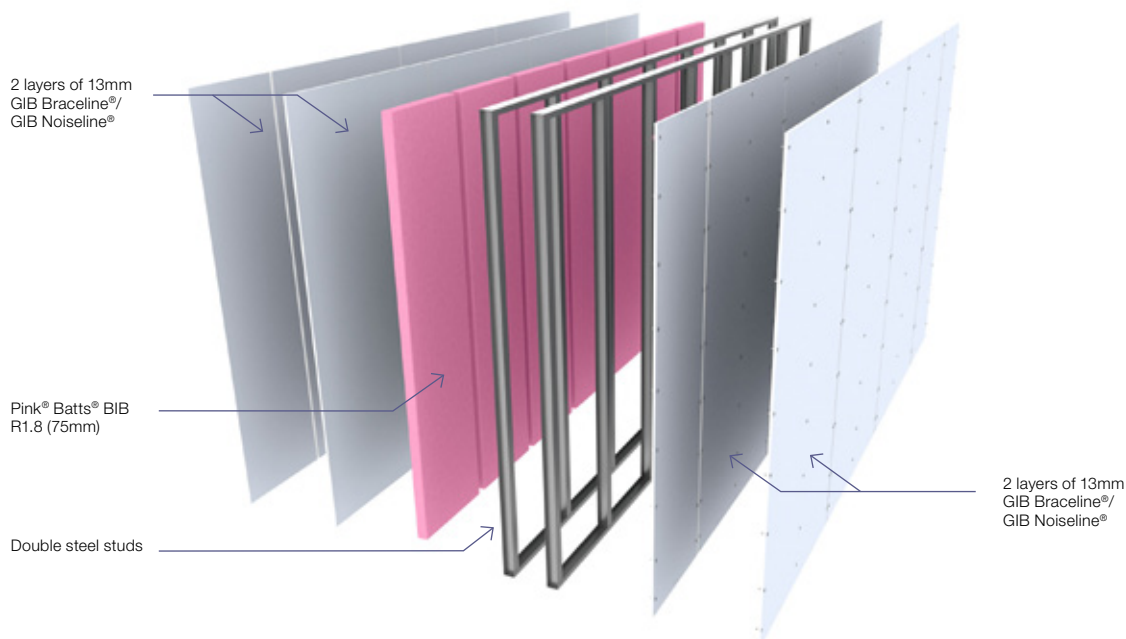

Two way FRR — timber frame wall — GIB Rail®

Specification number	Performance	Specifications
GBTLA 45r	STC 55	Lining 2 x 13mm GIB® Standard Plasterboard each side
	Rw 54	LB/NLB Load bearing
	FRR 45/45/45	Partition 155mm wide

FRAMING

Stud size	Space between frames
90mm	N/A

Framing to comply with:

- NZBC B1 — Structure: AS1 Clause 3 — Timber (NZS 3604) or VM1 Clause 6 — Timber (NZS 3603).
- NZBC B2 — Durability: AS1 Clause 3.2 — Timber (NZ 3602).
- Studs at 600mm centres maximum.
- Nogs at 1350mm centres maximum.

Height as determined by NZS 3604 stud and top plate tables for load-bearing walls.

SOUND CONTROL INFILL

Pink® Batts® R2.2 (90mm) glass wool insulation installed between the studs and nogs.

FASTENING THE GIB RAIL®

The rail shall be fixed horizontally at 600mm centres using 32mm x 8g GIB® Grabber® Wafer Head Self Tapping Screws through the base flange into each stud. The base flange shall point downwards and the open edge upwards. The top rail shall be fastened with its upper edge below the top plate but no more than 75mm below the ceiling line. The bottom rail 50mm from the floor line. The bottom rail only may be fixed with its base flange up or down for ease of attachment. Splice rails directly over the studs by nestling (not butting) with no more than a 20mm overlap. Drive the fastener through both flanges into the stud.

WALL LINING

2 layers of 13mm GIB® Standard Plasterboard fixed vertically each side of the frame.

Vertical joints of the outer layer are offset 600mm from those of the inner layer. Use full height sheets where possible. Sheet joints

are touch fitted and must occur over timber on the framing side. Where sheet end joints are unavoidable they must be over nogs or rail and outer layer joints offset from those on the inner layer.

ACOUSTIC SEALANT

A bead of GIB Soundseal® acoustic sealant is required around the perimeter of the inner lining. The outer lining is then bedded onto the bead.

FASTENING THE LINING

Fasteners

Framing side

Inner layer: 41mm x 6g GIB® Grabber® High Thread Drywall Screws.

Outer layer: 51mm x 7g GIB® Grabber® High Thread Drywall Screws.

GIB Rail® side

Inner layer: 25mm x 6g GIB® Grabber® Self Tapping Drywall Screws.

Outer layer: 41mm x 6g GIB® Grabber® Self Tapping Drywall Screws.

Fastener centres

Fixings at 300mm centres to each stud and plate, and along each rail. Place fasteners no closer than 12mm to sheet edges.

Warning: Systems that utilise GIB Rail® require particular attention to ensure the sheet fasteners do not compromise acoustic performance. When fastening the lining through the GIB Rail®, set the screws to the side of the studs. The screws must not touch or penetrate the framing. Marking the position of the studs on the floor will help to avoid screwing into the studs.

JOINTING

Inner layer: Unstopped.

Outer layer: All fastener heads stopped and all sheet joints tape reinforced and stopped in accordance with the publication entitled GIB® Site Guide. Wall to ceiling junctions are to be reinforced with paper tape and square stopped or finished with GIB-Cove®.

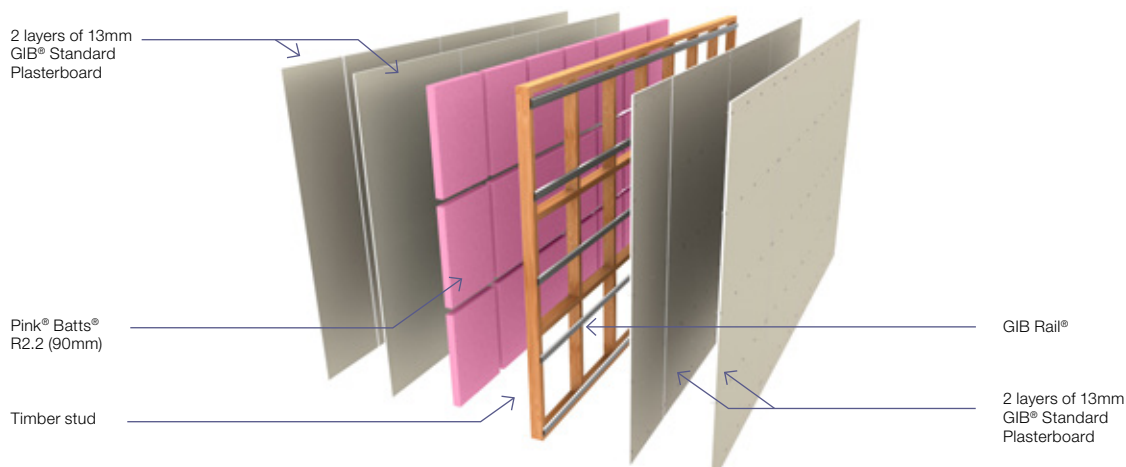

Two way FRR — timber frame wall — GIB Rail®

Specification number	Performance	Specifications
GBTLA 60r	STC 55	Lining 2 x 10mm GIB Braceline®/GIB Noiseline® each side
	Rw 54	LB/NLB Load bearing
	FRR 60/60/60	Partition 143mm wide

FRAMING

Stud size	Space between frames
90mm	N/A

Framing to comply with:

- NZBC B1 — Structure: AS1 Clause 3 — Timber (NZS 3604) or VM1 Clause 6 — Timber (NZS 3603).
- NZBC B2 — Durability: AS1 Clause 3.2 — Timber (NZ 3602).
- Studs at 600mm centres maximum.
- Nogs at 1350mm centres maximum.

Height as determined by NZS 3604 stud and top plate tables for load-bearing walls.

SOUND CONTROL INFILL

Pink® Batts® R2.2 (90mm) glass wool insulation installed between the studs and nogs.

FASTENING THE GIB RAIL®

The rail shall be fixed horizontally at 600mm centres using 32mm x 8g GIB® Grabber® Wafer Head Self Tapping Screws through the base flange into each stud. The base flange shall face downwards and the open edge upwards. The top rail shall be fastened with its upper edge below the top plate but no more than 75mm below the ceiling line. Bottom rail 50mm from the floor line. The bottom rail only may be fixed with its base flange up or down for ease of attachment. Splice rails directly over the studs by nestling (not butting) with no more than a 20mm overlap. Drive the fastener through both flanges into the stud.

WALL LINING

2 layers of 10mm GIB Braceline®/GIB Noiseline® fixed vertically each side of the frame.

Vertical joints of the outer layer are offset 600mm from those of the inner layer. Use full height sheets where possible. Sheet joints

are touch fitted and must occur over timber on the framing side. Where sheet end joints are unavoidable they must be over nogs or rail and the outer layer joints offset from those on the inner layer.

ACOUSTIC SEALANT

A bead of GIB Soundseal® acoustic sealant is required around the perimeter of the inner lining. The outer lining is then bedded onto the bead.

FASTENING THE LINING

Fasteners

Framing side

Inner layer: 41mm x 6g GIB® Grabber® High Thread Drywall Screws.

Outer layer: 51mm x 7g GIB® Grabber® High Thread Drywall Screws.

GIB Rail® side

Inner layer: 25mm x 6g GIB® Grabber® Self Tapping Drywall Screws.

Outer layer: 41mm x 6g GIB® Grabber® Self Tapping Drywall Screws.

Fastener centres

Fixings at 300mm centres to each stud and plate, and along each rail. Place fasteners no closer than 12mm to sheet edges.

Warning: Systems that utilise GIB Rail® require particular attention to ensure the sheet fasteners do not compromise acoustic performance. When fastening the lining through the GIB Rail®, set the screws to the side of the studs. The screws must not touch or penetrate the framing. Marking the position of the studs on the floor will help to avoid screwing into the studs.

JOINTING

Inner layer: Unstopped.

Outer layer: All fastener heads stopped and all sheet joints tape reinforced and stopped in accordance with the publication entitled GIB® Site Guide. Wall to ceiling junctions are to be reinforced with paper tape and square stopped or finished with GIB-Cove®.

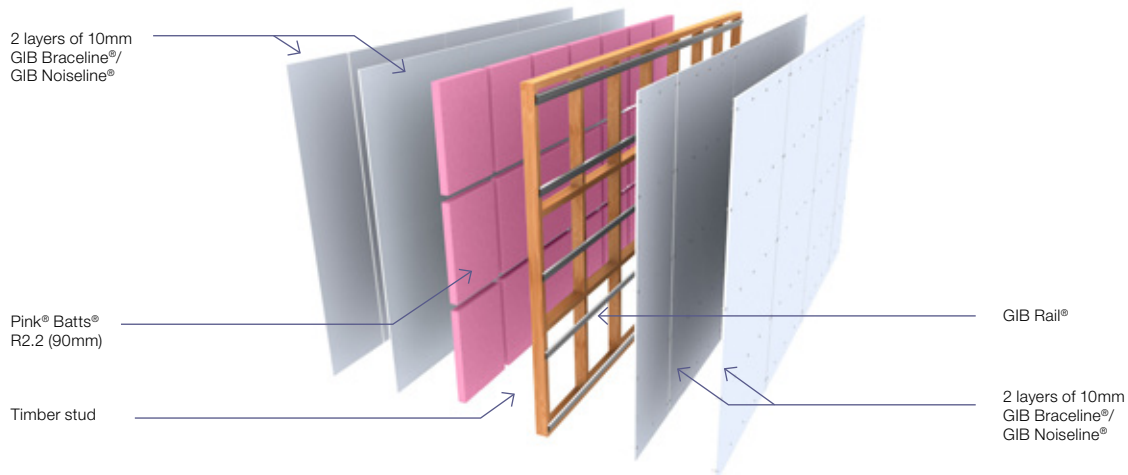

Two way FRR — timber frame wall — GIB Rail®

Specification number	Performance	Specifications
GBTLA 90r	STC 55	Lining 2 x 13mm GIB Fyreline® each side
	Rw 55	LB/NLB Load bearing
	FRR 90/90/90	Partition 155mm wide

FRAMING

Stud size	Space between frames
90mm	N/A

Framing to comply with:

- NZBC B1 — Structure: AS1 Clause 3 — Timber (NZS 3604) or VM1 Clause 6 — Timber (NZS 3603).
- NZBC B2 — Durability: AS1 Clause 3.2 — Timber (NZ 3602).
- Studs at 600mm centres maximum.
- Nogs at 1350mm centres maximum.

Height as determined by NZS 3604 stud and top plate tables for load-bearing walls.

SOUND CONTROL INFILL

Pink® Batts® R2.2 (90mm) glass wool insulation installed between the studs and nogs.

FASTENING THE GIB RAIL®

The rail shall be fixed horizontally at 600mm centres using 32mm x 8g GIB® Grabber® Wafer Head Self Tapping Screws through the base flange into each stud. The base flange shall face downwards and the open edge upwards. The top rail shall be fastened with its upper edge below the top plate but no more than 75mm below the ceiling line. Bottom rail 50mm from the floor line. The bottom rail only may be fixed with its base flange up or down for ease of attachment.

Splice rails directly over the studs by nestling (not butting) with no more than a 20mm overlap. Drive the fastener through both flanges into the stud.

WALL LINING

2 layers of 13mm GIB Fyreline® fixed vertically each side of the frame. Vertical joints of the outer layer are offset 600mm from those of the inner layer.

Use full height sheets where possible. Sheet joints are touch fitted and must occur over timber on the framing side. Where sheet end joints are unavoidable they must be over nogs or rail and the outer layer joints offset from those on the inner layer.

ACOUSTIC SEALANT

A bead of GIB Soundseal® acoustic sealant is required around the perimeter of the inner lining. The outer lining is then bedded onto the bead.

FASTENING THE LINING

Fasteners

Framing side

Inner layer: 41mm x 6g GIB® Grabber® High Thread Drywall Screws.

Outer layer: 51mm x 7g GIB® Grabber® High Thread Drywall Screws.

GIB Rail® side

Inner layer: 25mm x 6g GIB® Grabber® Self Tapping Drywall Screws.

Outer layer: 41mm x 6g GIB® Grabber® Self Tapping Drywall Screws.

Fastener centres

Fixings at 300mm centres to each stud and plate, and along each rail. Place fasteners no closer than 12mm to sheet edges.

Warning: Systems that utilise GIB Rail® require particular attention to ensure the sheet fasteners do not compromise acoustic performance. When fastening the lining through the GIB Rail®, set the screws to the side of the studs. The screws must not touch or penetrate the framing. Marking the position of the studs on the floor will help to avoid screwing into the studs.

JOINTING

Inner layer: Unstopped.

Outer layer: All fastener heads stopped and all sheet joints tape reinforced and stopped in accordance with the publication entitled GIB® Site Guide. Wall to ceiling junctions are to be reinforced with paper tape and square stopped or finished with GIB-Cove®.

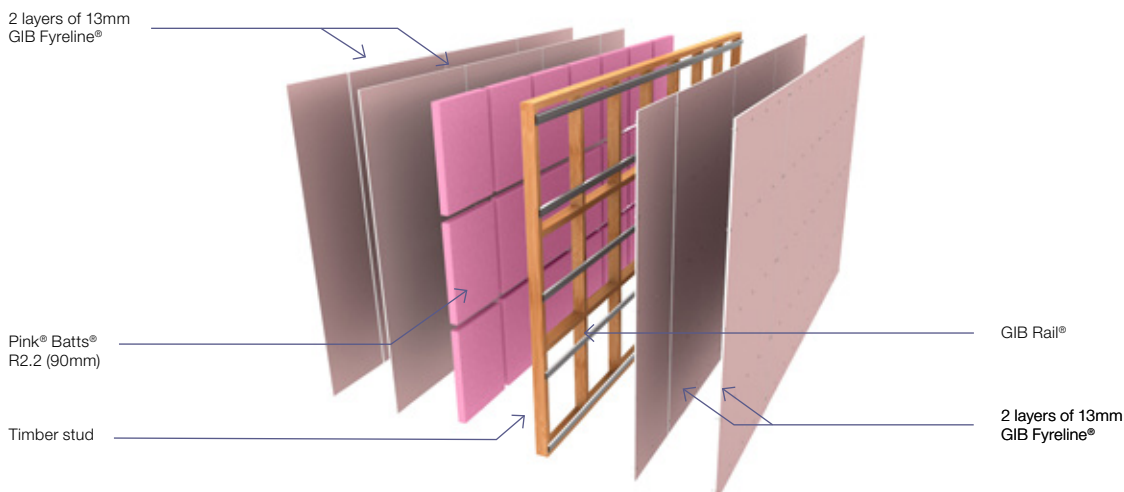

Two way FRR — timber frame wall — acoustic resilient mount

Specification number	Performance	Specifications
GBTLIC 45	STC 61	Lining 2 x 13mm GIB® Standard Plasterboard each side
	Rw 59	LB/NLB Load bearing
	FRR 45/45/45	Partition 182mm wide

FRAMING

Stud size	Space between frames
90mm	N/A

Framing to comply with:

- NZBC B1 — Structure: AS1 Clause 3 — Timber (NZS 3604) or VM1 Clause 6 — Timber (NZS 3603).
- NZBC B2 — Durability: AS1 Clause 3.2 — Timber (NZ 3602).
- Studs at 600mm centres maximum.
- Nogs at 1350mm centres maximum.

Height as determined by NZS 3604 stud and top plate tables for load-bearing walls.

SOUND CONTROL INFILL

Pink® Batts® R2.2 (90mm) glass wool insulation installed between the studs and nogs.

ACOUSTIC RESILIENT MOUNT (ST-001)

The ST-001 clip is placed at 600mm centres vertically and fixed every second stud using a single 63mm x 8g self tapping screw. When adjusting the clip for depth, 3mm of rubber must remain between the underside of the steel spacerhead and the furring channel.

The furring channels must be either USG FC37 or Rondo® 308. Furring channels are clipped horizontally into the ST-001 clips. Joints must be made as close as possible to the ST-001 clips.

WALL LINING

2 layers of 13mm GIB® Standard Plasterboard fixed vertically to the frame on one side and to the furring channel on the other.

Vertical joints of the outer layer are offset 600mm from those of the inner layer. Use full height sheets where possible. Sheet joints are touch fitted and must occur over timber on the framing side. Where sheet end joints are unavoidable they must be over nogs or the furring channel, and outer layer joints offset from those on the inner layer.

ACOUSTIC SEALANT

A bead of GIB Soundseal® acoustic sealant is required around the perimeter of the inner lining. The outer lining is then bedded onto the bead.

FASTENING THE LINING

Fasteners

Framing side

Inner layer: 41mm x 6g GIB® Grabber® High Thread Drywall Screws.

Outer layer: 51mm x 7g GIB® Grabber® High Thread Drywall Screws.

Furring channel side

Inner layer: 25mm x 6g GIB® Grabber® Self Tapping Drywall Screws.

Outer layer: 41mm x 6g GIB® Grabber® Self Tapping Drywall Screws.

Fastener centres

Fixings at 300mm centres to each stud and plate, and along each furring channel. Place fasteners no closer than 12mm to sheet edges.

JOINTING

Inner layer: Unstopped.

Outer layer: All fastener heads stopped and all sheet joints tape reinforced and stopped in accordance with the publication entitled GIB® Site Guide. Wall to ceiling junctions are to be reinforced with paper tape and square stopped or finished with GIB-Cove®.

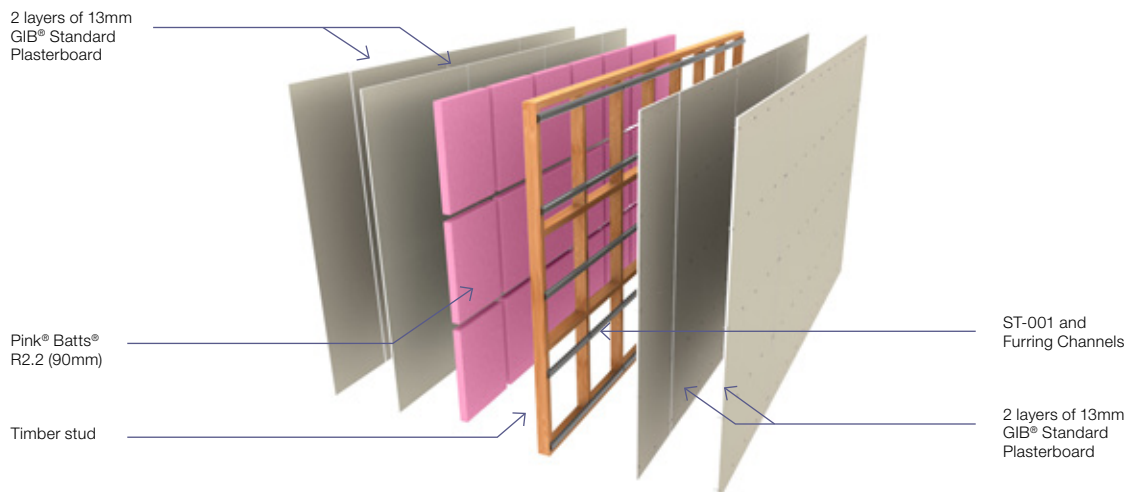

Two way FRR — timber frame wall — acoustic resilient mount

Specification number	Performance	Specifications
GBTLIC 60	STC 62	Lining 2 x 10mm GIB Braceline®/GIB Noiseline® each side
	Rw 60	LB/NLB Load bearing
	FRR 60/60/60	Partition 170–175mm wide

FRAMING

Stud size	Space between frames
90mm	N/A

Framing to comply with:

- NZBC B1 — Structure: AS1 Clause 3 — Timber (NZS 3604) or VM1 Clause 6 — Timber (NZS 3603).
- NZBC B2 — Durability: AS1 Clause 3.2 — Timber (NZ 3602).
- Studs at 600mm centres maximum.
- Nogs at 1350mm centres maximum.

Height as determined by NZS 3604 stud and top plate tables for load-bearing walls.

SOUND CONTROL INFILL

Pink® Batts® R2.2 (90mm) glass wool insulation installed between the studs and nogs.

ACOUSTIC RESILIENT MOUNT (ST-001)

The ST-001 clip is placed at 600mm centres vertically and fixed every second stud using a single 63mm x 8g self tapping screw. When adjusting the clip for depth, 3mm of rubber must remain between the underside of the steel spacerhead and the furring channel.

The furring channels must be either USG FC37 or Rondo® 308. Furring channels are clipped horizontally into the ST-001 clips. Joints must be made as close as possible to the ST-001 clips.

WALL LINING

2 layers of 10mm GIB Braceline®/GIB Noiseline® fixed vertically each side of the frame.

Vertical joints of the outer layer are offset 600mm from those of the inner layer. Use full height sheets where possible. Sheet joints are touch fitted and must occur over timber on the framing side. Where sheet end joints are unavoidable they must be over nogs and the outer layer joints offset from those on the inner layer.

ACOUSTIC SEALANT

A bead of GIB Soundseal® acoustic sealant is required around the perimeter of the inner lining. The outer lining is then bedded onto the bead.

FASTENING THE LINING

Fasteners

Framing side

Inner layer: 41mm x 6g GIB® Grabber® High Thread Drywall Screws.

Outer layer: 51mm x 7g GIB® Grabber® High Thread Drywall Screws.

Furring channel side

Inner layer: 25mm x 6g GIB® Grabber® Self Tapping Drywall Screws.

Outer layer: 41mm x 6g GIB® Grabber® Self Tapping Drywall Screws.

Fastener centres

Fixings at 300mm centres to each stud and plate, and along each furring channel. Place fasteners no closer than 12mm to sheet edges.

JOINTING

Inner layer: Unstopped.

Outer layer: All fastener heads stopped and all sheet joints tape reinforced and stopped in accordance with the publication entitled GIB® Site Guide. Wall to ceiling junctions are to be reinforced with paper tape and square stopped or finished with GIB-Cove®.

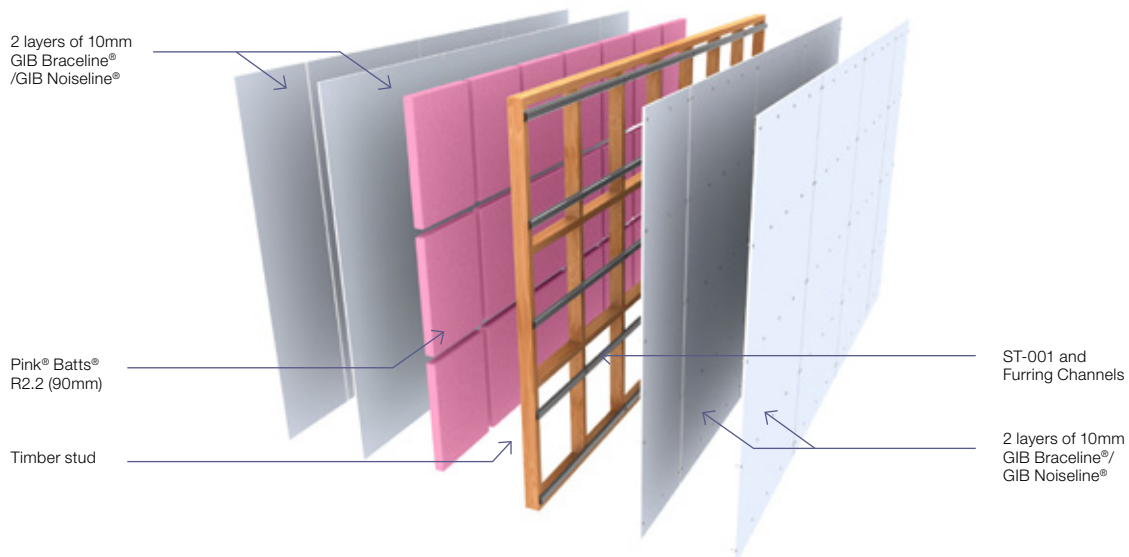

Two way FRR — timber frame wall — acoustic resilient mount

Specification number	Performance	Specifications
GBTLIC 60a	STC 57 Rw 56 FRR 60/60/60	Lining Framing side 1 x 13mm GIB Braceline®/GIB Noiseline® Furring Channel side 2 x 13mm GIB Braceline®/ GIB Noiseline® LB/NLB Load bearing Partition 169–174mm wide

FRAMING

Stud size	Space between frames
90mm	N/A

Framing to comply with:

- NZBC B1 — Structure: AS1 Clause 3 — Timber (NZS 3604) or VM1 Clause 6 — Timber (NZS 3603).
- NZBC B2 — Durability: AS1 Clause 3.2 — Timber (NZ 3602).
- Studs at 600mm centres maximum.
- Nogs at 1350mm centres maximum.

Height as determined by NZS 3604 stud and top plate tables for load-bearing walls.

SOUND CONTROL INFILL

Pink® Batts® R2.2 (90mm) glass wool insulation installed between the studs and nogs.

ACOUSTIC RESILIENT MOUNT (ST-001)

The ST-001 clip is placed at 600mm centres vertically and fixed every second stud using a single 63mm x 8g self tapping screw. When adjusting the clip for depth, 3mm of rubber must remain between the underside of the steel spacerhead and the furring channel.

The furring channels must be either USG FC37 or Rondo® 308. Furring channels are clipped horizontally into the ST-001 clips. Joints must be made as close as possible to the ST-001 clips.

WALL LINING

Framing side: 1 layer of 13mm GIB Braceline®/GIB Noiseline®.

Furring channel side: 2 layers of 13mm GIB Braceline®/GIB Noiseline® fixed vertically.

Vertical joints of the outer layer are offset 600mm from those of the inner layer. Use full height sheets where possible. Sheet joints are touch fitted and must occur over timber on the framing side. Where sheet end joints are unavoidable they must be over nogs and outer layer joints offset from those on the inner layer.

ACOUSTIC SEALANT

A bead of GIB Soundseal® acoustic sealant is required around the perimeter of the inner frame or lining. The outer lining is then bedded onto the bead.

FASTENING THE LINING

Fasteners

Framing side

51mm x 7g GIB® Grabber® High Thread Drywall Screws.

Furring channel side

Inner layer: 25mm x 6g GIB® Grabber® Self Tapping Drywall Screws.

Outer layer: 41mm x 6g GIB® Grabber® Self Tapping Drywall Screws.

Fastener centres

Fixings at 300mm centres to each stud and plate, and along each furring channel. Place fasteners no closer than 12mm to sheet edges.

JOINTING

Inner layer: Unstopped.

Outer layer: All fastener heads stopped and all sheet joints tape reinforced and stopped in accordance with the publication entitled GIB® Site Guide. Wall to ceiling junctions are to be reinforced with paper tape and square stopped or finished with GIB-Cove®.

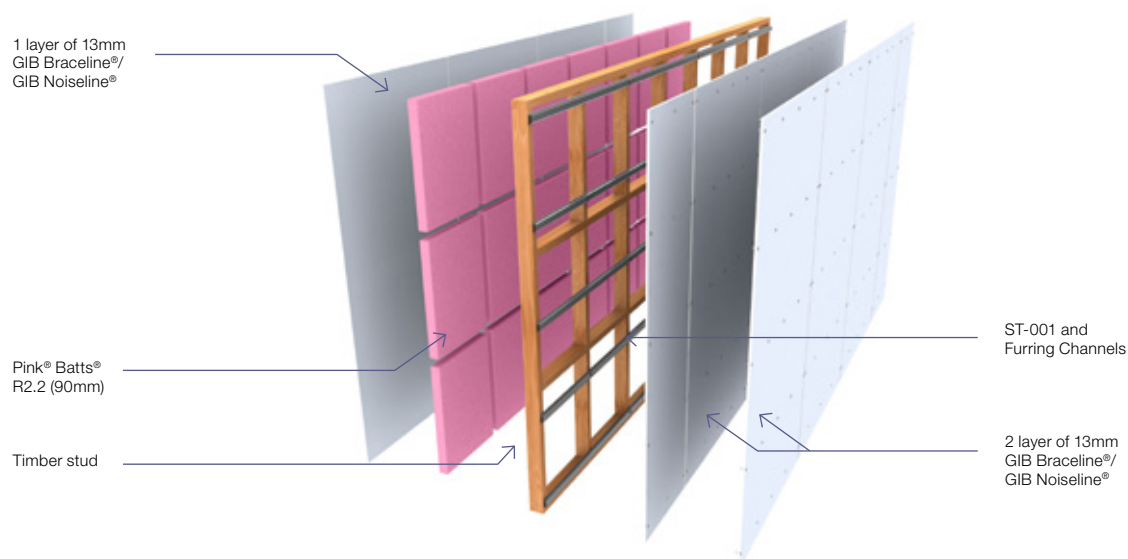

Two way FRR — steel frame wall — GIB Rail®

Specification number	Performance	Specifications
GBSA 30r	STC 55	Lining 2 x 13mm GIB® Standard Plasterboard each side
	Rw 55	LB/NLB Non load bearing
	FRR -/30/30	Partition 129mm wide

FRAMING

Stud size	Space between frames
64 x 34 x 0.50mm	N/A

Steel stud dimensions 64 x 34 x 0.50mm BMT with 6mm return placed in 64 x 30 x 0.50mm BMT steel channel. Channel is fixed to floor and ceiling. Studs are friction fitted at 600mm centres maximum with a 15mm expansion gap at the top of the frame. No fixings to the top channel.

WALL HEIGHTS

Recommended maximum wall height is 2700mm. For greater wall heights refer to the steel stud centres and wall heights section on pages 14–15 of this publication.

SOUND CONTROL INFILL

Pink® Batts® BIB R1.8 (75mm) glass wool insulation installed between the studs.

FASTENING THE GIB RAIL®

The rail shall be fixed horizontally at 600mm centres using 32mm x 8g GIB® Grabber® Wafer Head Self Tapping Screws through the base flange into each stud. The base flange shall point downwards and the open edge upwards.

The top rail shall be fastened with its upper edge below the top channel but no more than 75mm below the ceiling line. The bottom rail 50mm from the floor line. The bottom rail only may be fixed with its base flange up or down for ease of attachment. Splice rails directly over the studs by nestling (not butting) with no more than a 20mm overlap. Drive the fastener through both flanges into the stud.

WALL LINING

2 layers of 13mm GIB® Standard Plasterboard fixed vertically each side of the frame.

Vertical joints of the outer layer are offset 600mm from those of the inner layer. Use full height sheets where possible. Sheet joints are

touch fitted and must occur over studs on the framing side. Where sheet end joints are unavoidable they must be over nogs and the outer layer joints offset from those on the inner layer.

ACOUSTIC SEALANT

A bead of GIB Soundseal® acoustic sealant is required around the perimeter of the inner lining. The outer lining is then bedded onto the bead.

FASTENING THE LINING

Fasteners

Framing side

Inner layer: 25mm x 6g GIB® Grabber® Self Tapping Drywall Screws.

Outer layer: 41mm x 6g GIB® Grabber® Self Tapping Drywall Screws.

GIB Rail® side

Inner layer: 25mm x 6g GIB® Grabber® Self Tapping Drywall Screws.

Outer layer: 41mm x 6g GIB® Grabber® Self Tapping Drywall Screws.

Fastener centres

Fixings at 300mm centres to each stud and along each rail.

Place fasteners 12mm from sheet edges generally and 50mm from sheet ends.

Warning: Systems that utilise GIB Rail® require particular attention to ensure the sheet fasteners do not compromise acoustic performance. When fastening the lining through the GIB Rail®, set the screws to the side of the studs. The screws must not touch or penetrate the framing. Marking the position of the studs on the floor will help to avoid screwing into the studs.

JOINTING

Inner layer: Unstopped.

Outer layer: All fastener heads stopped and all sheet joints tape reinforced and stopped in accordance with the publication entitled GIB® Site Guide. Wall to ceiling junctions are to be reinforced with paper tape and square stopped or finished with GIB-Cove®.

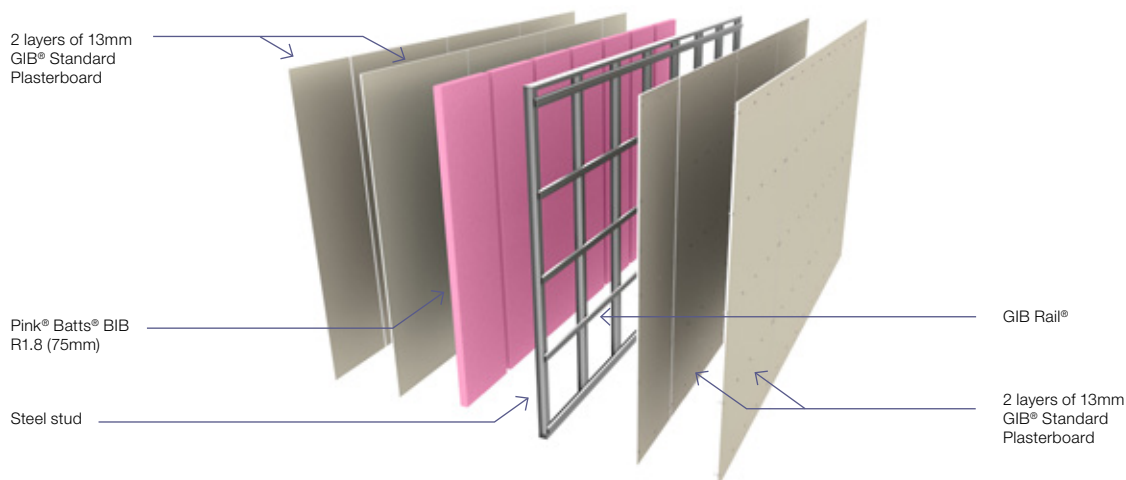

Two way FRR — steel frame wall— GIB Rail®

Specification number	Performance	Specifications
GBSA 60r	STC 55	Lining 2 x 10mm GIB Braceline®/GIB Noiseline® each side
	Rw 54	LB/NLB Non load bearing
	FRR –/60/60	Partition 117mm wide

FRAMING

Stud size	Space between frames
64 x 34 x 0.50mm	N/A

Steel stud dimensions 64 x 34 x 0.50mm BMT with 6mm return placed in 64 x 30 x 0.50mm BMT steel channel. Channel is fixed to floor and ceiling. Studs are friction fitted at 600mm centres maximum with a 15mm expansion gap at the top of the frame. No fixings to the top channel.

WALL HEIGHTS

Recommended maximum wall height is 2700mm. For greater wall heights refer to steel stud centres and wall heights section on pages 14–15 of this publication.

SOUND CONTROL INFILL

Pink® Batts® BIB R1.8 (75mm) glass wool insulation installed between the studs.

FASTENING THE GIB RAIL®

The rail shall be fixed horizontally at 600mm centres using 32mm x 8g GIB® Grabber® Wafer Head Self Tapping Screws through the base flange into each stud. The base flange shall point downwards and the open edge upwards.

The top rail shall be fastened with its upper edge below the top channel but no more than 75mm below the ceiling line. The bottom rail 50mm from the floor line. The bottom rail only may be fixed with its base flange up or down for ease of attachment. Splice rails directly over the studs by nestling (not butting) with no more than a 20mm overlap. Drive the fastener through both flanges into the stud.

WALL LINING

2 layers of 10mm GIB Braceline®/GIB Noiseline® fixed vertically each side of the frame.

Vertical joints of the outer layer are offset 600mm from those of the

inner layer. Use full height sheets where possible. Sheet joints are touch fitted and must occur over studs on the framing side. Where sheet end joints are unavoidable they must be over nogs and the outer layer joints offset from those on the inner layer.

ACOUSTIC SEALANT

A bead of GIB Soundseal® acoustic sealant is required around the perimeter of the inner lining. The outer lining is then bedded onto the bead.

FASTENING THE LINING

Fasteners

Framing side

Inner layer: 25mm x 6g GIB® Grabber® Self Tapping Drywall Screws.

Outer layer: 32mm x 6g GIB® Grabber® Self Tapping Drywall Screws.

GIB Rail® side

Inner layer: 25mm x 6g GIB® Grabber® Self Tapping Drywall Screws.

Outer layer: 32mm x 6g GIB® Grabber® Self Tapping Drywall Screws.

Fastener centres

Fixings at 300mm centres to each stud and along each rail.

Place fasteners 12mm from sheet edges generally and 50mm from sheet ends.

Warning: Systems that utilise GIB Rail® require particular attention to ensure the sheet fasteners do not compromise acoustic performance. When fastening the lining through the GIB Rail®, set the screws to the side of the studs. The screws must not touch or penetrate the framing. Marking the position of the studs on the floor will help to avoid screwing into the studs.

JOINTING

Inner layer: Unstopped.

Outer layer: All fastener heads stopped and all sheet joints tape reinforced and stopped in accordance with the publication entitled GIB® Site Guide. Wall to ceiling junctions are to be reinforced with paper tape and square stopped or finished with GIB-Cove®.

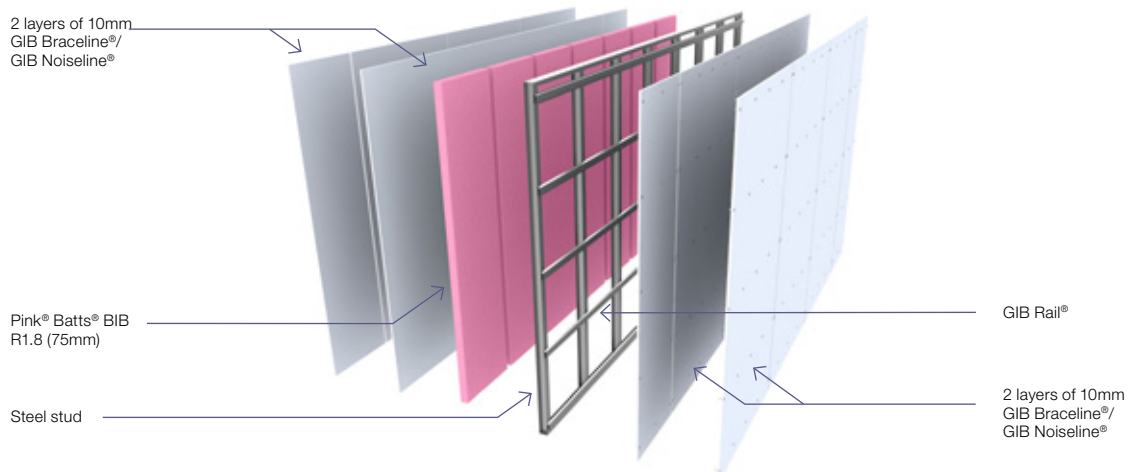

Two way FRR — steel frame wall — GIB Rail®

Specification number	Performance	Specifications
GBSA 90r	STC 57	Lining 2 x 13mm GIB Fyreline® each side
	Rw 56	LB/NLB Non load bearing
	FRR -/90/90	Partition 129mm wide

FRAMING

Stud size	Space between frames
64 x 34 x 0.50mm	N/A

Steel stud dimensions 64 x 34 x 0.50mm BMT with 6mm return placed in 64 x 30 x 0.50mm BMT steel channel. Channel is fixed to floor and ceiling. Studs are friction fitted at 600mm centres maximum with a 15mm expansion gap at the top of the frame. No fixings to the top channel.

WALL HEIGHTS

Recommended maximum wall height is 2700mm. For greater wall heights refer to steel stud centres and wall heights section on pages 14–15 of this publication.

SOUND CONTROL INFILL

Pink® Batts® BIB R1.8 (75mm) glass wool insulation installed between the studs.

FASTENING THE GIB RAIL®

The rail shall be fixed horizontally at 600mm centres using 32mm x 8g GIB® Grabber® Wafer Head Self Tapping Screws through the base flange into each stud. The base flange shall point downwards and the open edge upwards.

The top rail shall be fastened with its upper edge below the top channel but no more than 75mm below the ceiling line. The bottom rail 50mm from the floor line. The bottom rail only may be fixed with its base flange up or down for ease of attachment. Splice rails directly over the studs by nestling (not butting) with no more than a 20mm overlap. Drive the fastener through both flanges into the stud.

WALL LINING

2 layers of 13mm GIB Fyreline® fixed vertically each side of the frame.

Vertical joints of the outer layer are offset 600mm from those of the inner layer. Use full height sheets where possible. Sheet joints are

touch fitted and must occur over studs on the framing side. Where sheet end joints are unavoidable they must be over nogs and the outer layer offset from those on the inner layer.

ACOUSTIC SEALANT

A bead of GIB Soundseal® acoustic sealant is required around the perimeter of the inner lining. The outer lining is then bedded onto the bead.

FASTENING THE LINING

Fasteners

Framing side

Inner layer: 25mm x 6g GIB® Grabber® Self Tapping Drywall Screws.

Outer layer: 41mm x 6g GIB® Grabber® Self Tapping Drywall Screws.

GIB Rail® side

Inner layer: 25mm x 6g GIB® Grabber® Self Tapping Drywall Screws.

Outer layer: 41mm x 6g GIB® Grabber® Self Tapping Drywall Screws.

Fastener centres

Fixings at 300mm centres to each stud and along each rail.

Place fasteners 12mm from sheet edges generally and 50mm from sheet ends.

Warning: Systems that utilise GIB Rail® require particular attention to ensure the sheet fasteners do not compromise acoustic performance. When fastening the lining through the GIB Rail®, set the screws to the side of the studs. The screws must not touch or penetrate the framing. Marking the position of the studs on the floor will help to avoid screwing into the studs.

JOINTING

Inner layer: Unstopped.

Outer layer: All fastener heads stopped and all sheet joints tape reinforced and stopped in accordance with the publication entitled GIB® Site Guide. Wall to ceiling junctions are to be reinforced with paper tape and square stopped or finished with GIB-Cove®.

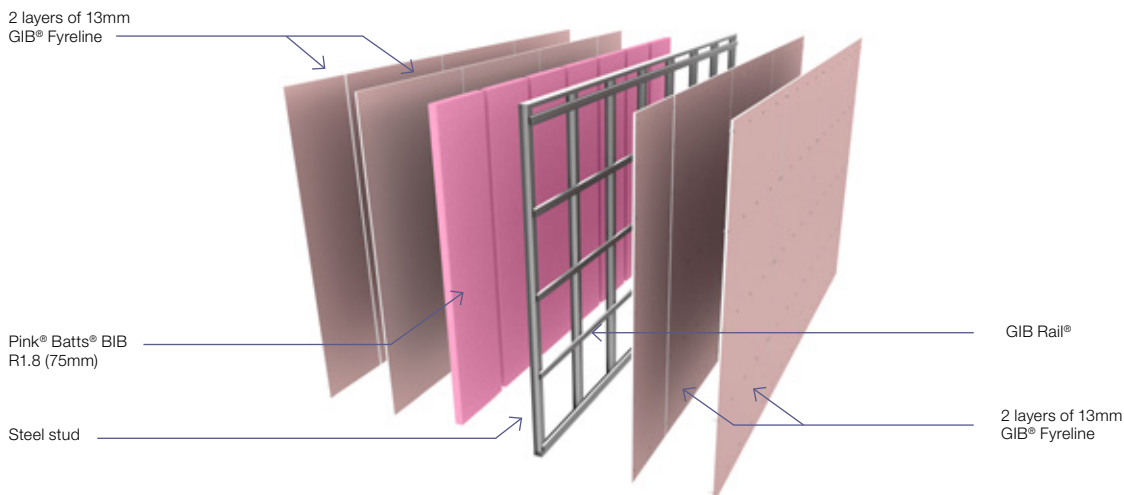

Two way FRR — steel frame wall — acoustic resilient mount

Specification number	Performance	Specifications
GBSIC 45a	STC 55	Lining 2 x 13mm GIB® Standard Plasterboard each side
	Rw 54	LB/NLB Non load bearing
	FRR -/45/45	Partition 155–160mm wide

FRAMING

Stud size	Space between frames
64 x 34 x 0.50mm	N/A

Steel stud dimensions 64 x 34 x 0.50mm BMT with 6mm return placed in 64 x 30 x 0.50mm BMT steel channel. Channel is fixed to floor and ceiling. Studs are friction fitted at 600mm centres maximum with 15mm expansion gap at the top of the frame. No fixings to the top channel.

WALL HEIGHTS

Recommended maximum wall height is 2700mm. For greater wall heights refer to the steel stud centres and wall heights section on pages 14–15 of this publication.

SOUND CONTROL INFILL

Pink® Batts® BIB R1.8 (75mm) glass wool insulation installed between the studs.

ACOUSTIC RESILIENT MOUNT (ST-001)

The ST-001 clip is placed at 600mm centres vertically and fixed every second stud using a single 51mm x 7g GIB® Grabber® Self Tapping Drywall Screw. When adjusting the clip for depth, 3mm of rubber must remain between the underside of the steel spacerhead and furring channel.

The furring channels must be either USG FC37 or Rondo® 308. Furring channels are clipped horizontally into the ST-001 clips. Joints must be made as close as possible to the ST-001 clips.

WALL LINING

2 layers of 13mm GIB® Standard Plasterboard fixed vertically each side of the frame.

Vertical joints of the outer layer are offset 600mm from those of the inner layer. Use full height sheets where possible. Sheet joints are touch fitted and must occur over studs on the framing side. Where sheet end joints are unavoidable they must be over nogs and the outer layer joints offset from those on the inner layer.

ACOUSTIC SEALANT

A bead of GIB Soundseal® acoustic sealant is required around the perimeter of the inner frame or lining. The outer lining is then bedded onto the bead.

FASTENING THE LINING

Fasteners

Furring channel side

Inner layer: 25mm x 6g GIB® Grabber® Self Tapping Drywall Screws.

Outer layer: 41mm x 6g GIB® Grabber® Self Tapping Drywall Screws.

Framing side

Inner layer: 25mm x 6g GIB® Grabber® Self Tapping Drywall Screws.

Outer layer: 41mm x 6g GIB® Grabber® Self Tapping Drywall Screws.

Fastener centres

Fixings at 300mm centres to each stud and along the furring channel. Place fasteners 12mm from sheet edges.

JOINTING

Inner layer: Unstopped.

Outer layer: All fastener heads stopped and all sheet joints tape reinforced and stopped in accordance with the publication entitled GIB® Site Guide. Wall to ceiling junctions are to be reinforced with paper tape and square stopped or finished with GIB-Cove®.

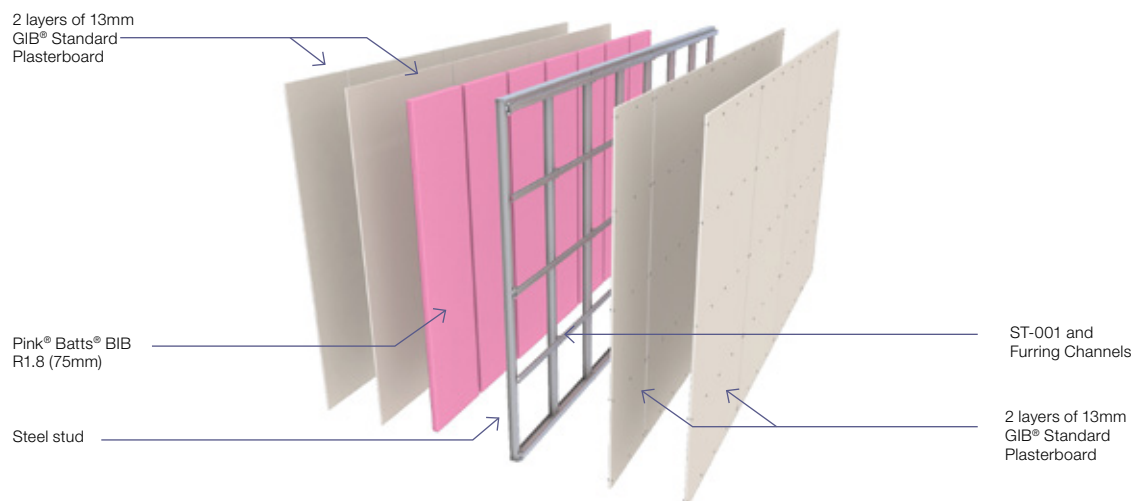

Two way FRR — steel frame wall — staggered stud

Specification number	Performance	Specifications
GBSA 30s	STC 55	Lining 1 x 13mm GIB® Standard Plasterboard one side 2 x 13mm GIB® Standard Plasterboard other side
	Rw 53	
	FRR -/30/30	LB/NLB Non load bearing
		Partition 131mm wide

FRAMING

Stud size	Space between frames
64 x 34 x 0.50mm	N/A

Steel stud dimensions 64 x 30 x 0.50mm BMT with 6mm return placed in 92 x 30 x 0.50mm BMT steel channel.

Channel is fixed to floor and ceiling, and studs placed staggered at 300mm centres to form 600mm centres maximum at each side of the channel. Studs are placed to allow a 15mm expansion gap at the top of the frame. Rondo® staggered stud clips are used top and bottom of studs to friction fit studs to channel. No other fixings to channels are allowed.

WALL HEIGHTS

Recommended maximum wall height is 2400mm. For greater wall heights refer to the steel stud centres and wall heights section on pages 14–15 of this publication.

SOUND CONTROL INFILL

Pink® Batts® BIB R1.8 (75mm) glass wool insulation installed between the studs. 600mm wide batts require splitting to 300mm.

WALL LINING

1 layer of 13mm GIB® Standard Plasterboard one side and 2 layers 13mm GIB® Standard Plasterboard on the other side.

All layers fixed vertically. Vertical joints of the outer layer are offset 600mm from those of the inner layer. The inner layers must be

fitted hard to floor. Use full height sheets where possible. Where sheet end joints are unavoidable they must be over nogs and outer layer joints offset from the inner. Sheet joints are touch fitted and must occur over framing.

ACOUSTIC SEALANT

A bead of GIB Soundseal® acoustic sealant is required around the perimeter of the inner lining. The outer lining is then bedded onto the bead. On the single layer side the sealant is placed around the frame.

FASTENING THE LINING

Fasteners

Inner or single layer: 25mm x 6g GIB® Grabber® Self Tapping Drywall Screws.

Outer layer: 41mm x 6g GIB® Grabber® Self Tapping Drywall Screws.

Fastener centres

Inner and outer layer: 300mm centres up each stud.

Place fasteners 12mm from sheet edges generally and 50mm from sheet ends.

JOINTING

Inner layer: Unstopped.

Outer layer: All fastener heads stopped and all sheet joints tape reinforced and stopped in accordance with the publication entitled GIB® Site Guide. Wall to ceiling junctions are to be reinforced with paper tape and square stopped or finished with GIB-Cove®.

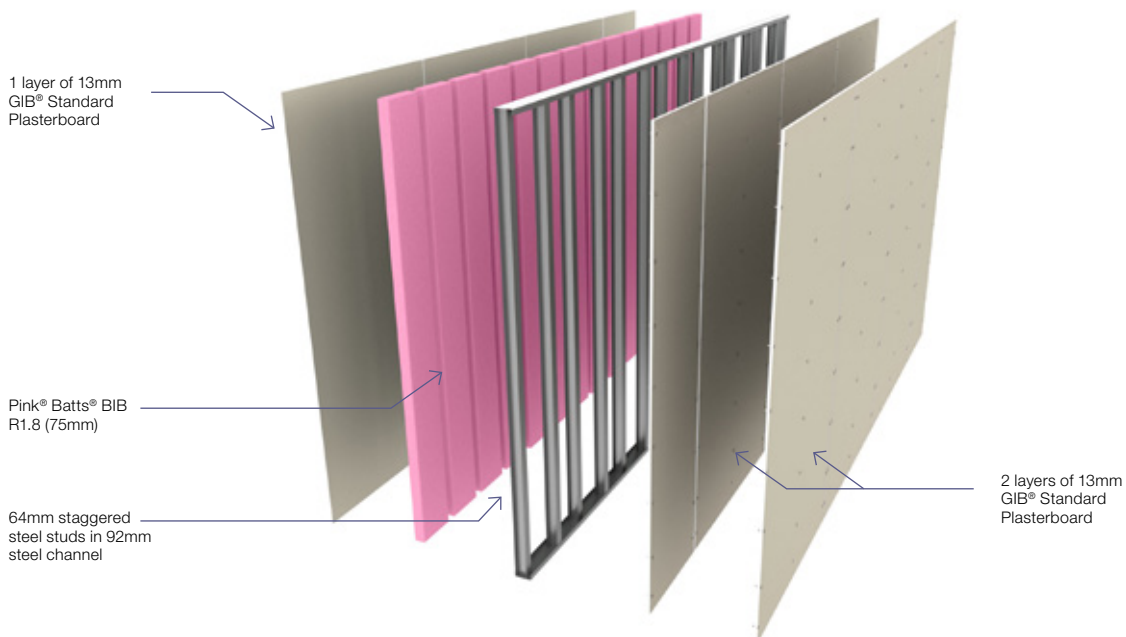

Two way FRR — steel frame wall — staggered stud

Specification number	Performance	Specifications
GBSA 90s	STC 60	Lining 1 x 13mm GIB Braceline®/GIB Noiseline® and 1 x 10mm GIB Braceline®/GIB Noiseline® each side
	Rw 58	
	FRR -/90/90	LB/NLB Non load bearing
		Partition 138mm wide

FRAMING

Stud size	Space between frames
64 x 34 x 0.50mm	N/A

Steel stud dimensions 64 x 30 x 0.50mm BMT with 6mm return placed in 92 x 30 x 0.50mm BMT steel channel.

Channel is fixed to floor and ceiling, and studs placed staggered at 300mm centres to form 600mm centres maximum at each side of the channel. Studs are placed to allow a 15mm expansion gap at the top of the frame. Rondo® staggered stud clips are used top and bottom of studs to friction fit studs to channel. No other fixings to channels are allowed.

WALL HEIGHTS

Recommended maximum wall height is 2400mm. For greater wall heights refer to the steel stud centres and wall heights section on pages 14–15 of this publication.

SOUND CONTROL INFILL

Pink® Batts® BIB R1.8 (75mm) glass wool insulation installed between the studs. 600mm wide batts require splitting to 300mm.

WALL LINING

1 layer of 13mm GIB Braceline®/GIB Noiseline® and 1 layer of 10mm GIB Braceline®/GIB Noiseline® on each side.

All layers fixed vertically. Vertical joints of the outer layer are offset 600mm from those of the inner layer. The inner layers must be fitted

hard to floor. Use full height sheets where possible. Where sheet end joints are unavoidable they must be over nogs and outer layer joints offset from the inner. Sheet joints are touch fitted and must occur over framing.

ACOUSTIC SEALANT

A bead of GIB Soundseal® acoustic sealant is required around the perimeter of the inner lining. The outer lining is then bedded onto the bead.

FASTENING THE LINING

Fasteners

Inner layer: 25mm x 6g GIB® Grabber® Self Tapping Drywall Screws.

Outer layer: 41mm x 6g GIB® Grabber® Self Tapping Drywall Screws.

Fastener centres

Inner and outer layer: 300mm centres up each stud.

Place fasteners 12mm from sheet edges generally and 50mm from sheet ends.

JOINTING

Inner layer: Unstopped.

Outer layer: All fastener heads stopped and all sheet joints tape reinforced and stopped in accordance with the publication entitled GIB® Site Guide. Wall to ceiling junctions are to be reinforced with paper tape and square stopped or finished with GIB-Cove®.

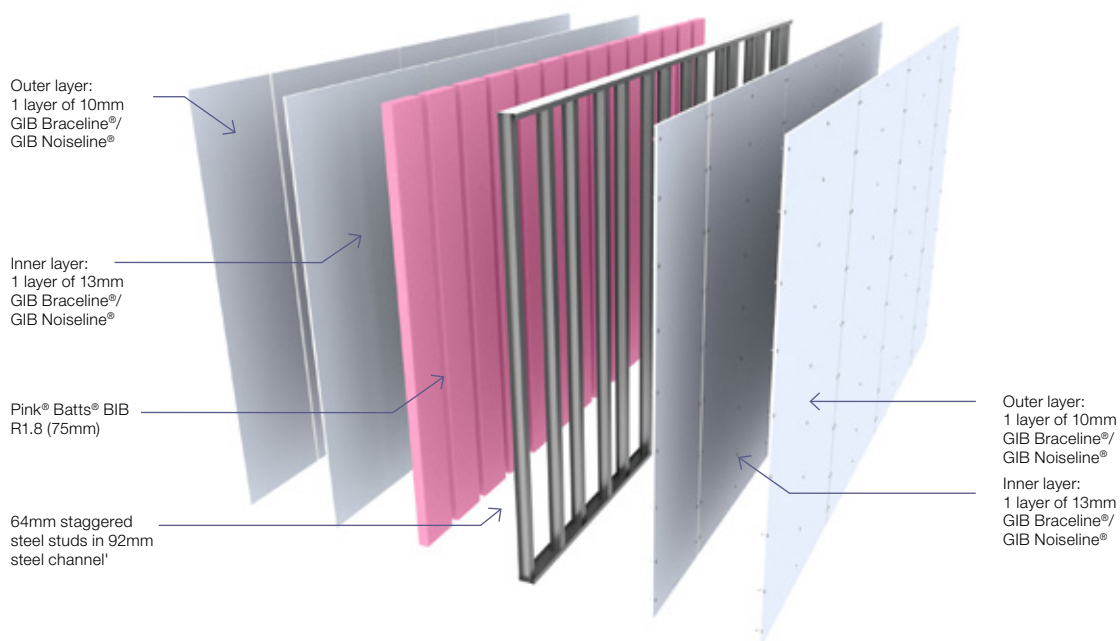

Two way FRR — steel frame wall — GIB® Rondo® Quiet Stud®

Specification number	Performance	Specifications
GBQSA 45	STC 56	Lining 2 x 13mm GIB® Standard Plasterboard each side
	Rw 56	LB/NLB Non load bearing
	FRR -/45/45	Partition 144mm wide

FRAMING

Stud size	Space between frames
92 x 45 x 0.55mm	N/A

GIB® Rondo® Quiet Stud® resilient steel stud 92 x 45 x 0.55mm BMT and placed in 92 x 30 x 0.55mm BMT steel channel. Channel is fixed to floor and ceiling. Studs are friction fitted at 600mm centres maximum with a 15mm expansion gap at the top of the frame. No fixings to the top channel.

WALL HEIGHTS

Recommended maximum wall height is 3800mm. For greater wall heights refer to the steel stud centres and wall heights section on pages 14–15 of this publication.

SOUND CONTROL INFILL

Pink® Batts® R2.2 (90mm) glass wool insulation installed between the studs.

WALL LINING

2 layers of 13mm GIB® Standard Plasterboard fixed vertically each side of the frame.

Vertical joints of the outer layer are offset 600mm from those of the inner layer. The inner layers must be fitted hard to floor. Use full height sheets where possible. Sheet joints are touch fitted and must occur over framing. Where sheet end joints are unavoidable they must be over nogs and outer layer joints offset from those on the inner layer.

ACOUSTIC SEALANT

A bead of GIB Soundseal® acoustic sealant is required around the perimeter of the inner lining. The outer lining is then bedded onto the bead.

FASTENING THE LINING

Fasteners

Inner layer: 25mm x 6g GIB® Grabber® Self Tapping Drywall Screws.

Outer layer: 41mm x 6g GIB® Grabber® Self Tapping Drywall Screws.

Fastener centres

Inner and outer layer: 300mm centres up each stud.

Place fasteners 12mm from sheet edges generally and 50mm from sheet ends.

JOINTING

Inner layer: Unstopped.

Outer layer: All fastener heads stopped and all sheet joints tape reinforced and stopped in accordance with the publication entitled GIB® Site Guide. Wall to ceiling junctions are to be reinforced with paper tape and square stopped or finished with GIB-Cove®.

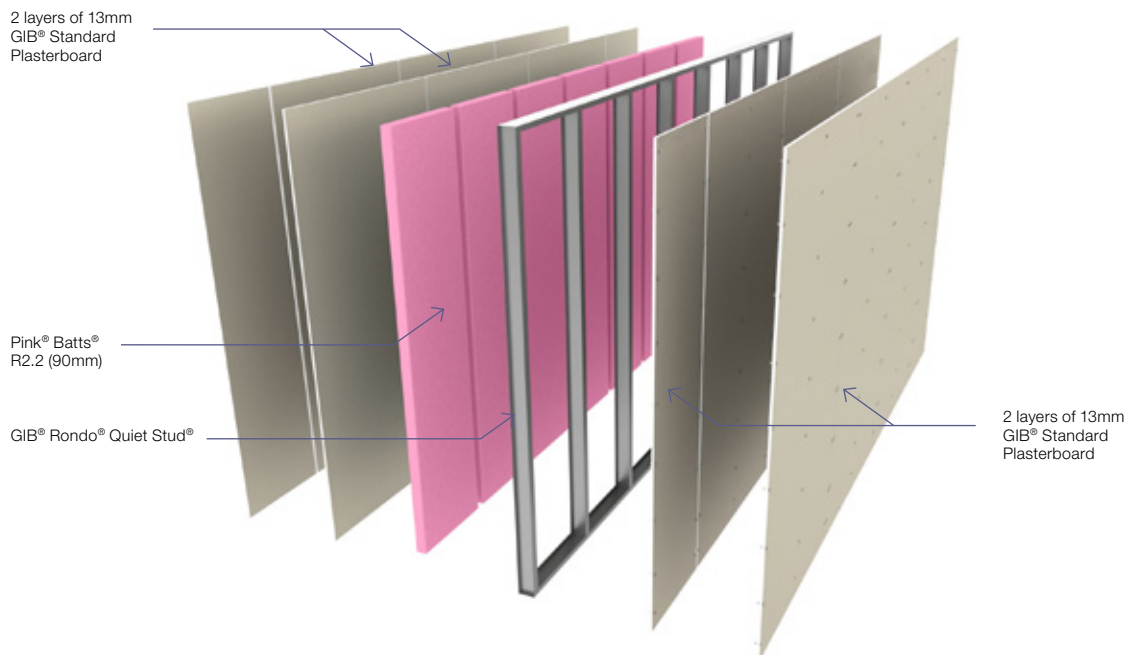

Two way FRR — steel frame wall — GIB® Rondo® Quiet Stud®

Specification number	Performance	Specifications
GBQSA 60a	STC 55 Rw 55 FRR -/60/60	Lining 1 x 13mm and 1 x 10mm GIB Braceline®/GIB Noiseline® one side 1 x 13mm GIB Braceline®/GIB Noiseline® on other side LB/NLB Non load bearing Partition 128mm wide

FRAMING

Stud size	Space between frames
92 x 45 x 0.55mm	N/A

GIB® Rondo® Quiet Stud® resilient steel stud 92 x 45 x 0.55mm BMT and placed in 92 x 30 x 0.55mm BMT steel channel. Channel is fixed to floor and ceiling. Studs are friction fitted at 600mm centres maximum with a 15mm expansion gap at the top of the frame. No fixings to the top channel.

WALL HEIGHTS

Recommended maximum wall height is 3800mm. For greater wall heights refer to the steel stud centres and wall heights section on pages 14–15 of this publication.

SOUND CONTROL INFILL

Pink® Batts® R2.2 (90mm) glass wool insulation installed between the studs.

WALL LINING

1 layer of 13mm GIB Braceline®/GIB Noiseline® and 1 layer of 10mm GIB Braceline®/GIB Noiseline® one side and 1 layer of 13mm GIB Braceline®/GIB Noiseline® other side fixed vertically to the frame.

Inner layer joints on opposite sides of the frame are offset. Vertical joints of the outer layer are offset 600mm from those of the inner

layer. The inner layers must be fitted hard to floor. Use full height sheets where possible. Sheet joints are touch fitted and must occur over framing. Where sheet end joints are unavoidable they must be over nogs and outer layer joints offset from those on the inner layer.

ACOUSTIC SEALANT

A bead of GIB Soundseal® acoustic sealant is required around the perimeter of the inner lining. The outer lining is then bedded onto the bead.

FASTENING THE LINING

Fasteners

Inner layer: 25mm x 6g GIB® Grabber® Self Tapping Drywall Screws.

Outer layer: 41mm x 6g GIB® Grabber® Self Tapping Drywall Screws.

Fastener centres

Inner and outer layer: 300mm centres up each stud.

Place fasteners 12mm from sheet edges generally and 50mm from sheet ends.

JOINTING

Inner layer: Unstopped.

Outer layer: All fastener heads stopped and all sheet joints tape reinforced and stopped in accordance with the publication entitled GIB® Site Guide. Wall to ceiling junctions are to be reinforced with paper tape and square stopped or finished with GIB-Cove®.

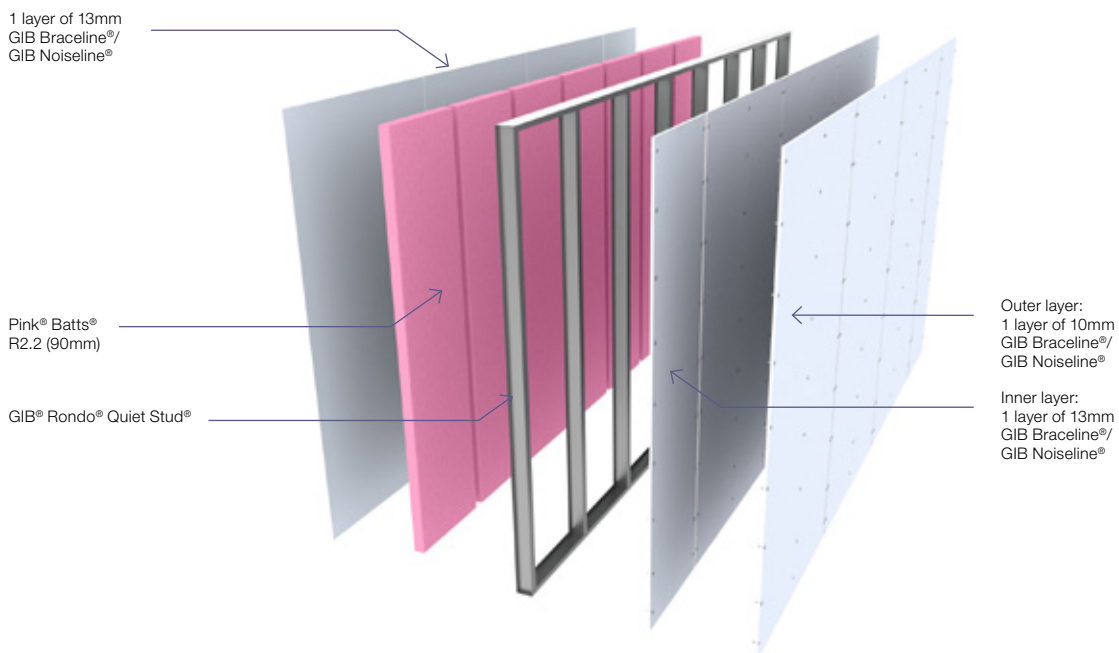

Two way FRR — steel frame wall — GIB® Rondo® Quiet Stud®

Specification number	Performance	Specifications
GBQSA 90	STC 58	Lining 1 x 13mm and 1 x 10mm GIB Braceline®/GIB Noiseline® each side LB/NLB Non load bearing Partition 138mm wide
	Rw 59	
	FRR -/90/90	

FRAMING

Stud size	Space between frames
92 x 45 x 0.55mm	N/A

GIB® Rondo® Quiet Stud® resilient steel stud 92 x 45 x 0.55mm BMT and placed in 92 x 30 x 0.55mm BMT steel channel. Channel is fixed to floor and ceiling. Studs are friction fitted at 600mm centres maximum with a 15mm expansion gap at the top of the frame. No fixings to the top channel.

WALL HEIGHTS

Recommended maximum wall height is 3800mm. For greater wall heights refer to the steel stud centres and wall heights section on pages 14–15 of this publication.

SOUND CONTROL INFILL

Pink® Batts® R2.2 (90mm) glass wool insulation installed between the studs.

WALL LINING

1 layer of 13mm and 1 layer of 10mm GIB Braceline®/GIB Noiseline® fixed vertically each side of the frame.

Inner layer joints on opposite sides of the frame are offset. Vertical joints of the outer layer are offset 600mm from those of the inner layer. The inner layers must be fitted hard to floor. Use full height

sheets where possible. Sheet joints are touch fitted and must occur over framing. Where sheet end joints are unavoidable they must be over nogs and outer layer joints offset from those on the inner layer.

ACOUSTIC SEALANT

A bead of GIB Soundseal® acoustic sealant is required around the perimeter of the inner lining. The outer lining is then bedded onto the bead.

FASTENING THE LINING

Fasteners

Inner layer: 25mm x 6g GIB® Grabber® Self Tapping Drywall Screws.

Outer layer: 41mm x 6g GIB® Grabber® Self Tapping Drywall Screws.

Fastener centres

Inner and outer layer: 300mm centres up each stud.

Place fasteners 12mm from sheet edges generally and 50mm from sheet ends.

JOINTING

Inner layer: Unstopped.

Outer layer: All fastener heads stopped and all sheet joints tape reinforced and stopped in accordance with the publication entitled GIB® Site Guide. Wall to ceiling junctions are to be reinforced with paper tape and square stopped or finished with GIB-Cove®.

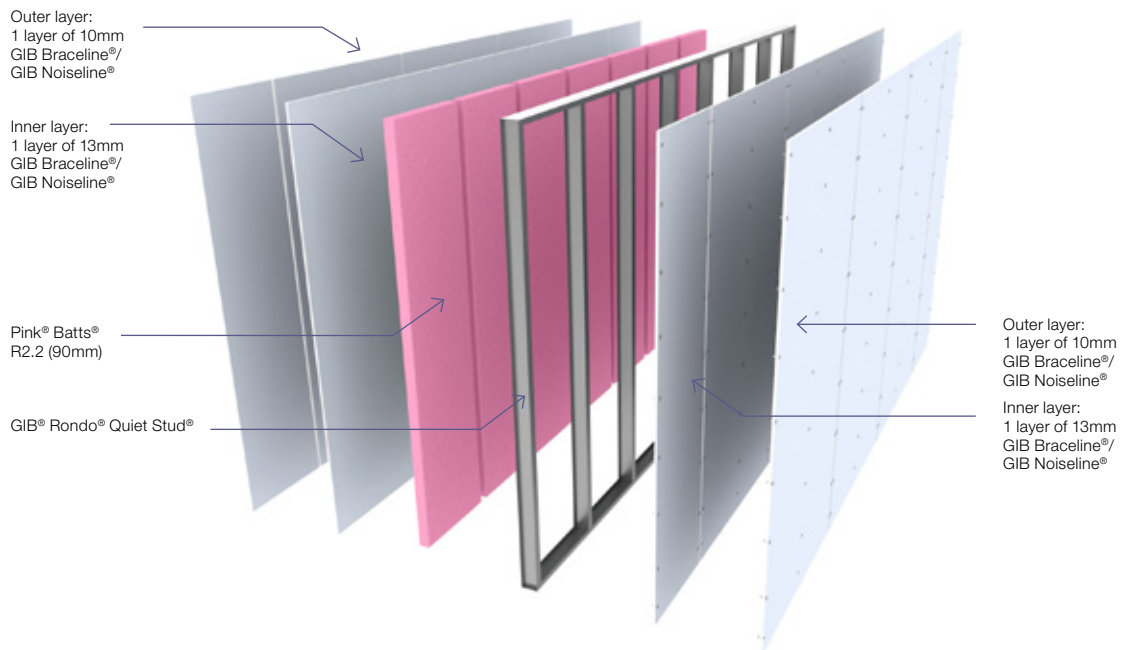

Floor/ceiling — timber joists

Specification number	Performance	Specifications
GBDFA 60b	STC 57	Lining 2 x 13mm GIB Fyreline®
	Rw 56	LB/NLB Load bearing
	FRR 60/60/60	IIC* 47–69

FLOOR FRAMING

Floor joists shall comply with NZS 3604. Joists shall be spaced at 600mm centres maximum and shall have a depth of 190mm minimum.

Alternative floor framing

Use either Hyspan® or Hybeam® HJ series joists designed for strength and serviceability, no less than 190mm deep and spaced at no more than 600mm. Consult the joist manufacturer regarding construction of the solid blocking contained in the floor/ceiling to wall junctions.

FLOORING

Flooring shall be nominal 20mm particle board or 20mm oriented strand board or minimum 17mm thick structural plywood fixed to the joists in accordance with the manufacturer's specifications. Flooring sheet joints must have a tongue and groove jointer, or be formed over framing.

If 17mm thick structural plywood is selected as the flooring material, one of the following floor coverings must be installed to achieve the listed STC and Rw performance:

- 4mm cushion-back vinyl; or,
- Wooden strip flooring; or,
- Ceramic tile; or,
- 40oz cut pile carpet loose laid on 8mm foam underlay.

CEILING BATTEN AND DIRECT FIX CLIP SYSTEM

The clips shall be fastened to the joists at 1200mm centres maximum (and no less than 900mm centres) to support the GIB® Rondo® metal ceiling batten system. Fasten each clip to the joist with 3 x 32mm x 8g GIB® Grabber® Self Tapping Wafer Head Screws. The battens shall be spaced at 600mm centres maximum.

SOUND CONTROL INFILL

Ceiling overlaid with Pink® Batts® BIB R1.8 (75mm) glass wool insulation.

CEILING LINING

2 layers of 13mm GIB Fyreline® fixed at right angles to the steel battens.

Offset the joints of the outer layer by 600mm from those of the inner layer. All sheet end butt joints shall occur on the battens and are offset between the first and second layers. Sheet joints are touch fitted.

FASTENING THE LINING

Fasteners

Inner layer: 32mm x 6g GIB® Grabber® Self Tapping Drywall Screws.

Outer layer: 41mm x 6g GIB® Grabber® Self Tapping Drywall Screws.

Fastener centres (both layers)

200mm centres along each batten and at 100mm centres along sheet end butt joints. Place fasteners no closer than 12mm to the sheet edges.

ACOUSTIC SEALANT

A bead of GIB Soundseal® acoustic sealant is required on the inner lining around the ceiling perimeter. The outer lining is then bedded onto the bead.

WALL/CEILING JUNCTIONS

The internal angle between the ceiling and walls are finished with GIB-Cove® adhered with GIB-Cove® Bond, or boxed corners (square stopped) filled and taped in accordance with the publication entitled GIB® Site Guide.

JOINTING

Inner layer: Unstopped.

Outer layer: All fastener heads stopped and all sheet joints tape reinforced and stopped in accordance with the publication entitled GIB® Site Guide.

*Impact Insulation Class (IIC)

A performance of IIC 47 is achieved by a bare floor.

A performance of IIC 50 is achieved with a floor covering of 4mm cushion-backed vinyl.

A performance of IIC 69 is achieved with a floor covering of 40oz cut pile carpet loose laid on 8mm foam underlay.

Note: See page 90 for perimeter details.

Floor/ceiling — timber joists

Specification number	Performance	Specifications
GBDFA 60b	STC 57 Rw 56 FRR 60/60/60	Lining 2 x 13mm GIB Fyreline® LB/NLB Load bearing IIC* 47–69

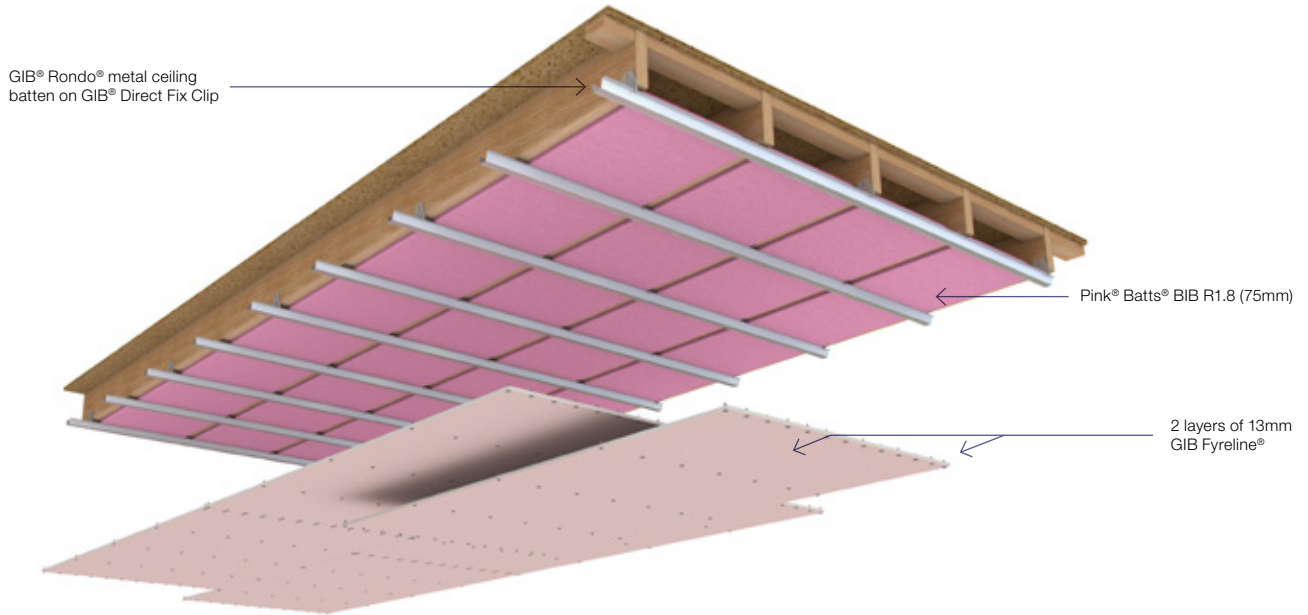

Floor/ceiling — timber joists

Specification number	Performance	Specifications
GBDFA 60d	STC 67 Rw 65 FRR 60/60/60	Lining 2 x 13mm GIB Fyreline® LB/NLB Load bearing IIC* 57–76

FLOOR FRAMING

Floor joists shall comply with NZS 3604, be spaced at 450mm centres maximum and have a depth of 190mm minimum.

ALTERNATIVE FLOOR FRAMING

Use either Hyspan® or Hybeam® HJ series joists designed for serviceability, no less than 200mm deep and spaced at no more than 450mm. Consult the joist manufacturer regarding construction of the solid blocking contained in the floor/ceiling to wall junctions.

FLOORING

James Hardie Secura Interior Flooring fixed at right angles to the timber floor joists. Sheet edges other than tongue and groove must be supported by floor joists. Sheets must be laid in a staggered pattern. The minimum length for a cut sheet is 900mm. Apply a 6mm continuous bead of adhesive to joists prior to installation of sheets.

FASTENING THE FLOORING

Adhesive

- Bostik Seal 'n' Flex 1; or,
- Sika Sikaflex 11FC; or,
- Holdfast 220LM.

Fasteners

- 40mm x 10g wood thread self embedding screws; or,
- 50 x 2.87mm stainless steel ring RounDrive nails; or,
- 50 x 2.87mm Dekfast HD galvanised RounDrive nails.

Fastener Centres (both layers)

200mm centres along each joist. Place fasteners no closer than 25mm to longitudinal sheet edges and 12mm from transverse sheet edges. Place fasteners no closer than 50mm to sheet corners.

FLOATING FLOOR AND FLOORING VOID SOUND CONTROL INFILL

Space the James Hardie Acoustic Cradles at 450mm maximum centres on the bottom layer of James Hardie Secura Interior Flooring. The James Hardie Acoustic Cradles do not need to be aligned with the timber floor joists and are not to be fixed down to the bottom layer of James Hardie Secura Interior Flooring.

Lay Pink® Batts® R1.2 (50mm) glass wool insulation between the James Hardie Acoustic Channels.

Place 50mm thick sound control infill between James Hardie Acoustic Channels. Minimum density 9.6 kg/m³. A suitable product is Pink® Batts® R1.2 (50mm) glass wool insulation.

James Hardie Secura Interior Flooring fixed at right angles to the James Hardie Acoustic Channels. Sheet edges other than tongue and groove must be supported by channels. Sheets must be laid in a staggered pattern. The minimum length for a cut sheet is 900mm. Ensure the sheets are laid the correct way down depending on the final finish i.e. tiles or vinyl. Apply a 6mm continuous bead of adhesive to joists prior to installation of sheets.

Allow a 5mm minimum gap where sheet edges butt into external/internal walls. Fill gap with GIB Soundseal® acoustic sealant.

In designated wet areas there is a need to seal the sheet joints and apply a waterproof membrane. If tiles are to be applied as a final finish there may be a requirement to form one or more control joints.

GIB QUIET CLIP® AND BATTENS

The GIB Quiet Clip® shall be fastened to the joists at maximum 1200mm centres (and no less than 900mm centres) to support the GIB® Rondo® metal ceiling battens.

INSTALLING THE GIB QUIET CLIP®

Use 3 x 32mm x 8g GIB® Grabber® Self Tapping Wafer Head Screws. Insert the first screw into the middle rubber grommet, tighten enough to hold the GIB Quiet Clip® in place, adjust the clip to the correct height, insert the remaining two screws and tighten. Do not overtighten the screws to the point where the grommet is crushed. The screws should be tightened enough to allow the flexibility to remain in the connection between the grommet and the timber joists.

CEILING VOID SOUND CONTROL INFILL

Ceiling overlaid with Pink® Batts® BIB (75mm) glass wool insulation.

CEILING LINING

2 layers of 13mm GIB Fyreline® fixed at right angles to the steel battens.

Offset the joints of the outer layer by 600mm from those of the inner layer. All sheet end butt joints shall occur on the battens and are offset between the first and second layers. Sheet joints are touch fitted.

FASTENING THE LINING

Fasteners

Inner layer: 32mm x 6g GIB® Grabber® Self Tapping Drywall Screws.

Outer layer: 41mm x 6g GIB® Grabber® Self Tapping Drywall Screws.

Fastener centres (both layers)

200mm centres along each batten and at 100mm centres along sheet end butt joints. Place fasteners no closer than 12mm to the sheet edges.

ACOUSTIC SEALANT

A bead of GIB Soundseal® acoustic sealant is required around the ceiling perimeter.

WALL/CEILING JUNCTIONS

The internal angle between ceiling and walls must be protected by GIB-Cove® adhered with GIB-Cove® Bond, or boxed corners (square stopped) filled and taped in accordance with the publication entitled GIB® Site Guide.

Floor/ceiling — timber joists

Specification number	Performance	Specifications
GBDFA 60d	STC 67	Lining 2 x 13mm GIB Fyreline®
	Rw 65	LB/NLB Load bearing
	FRR 60/60/60	IIC* 57–76

JOINTING

All fastener heads stopped and all sheet joints tape reinforced and stopped in accordance with the publication entitled GIB® Site Guide.

SUPPLEMENTARY MATERIAL

For additional information covering general and wet area installations of James Hardie Secura Interior Flooring, refer to the James Hardie Secura Interior Flooring Installation Manual.

*Impact Insulation Class (IIC)

A performance of IIC 57 is achieved with a bare floor.

A performance of IIC 57 is achieved with a floor covering of 4mm cushion-backed vinyl.

A performance of IIC 76 is achieved with a floor covering of 40oz cut pile carpet loose laid on 8mm foam underlay.

Note: See page 90 for perimeter details.

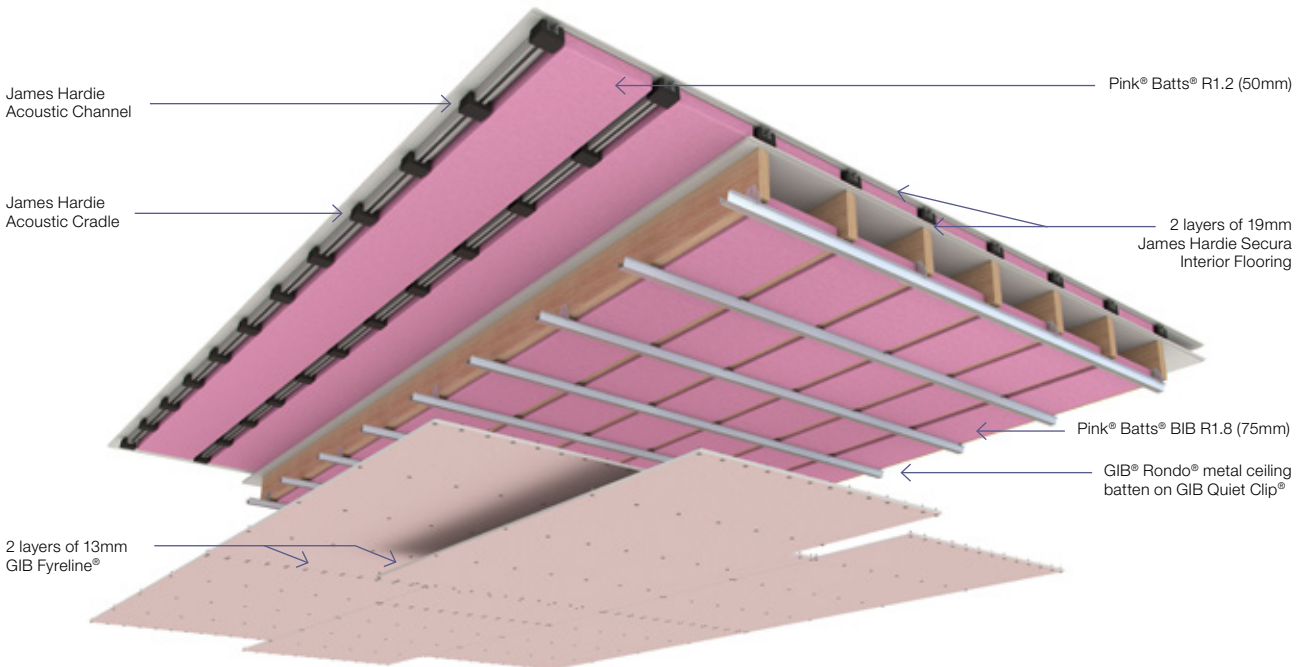

CONSTRUCTION DETAIL

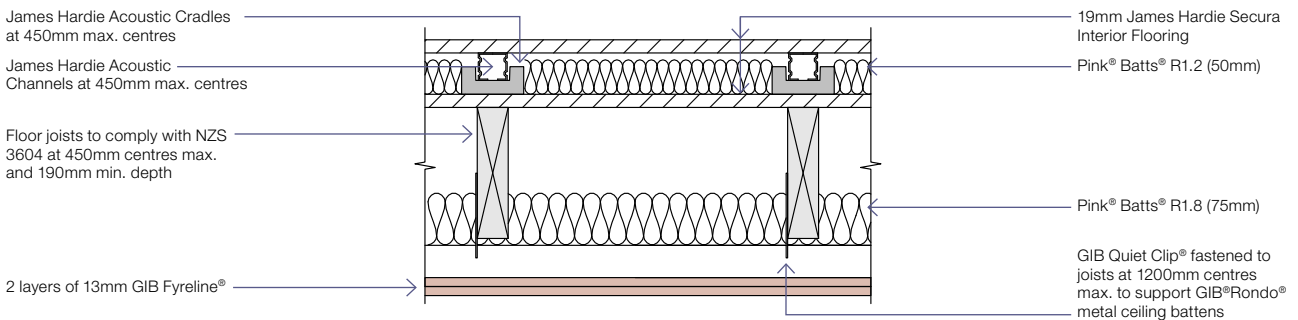

GNS020

Floor/ceiling — timber joists

Specification number	Performance	Specifications
GBDFA 60e	STC 65 Rw 64 FRR 60/60/60	Lining 2 x 13mm GIB Fyreline® LB/NLB Load bearing IIC* 56–72

FLOOR FRAMING

Floor joists shall comply with NZS 3604, be spaced at 600mm centres maximum and have a depth of 190mm minimum.

ALTERNATIVE FLOOR FRAMING

Use either Hyspan® or Hybeam® HJ series joists designed for serviceability, no less than 190mm deep and spaced at no more than 600mm. Consult the joist manufacturer regarding construction of the solid blocking contained in the floor/ceiling to wall junctions.

FLOORING

Laminex Strandfloor® Tongue & Groove or Laminex Strandfloor® H3.1 Tongue & Groove flooring fixed at right angles to the floor joists. Sheet edges other than tongue and groove must be supported by floor joists. No nogging required to support longitudinal sheet joints. Sheets must be laid in a staggered pattern. The minimum length for a cut sheet is 900mm. Apply a 6mm continuous bead of adhesive to joists prior to installation of sheets.

FASTENING THE FLOORING

Adhesive is recommended for use in conjunction with mechanical fastening on both layers.

Adhesive

- Bostik – Alpha Grip; or,
- Sika – Nailbond Premium; or,
- Holdfast – Gorilla Grip; or,
- HB Fuller – Sturdi Bond.

Adhesive shall be applied in a continuous 5mm bead to all floor joists and between sheet ends. A 2mm bead shall be applied along the tongue of the tongue & groove panels as they are laid.

Fasteners

45mm x 8g wood thread self drilling screws (corrosion resistant).

Fastener Centres (both layers)

200mm centres along each joist. Place fasteners no closer than 15mm to longitudinal and transverse sheet edges. Place fasteners no closer than 50mm to sheet corners.

FLOATING FLOOR AND FLOORING VOID SOUND CONTROL INFILL

Space AcoustiFlor™ Acoustic Cradles at 450mm maximum centres on the bottom layer of Laminex Strandfloor® Tongue & Groove flooring. The AcoustiFlor™ Acoustic Cradles do not need to be aligned with the timber floor joists and are not to be fixed down to the bottom layer of Laminex Strandfloor® Tongue & Groove flooring.

Place the Acoustiflor™ Structural Battens in the AcoustiFlor™ Acoustic Cradles. Space AcoustiFlor™ Structural Battens at 400mm maximum centres.

Lay Pink® Batts® R1.2 (50mm) glass wool insulation between the Acoustiflor™ Structural Battens.

Laminex Strandfloor® Tongue & Groove flooring, fixed at right angles to the Acoustiflor™ Structural Battens. Sheet edges other than tongue and groove must be supported by battens. Sheets must be laid in a staggered pattern. The minimum length for a cut sheet is 900mm. Ensure the sheets are laid the correct way down depending on the final finish i.e. tiles or vinyl. Apply a 6mm continuous bead of adhesive to joists prior to installation of sheets.

Allow a 5mm minimum gap where sheet edges butt into external/internal walls. Fill gap with GIB Soundseal® acoustic sealant.

In designated wet areas there is a need to seal the sheet joints and apply a waterproof membrane. If tiles are to be applied as a final finish there may be a requirement to form one or more control joints.

GIB QUIET CLIP® AND BATTENS

The GIB Quiet Clip® shall be fastened to the joists at maximum 1200mm centres (and no less than 900mm centres) to support the GIB® Rondo® metal ceiling battens.

INSTALLING THE GIB QUIET CLIP®

Use 3 x 32mm x 8g GIB® Grabber® Self Tapping Wafer Head Screws. Insert the first screw into the middle rubber grommet, tighten enough to hold the GIB Quiet Clip® in place, adjust the clip to the correct height, insert the remaining two screws and tighten. Do not overtighten the screws to the point where the grommet is crushed. The screws should be tightened enough to allow the flexibility to remain in the connection between the grommet and the timber joists.

CEILING VOID SOUND CONTROL INFILL

Ceiling overlaid with Pink® Batts® BIB (75mm) glass wool insulation.

CEILING LINING

2 layers of 13mm GIB Fyreline® fixed at right angles to the steel battens.

Offset the joints of the outer layer by 600mm from those of the inner layer. All sheet end butt joints shall occur on the battens and are offset between the first and second layers. Sheet joints are touch fitted.

FASTENING THE LINING

Fasteners

Inner layer: 32mm x 6g GIB® Grabber® Self Tapping Drywall Screws.

Outer layer: 41mm x 6g GIB® Grabber® Self Tapping Drywall Screws.

Fastener centres (both layers)

200mm centres along each batten and at 100mm centres along sheet end butt joints. Place fasteners no closer than 12mm to the sheet edges.

Floor/ceiling — timber joists

Specification number	Performance	Specifications
GBDFA 60e	STC 65	Lining 2 x 13mm GIB Fyreline® LB/NLB Load bearing IIC* 56–72
	Rw 64	
	FRR 60/60/60	

ACOUSTIC SEALANT

A bead of GIB Soundseal® acoustic sealant is required around the ceiling perimeter.

WALL/CEILING JUNCTIONS

The internal angle between ceiling and walls must be protected by GIB-Cove® adhered with GIB-Cove® Bond, or boxed corners (square stopped) filled and taped in accordance with the publication entitled GIB® Site Guide.

JOINTING

All fastener heads stopped and all sheet joints tape reinforced and stopped in accordance with the publication entitled GIB® Site Guide.

SUPPLEMENTARY MATERIAL

For additional information covering general and wet area installations of Laminex Strandfloor® Tongue & Groove or Laminex Strandfloor® H3.1 Tongue & Groove flooring, refer to the Laminex Strandfloor® Technical Manual.

*Impact Insulation Class (IIC)

A performance of IIC 56 is achieved with a bare floor.

A performance of IIC 57 is achieved with a floor covering of 4mm cushion-backed vinyl.

A performance of IIC 72 is achieved with a floor covering of 40oz cut pile carpet loose laid on 8mm foam underlay.

Note: See page 90 for perimeter details.

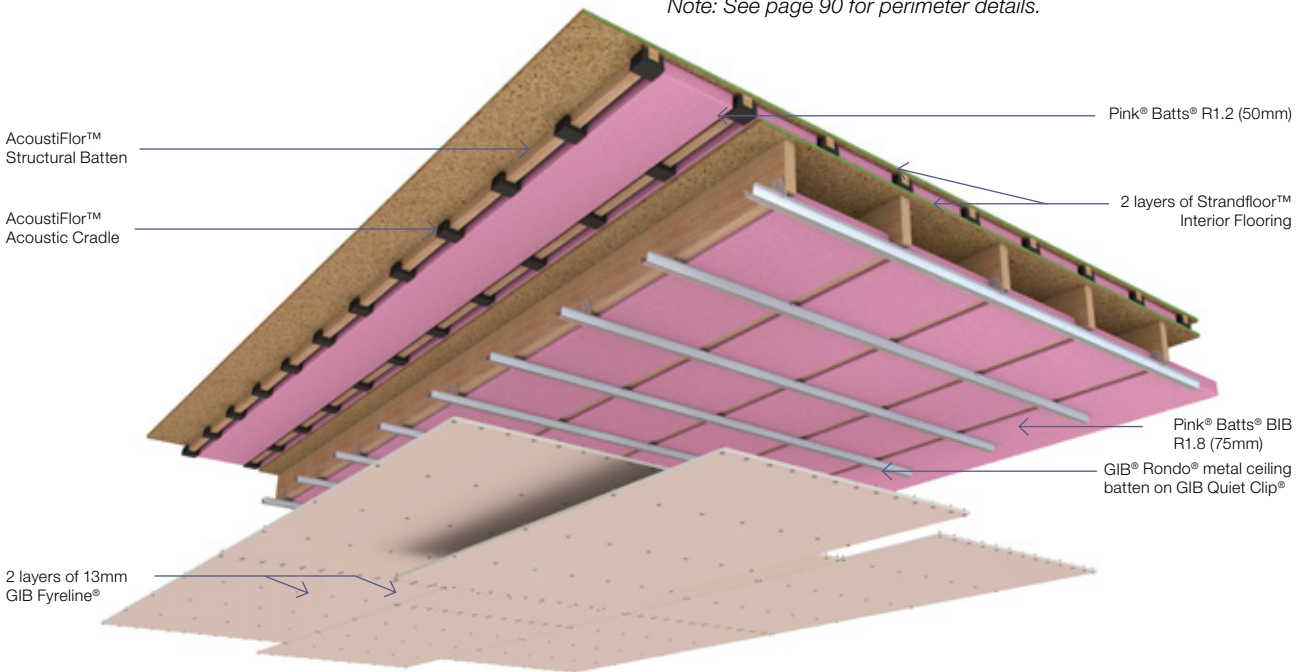

CONSTRUCTION DETAIL

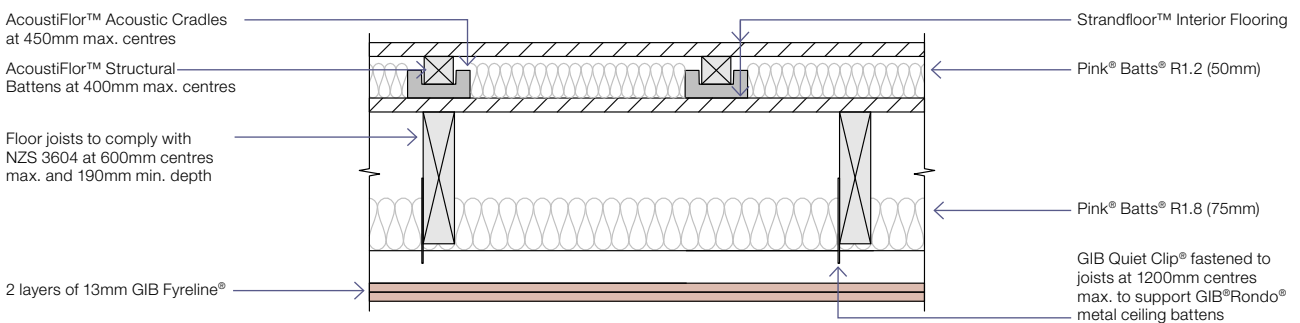

GNS021

Floor/ceiling — steel joists

Specification number	Performance	Specifications
GBSJA 45	STC 55	Lining 2 x 13mm GIB Fyreline®
	Rw 55	LB/NLB Load bearing
	FRR 45/45/45	IIC* 48–72

FLOOR FRAMING

Steel floor joists shall be a minimum 190mm deep C-section with 45mm flanges and a thickness of 1.55mm, spaced at no more than 600mm centres.

FLOORING

Flooring shall be nominal 20mm particle board or 20mm oriented strand board or minimum 17mm thick structural plywood fixed to the joists in accordance with the manufacturer's specifications. Flooring sheet joints must have a tongue and groove jointer, or be formed over framing.

If 17mm thick structural plywood is selected as the flooring material, one of the following floor coverings must be installed to achieve the listed STC and Rw performance:

- 4mm cushion-back vinyl; or,
- Wooden strip flooring; or,
- Ceramic tile; or,
- 40oz cut pile carpet loose laid on 8mm foam underlay.

GIB QUIET CLIP® AND BATTENS

The GIB Quiet Clip® is fastened to the joists at a maximum of 1200mm centres and minimum 900mm centres to support the GIB® Rondo® metal ceiling battens. Fasten each clip to the joist with 3 x 30mm x 10g Drill-Point Wafer Head Screws. The battens are spaced at a maximum of 600mm. A perimeter channel or GIBFix® Angle is required around the perimeter of the ceiling.

CEILING LINING

2 layers of 13mm GIB Fyreline® fixed at right angles to the battens.

Offset the joints of the outer layer by 600mm from those of the inner layer. All sheet end butt joints shall occur on battens and are offset between first and second layers. Sheet joints are touch fitted.

SOUND CONTROL INFILL

Pink® Batts® BIB R1.8 (75mm) glass wool insulation installed between the joists.

FASTENING THE LINING

Fasteners

Inner layer: 32mm x 6g GIB® Grabber® Self Tapping Drywall Screws.

Outer layer: 41mm x 6g GIB® Grabber® Self Tapping Drywall Screws.

Fastener centres (both layers)

200mm centres along each batten and 100mm centres at butt end joints. Place fasteners 12mm from sheet edges.

WALL/CEILING JUNCTIONS

The internal angle between the ceiling and walls must be protected by GIB-Cove® adhered with GIB-Cove® Bond, or boxed corners (square stopped) filled and taped in accordance with the publication entitled GIB® Site Guide.

ACOUSTIC SEALANT

A bead of GIB Soundseal® acoustic sealant is required on the inner lining around the ceiling perimeter. The outer lining is then bedded onto the bead.

JOINTING

All fastener heads stopped and all sheet joints tape reinforced and stopped in accordance with the publication entitled GIB® Site Guide.

*Impact Insulation Class (IIC)

A performance of IIC 48 is achieved by a bare floor.

A performance of IIC 51 is achieved with a floor covering of 4mm cushion-backed vinyl.

A performance of IIC 72 is achieved with a floor covering of 40oz cut pile carpet loose laid on 8mm foam underlay.

Note: See page 90 for perimeter details.

Floor/ceiling — steel joists

Specification number	Performance	Specifications
GBSJA 45	STC 55	Lining 2 x 13mm GIB Fyreline®
	Rw 55	LB/NLB Load bearing
	FRR 45/45/45	IIC* 48–72

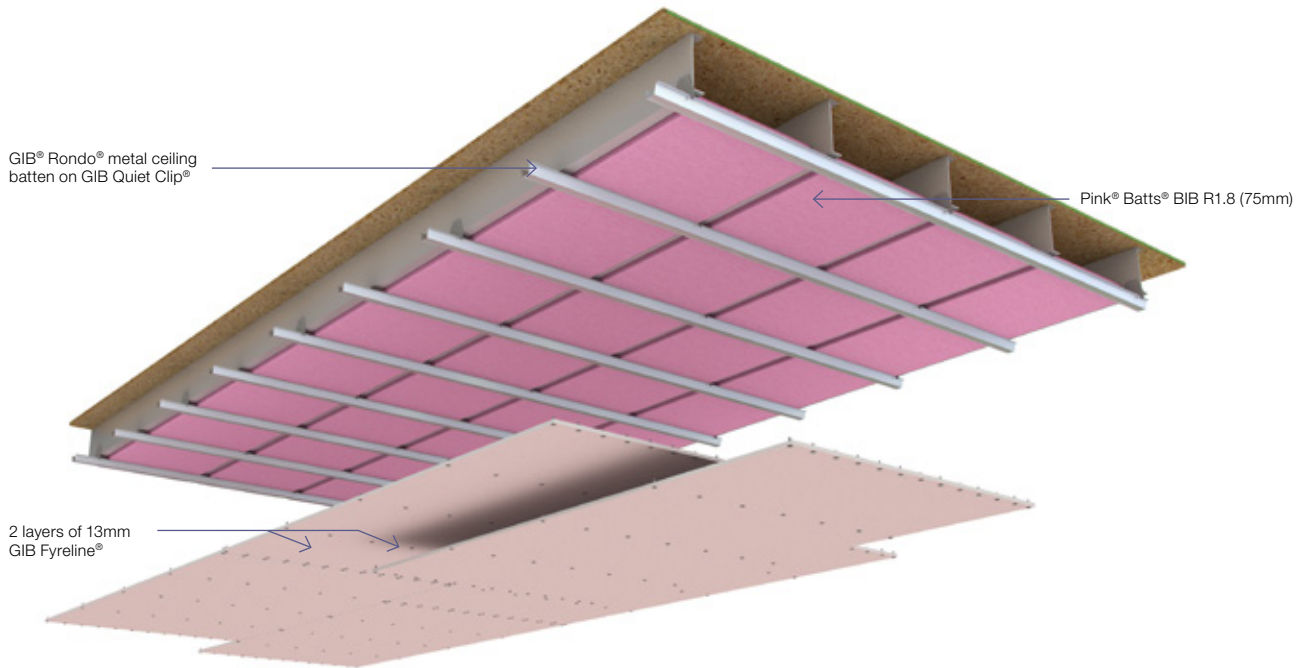

Floor/ceiling — steel joists

Specification number	Performance	Specifications
GBSJA 60	STC 56	Lining 1 x 16mm and 1 x 13mm GIB Fyreline®
	Rw 55	LB/NLB Load bearing
	FRR 60/60/60	IIC* 49–73

FLOOR FRAMING

Steel floor joists shall be a minimum 190mm deep C-section with 45mm flanges and a thickness of 1.55mm, spaced at no more than 600mm centres.

FLOORING

Flooring shall be nominal 20mm particle board or 20mm oriented strand board or minimum 17mm thick structural plywood fixed to the joists in accordance with the manufacturer's specifications. Flooring sheet joints must have a tongue and groove jointer, or be formed over framing.

If 17mm thick structural plywood is selected as the flooring material, one of the following floor coverings must be installed to achieve the listed STC and Rw performance:

- 4mm cushion-back vinyl; or,
- Wooden strip flooring; or,
- Ceramic tile; or,
- 40oz cut pile carpet loose laid on 8mm foam underlay.

GIB QUIET CLIP® AND BATTENS

The GIB Quiet Clip® is fastened to the joists at a maximum of 1200mm centres and minimum 900mm centres to support the GIB Rondo® metal ceiling battens. Fasten each clip to the joist with 3 x 30mm x 10g Drill-Point Wafer Head Screws. The battens are spaced at a maximum of 600mm. A perimeter channel or GIBFix® Angle is required around the perimeter of the ceiling.

CEILING LINING

1 layer 16mm (inner) and 1 layer 13mm GIB Fyreline® (outer) fixed at right angles to the battens.

Offset the joints of the outer layer by 600mm from those of the inner layer. All sheet end butt joints shall occur on battens and are offset between first and second layers. Sheet joints are touch fitted.

SOUND CONTROL INFILL

Pink® Batts® BIB R1.8 (75mm) glass wool insulation installed between the joists.

FASTENING THE LINING

Fasteners

Inner layer: 32mm x 6g GIB® Grabber® Self Tapping Drywall Screws.

Outer layer: 41mm x 6g GIB® Grabber® Self Tapping Drywall Screws.

Fastener centres (both layers)

200mm centres along each batten and 100mm centres at butt end joints. Place fasteners 12mm from sheet edges.

ACOUSTIC SEALANT

A bead of GIB Soundseal® acoustic sealant is required on the inner lining around the ceiling perimeter. The outer lining is then bedded onto the bead.

WALL/CEILING JUNCTIONS

The internal angle between the ceiling and walls must be protected by GIB-Cove® adhered with GIB-Cove® Bond, or boxed corners (square stopped) filled and taped in accordance with the publication entitled GIB® Site Guide.

JOINTING

Inner layer: Unstopped.

Outer layer: All fastener heads stopped and all sheet joints tape reinforced and stopped in accordance with the publication entitled GIB® Site Guide.

*Impact Insulation Class (IIC)

A performance of IIC 49 is achieved by a bare floor.

A performance of IIC 52 is achieved with a floor covering of 4mm cushion-backed vinyl.

A performance of IIC 73 is achieved with a floor covering of 40oz cut pile carpet loose laid on 8mm foam underlay.

Note: See page 90 for perimeter details.

Floor/ceiling — steel joists

Specification number	Performance	Specifications
GBSJA 60	STC 56	Lining 1 x 16mm and 1 x 13mm GIB Fyreline®
	Rw 55	LB/NLB Load bearing
	FRR 60/60/60	IIC* 49–73

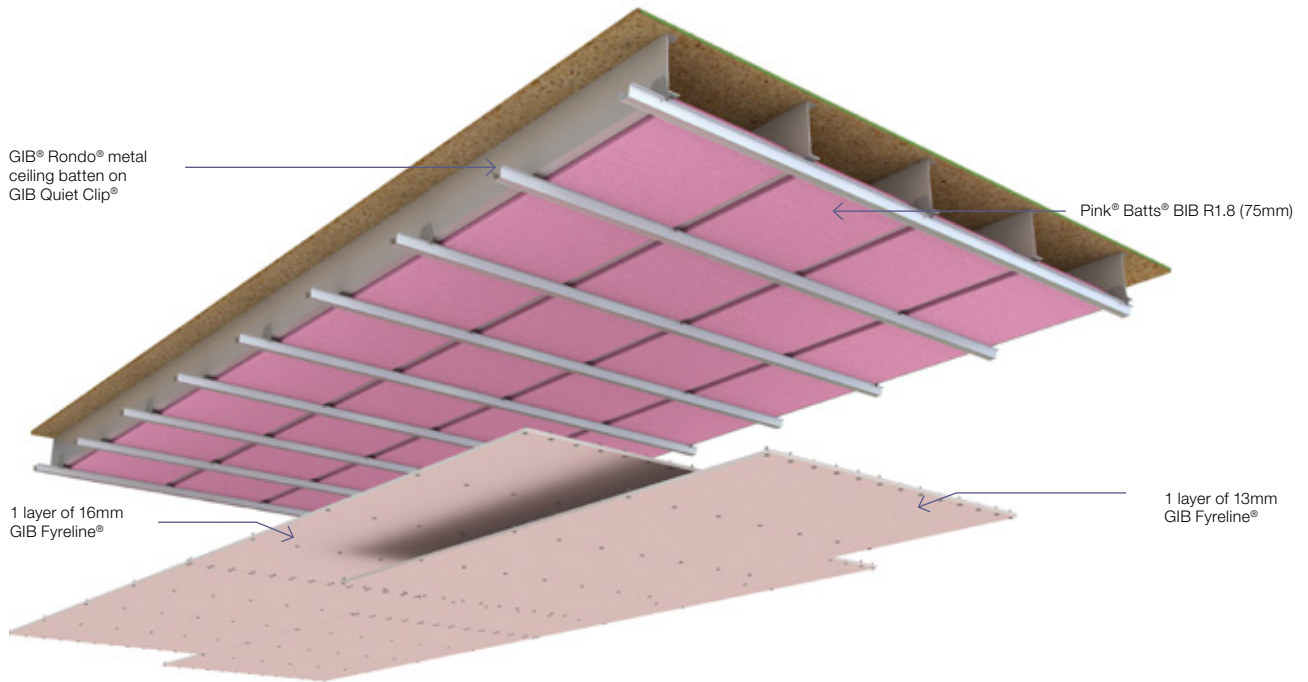

Floor/ceiling — suspended grid

Specification number	Performance	Specifications
GBSCA 45	STC 56 Rw 56 FRR 45/45/45	Lining 2 x 13mm GIB Fyreline® LB/NLB Load bearing IIC* 39–71

FLOOR FRAMING

Floor joists shall comply with NZS 3604. Joists shall be spaced at 600mm centres maximum and shall have a depth of 140mm minimum.

FLOORING

Minimum flooring shall be 20mm thick particle board or 20mm oriented strand board or 17mm thick structural plywood fixed to joists in accordance with the manufacturer's instructions. Nogs are required behind sheet joints. If tongue and groove flooring is used verification of performance must be obtained from the supplier of the flooring system.

SUSPENSION SYSTEM

USG Boral ScrewFix® steel frame suspension system comprising 2.5mm wire hangers at 1200mm centres supporting DJ38 strongback channels spaced at 1200mm centres and FC37 furring channels spaced at 600mm centres maximum. An alternative suspension system with at least equivalent layout, material properties, strength and stiffness may be used. The suspension system shall be installed in accordance with the manufacturer's instructions. The cavity depth shall be 275mm minimum (i.e. the distance between the underside of the flooring and the top of the ceiling linings).

SOUND CONTROL INFILL

Ceiling overlaid with Pink® Batts® BIB R1.8 (75mm) glass wool insulation.

CEILING LINING

2 layers of 13mm GIB Fyreline® fixed at right angles to the furring channels.

Offset the joints of the outer layer by 600mm from those of the inner layer. All sheet end butt joints must occur on the furring channel with those of the outer layer offset from those of the inner layer. Sheet joints are touch fitted.

FASTENING THE LINING

Fasteners

Inner layer: 32mm x 6g GIB® Grabber® Self Tapping Drywall Screws.

Outer layer: 41mm x 6g GIB® Grabber® Self Tapping Drywall Screws.

Fastener centres (both layers)

200mm centres around the ceiling perimeter and along each furring channel. 100mm centres where sheet end butt joints occur. Place fasteners no closer than 12mm to the sheet edges.

ACOUSTIC SEALANT

A bead of GIB Soundseal® acoustic sealant is required on the inner lining around the ceiling perimeter. The outer lining is then bedded onto the bead.

WALL/CEILING JUNCTIONS

The internal angle between the ceiling and walls are finished with GIB-Cove® adhered with GIB-Cove® Bond, or boxed corners (square stopped) filled and taped in accordance with the publication entitled GIB® Site Guide.

JOINTING

Inner layer: Unstopped.

Outer layer: All fastener heads stopped and all sheet joints tape reinforced and stopped in accordance with the publication entitled GIB® Site Guide.

*Impact Insulation Class (IIC)

A performance of IIC 39 is achieved with a bare floor.

A performance of IIC 43 is achieved with a floor covering of 4mm cushion-backed vinyl.

A performance of IIC 71 is achieved with a floor covering of 40oz cut pile carpet loose laid on 8mm foam underlay.

Note: See page 90 for perimeter details.

Floor/ceiling — suspended grid

Specification number	Performance	Specifications
GBSCA 45	STC 56	Lining 2 x 13mm GIB Fyreline®
	Rw 56	LB/NLB Load bearing
	FRR 45/45/45	IIC* 39–71

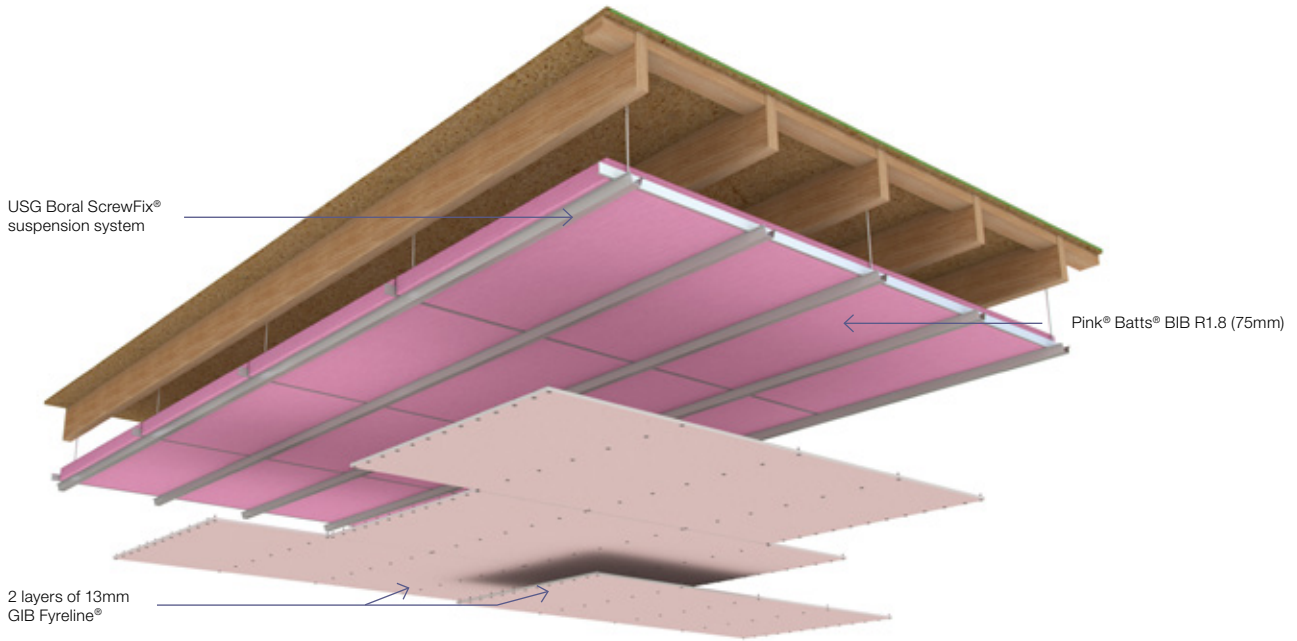

Floor/ceiling — suspended grid

Specification number	Performance	Specifications
GBSCA 60a	STC 56 Rw 56 FRR 60/60/60	Lining 1 x 13mm and 1 x 16mm GIB Fyreline® LB/NLB Load bearing IIC* 39–72

FLOOR FRAMING

Floor joists shall comply with NZS 3604. Joists shall be spaced at 600mm centres maximum and shall have a depth of 140mm minimum.

FLOORING

Minimum flooring shall be 20mm thick particle board or 20mm oriented strand board or 17mm thick structural plywood fixed to joists in accordance with the manufacturer's instructions. Nogs are required behind sheet joints. If tongue and groove flooring is used verification of performance must be obtained from the supplier of the flooring system.

SUSPENSION SYSTEM

USG Boral ScrewFix® steel frame suspension system comprising 2.5mm wire hangers at 1200mm centres supporting DJ38 strongback channels spaced at 1200mm centres and FC37 furring channels spaced at 600mm centres maximum. An alternative suspension system with at least equivalent layout, material properties, strength and stiffness may be used. The suspension system shall be installed in accordance with the manufacturer's instructions. The cavity depth shall be 275mm minimum (i.e. the distance between the underside of the flooring and the top of the ceiling linings).

SOUND CONTROL INFILL

Pink® Batts® BIB R1.8 (75mm) glass wool insulation installed between the joists.

CEILING LINING

1 layer of 13mm GIB Fyreline® (inner layer) plus 1 layer of 16mm GIB Fyreline® fixed at right angles to the furring channels.

Offset the joints of the outer layer by 600mm from those of the inner layer. All sheet end butt joints must occur on the furring channels with those of the outer layer offset from those of the inner layer. Sheet joints are touch fitted.

FASTENING THE LINING

Fasteners

Inner layer: 32mm x 6g GIB® Grabber® Self Tapping Drywall Screws.

Outer layer: 41mm x 6g GIB® Grabber® Self Tapping Drywall Screws.

Fastener centres (both layers)

200mm centres around the ceiling perimeter and along each furring channel. 100mm centres where sheet end butt joints occur. Place fasteners no closer than 12mm to the sheet edges.

ACOUSTIC SEALANT

A bead of GIB Soundseal® acoustic sealant is required on the inner lining around the ceiling perimeter. The outer lining is then bedded onto the bead.

WALL/CEILING JUNCTIONS

The internal angle between the ceiling and walls are finished with GIB-Cove® adhered with GIB-Cove® Bond, or boxed corners (square stopped) filled and taped in accordance with the publication entitled GIB® Site Guide.

JOINTING

Inner layer: Unstopped.

Outer layer: All fastener heads stopped and all sheet joints tape reinforced and stopped in accordance with the publication entitled GIB® Site Guide.

*Impact Insulation Class (IIC)

A performance of IIC 39 is achieved with a bare floor.

A performance of IIC 44 is achieved with a floor covering of 4mm cushion-backed vinyl.

A performance of IIC 72 is achieved with a floor covering of 40oz cut pile carpet loose laid on 8mm foam underlay.

Note: See page 90 for perimeter details.

Floor/ceiling — suspended grid

Specification number	Performance	Specifications
GBSCA 60a	STC 56	Lining 1 x 13mm and 1 x 16mm GIB Fyreline®
	Rw 56	LB/NLB Load bearing
	FRR 60/60/60	IIC* 39–72

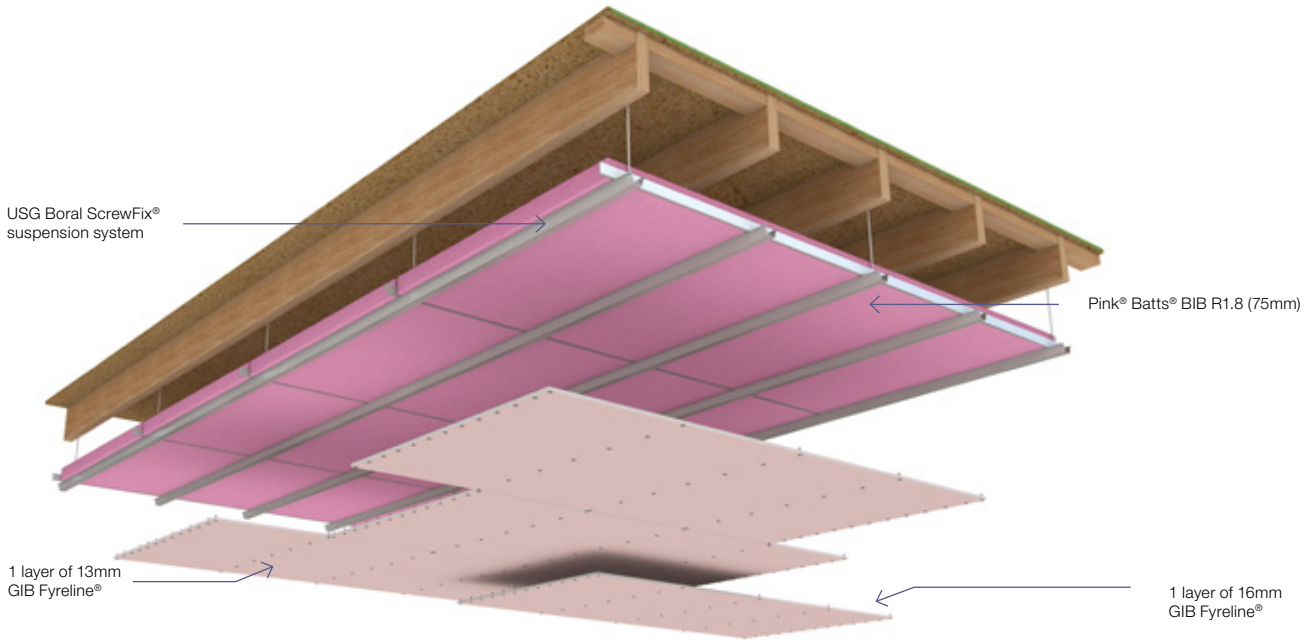

Two way FRR — steel frame wall — GIB® Rondo® Quiet Stud®

Specification number	Performance	Specifications
GBQSA 30	STC 52 Rw 51 FRR -/30/30	Lining 2 x 13mm GIB® Standard Plasterboard one side 1 x 13mm GIB® Standard Plasterboard other side LB/NLB Non load bearing Partition 131mm wide

FRAMING

Stud size	Space between frames
92 x 45 x 0.55mm	N/A

GIB® Rondo® Quiet Stud® resilient steel stud 92 x 45 x 0.55mm BMT and placed in 92 x 30 x 0.55mm BMT steel channel. Channel is fixed to floor and ceiling. Studs are friction fitted at 600mm centres with a 15mm expansion gap at the top of the frame. No fixings to the top channel.

WALL HEIGHTS

Recommended maximum wall height is 3800mm. For wall heights up to 4200mm place studs at 400mm centres. For greater heights please contact the GIB® Helpline.

SOUND CONTROL INFILL

Pink® Batts® R2.2 (90mm) glass wool insulation installed between the studs.

WALL LINING

2 layers of 13mm GIB® Standard Plasterboard one side and 1 layer of 13mm GIB® Standard Plasterboard the other side.

Linings are fixed vertically to the frame. Inner layer joints on opposite sides of the frame are offset. Vertical joints of the outer layer are offset 600mm from those of the inner layer. The inner layers must be fitted hard to floor. Use full height sheets where possible. Sheet joints are touch fitted and must occur over framing. Where sheet end joints are unavoidable they must be over nogs and outer layer joints offset from those on the inner layer.

ACOUSTIC SEALANT

A bead of GIB Soundseal® acoustic sealant is required around the perimeter of the inner lining. The outer lining is then bedded onto the bead.

FASTENING THE LINING

Fasteners

Inner and single layer: 25mm x 6g GIB® Grabber® Self Tapping Drywall Screws.

Outer layer: 41mm x 6g GIB® Grabber® Self Tapping Drywall Screws.

Fastener centres

Inner and outer layer: 300mm centres up each stud.

Place fasteners 12mm from sheet edges generally and 50mm from sheet ends.

JOINTING

Inner layer: Unstopped.

Outer layer: All fastener heads stopped and all sheet joints tape reinforced and stopped in accordance with the publication entitled GIB® Site Guide. Wall to ceiling junctions are to be reinforced with paper tape and square stopped or finished with GIB-Cove®.

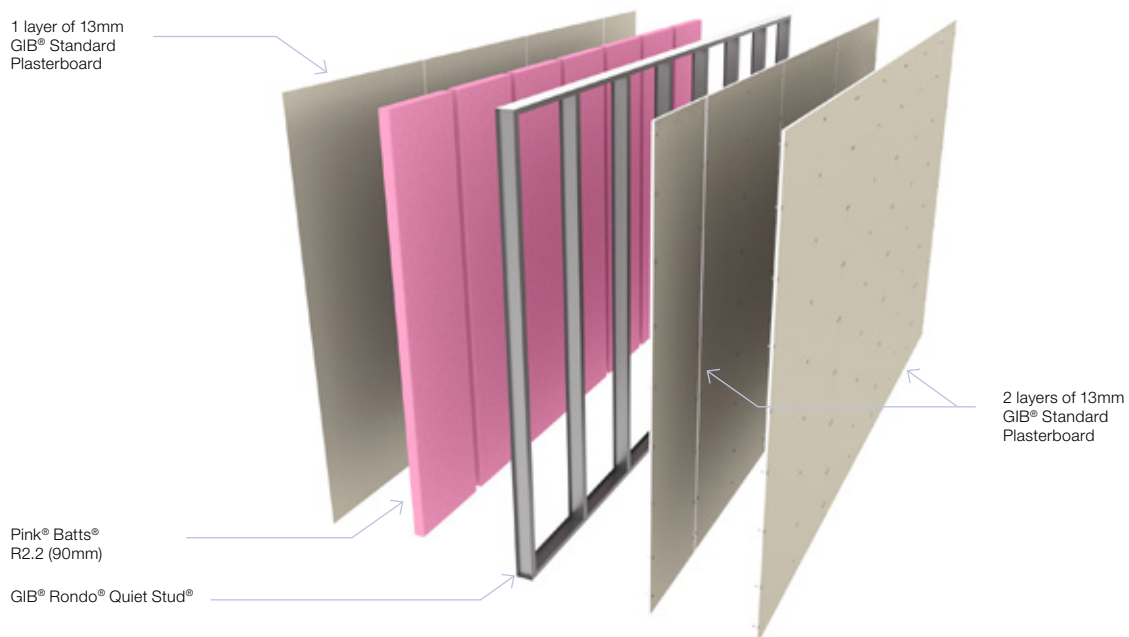

Two way FRR — steel frame wall — GIB® Rondo® Quiet Stud®

Specification number	Performance	Specifications
GBQSA 60	STC 49 Rw 50 FRR -/60/60	Lining 1 x 13mm GIB Braceline®/GIB Noiseline® each side LB/NLB Non load bearing Partition 118mm wide

FRAMING

Stud size	Space between frames
92 x 45 x 0.55mm	N/A

GIB® Rondo® Quiet Stud® resilient steel stud 92 x 45 x 0.55mm BMT and placed in 92 x 30 x 0.55mm BMT steel channel. Channel is fixed to floor and ceiling. Studs are friction fitted at 600mm centres maximum with a 15mm expansion gap at the top of the frame. No fixings to the top channel.

WALL HEIGHTS

Recommended maximum wall height is 3800mm. For wall heights up to 4200mm place studs at 400mm centres. For greater heights please contact the GIB® Helpline.

SOUND CONTROL INFILL

Pink® Batts® R2.2 (90mm) glass wool insulation installed between the studs.

WALL LINING

1 layer of 13mm GIB Braceline®/GIB Noiseline® fixed vertically each side of the frame.

Vertical joints are offset 600mm from those of the opposing side. Sheets must be fitted hard to floor. Use full height sheets where possible. Sheet joints are touch fitted and must occur over framing. Where sheet end joints are unavoidable they must be over nogs.

ACOUSTIC SEALANT

A bead of GIB Soundseal® acoustic sealant is required around the perimeter of the frame. The lining is then bedded onto the bead.

FASTENING THE LINING

Fasteners

25mm x 6g GIB® Grabber® Self Tapping Drywall Screws.

Fastener centres

300mm centres up each stud.

Place fasteners 12mm from sheet edges generally and 50mm from sheet ends.

JOINTING

All fastener heads stopped and all sheet joints tape reinforced and stopped in accordance with the publication entitled GIB® Site Guide. Wall to ceiling junctions are to be reinforced with paper tape and square stopped or finished with GIB-Cove®.

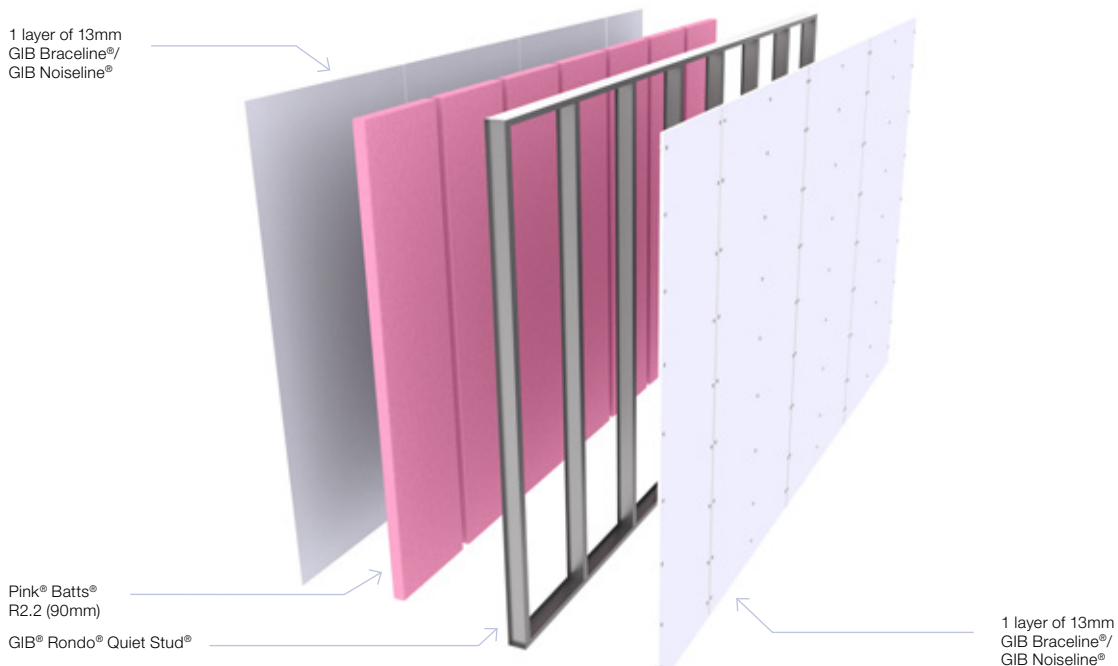

Single steel frame wall

Specification number	Linings	Thickness	Layers Side 1	Layers Side 2	STC
GSS132	GIB® Standard Plasterboard	13mm	1	1	41
GSS133			1	2	44
GSS134			2	2	48
GNS104	GIB Braceline®/GIB Noiseline®	10mm	2	2	48
GNS132		13mm	1	1	43
GNS133			1	2	45
GNS134			2	2	52

FRAMING

Framing to comply with all relevant sections and clauses of the New Zealand Building Code. Minimum stud size 64 x 34 x 0.50mm BMT.

Warning: The STC performance figures listed in the table above are based on studs spaced at 600mm centres. Reducing stud centres to less than 600mm will significantly lower the STC performance of these systems.

SOUND CONTROL INFILL

Pink® Batts® BIB R1.8 (75mm) glass wool insulation installed between the studs and nogs.

WALL LINING

GIB® plasterboard as prescribed in the tables above.

Joints of the outer layer are generally offset 600mm from those of the inner layer. The outer layer may be fixed horizontally over vertical inner layer.

Full height sheets are used where possible. Where sheet end butt joints are unavoidable they must be formed over nogs with those of the outer layer offset from those of the inner layer. Sheet joints are touch fitted.

Where a Fire Resistance Rating (FRR) is required, refer to the GIB® Fire Rated Systems Manual for special fastener lengths and centres requirements.

ACOUSTIC SEALANT

A bead of GIB Soundseal® acoustic sealant is required around the perimeter of the framing (on single layers) and around the perimeter of the inner lining on double layers. The linings are then bedded onto the bead.

FASTENING THE LINING

Fasten the linings in accordance with the GIB® Site Guide. If an FRR is required refer to the relevant specification sheet in the GIB® Fire Rated Systems Manual for the correct fastener type and layout.

JOINTING

Inner layer: Unstopped.

Outer layer: All fastener heads stopped and all sheet joints tape reinforced and stopped in accordance with the publication entitled GIB® Site Guide. Wall to ceiling junctions are to be reinforced with paper tape and square stopped or finished with GIB-Cove®.

Layers of GIB® Standard Plasterboard as prescribed in table above

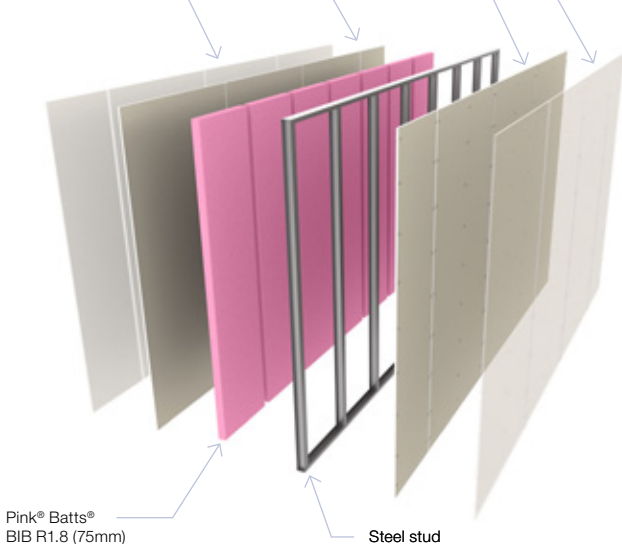

Layers of 10mm or 13mm GIB Braceline®/GIB Noiseline® as prescribed in table above

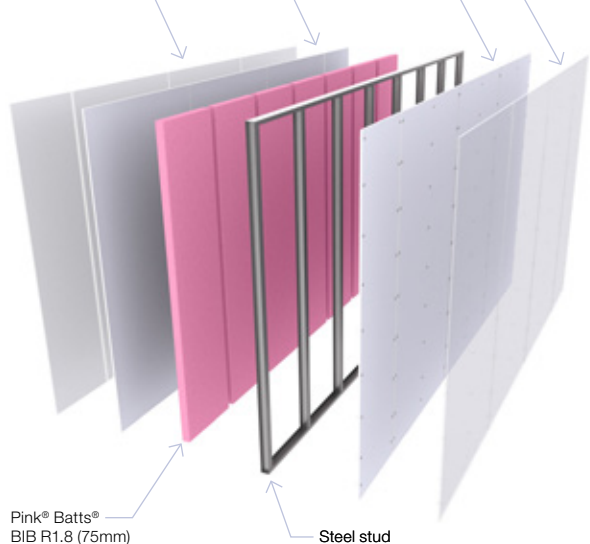

Single timber frame wall

Specification number	Linings	Thickness	Layers Side 1	Layers Side 2	STC
GST102	GIB® Standard Plasterboard	10mm	1	1	39
GST103			1	2	42
GST104			2	2	44
GST132		13mm	1	1	40
GST133			1	2	43
GST134			2	2	46
GNT102	GIB Braceline®/GIB Noiseline®		10mm	1	1
GNT103		1		2	44
GNT104		2		2	46
GNT132		13mm	1	1	41
GNT133			1	2	46
GNT134			2	2	48

FRAMING

Framing to comply with all relevant sections and clauses of the New Zealand Building Code. Minimum stud size 70 x 45mm.

Warning: The STC performance figures listed in the table above are based on studs spaced at 600mm centres. Reducing stud centres to less than 600mm will significantly lower the STC performance of these systems.

SOUND CONTROL INFILL

Pink® Batts® R2.2 (90mm) glass wool insulation installed between the studs and nogs.

WALL LINING

GIB® plasterboard as prescribed in the tables above. Joints of the outer layer are generally offset 600mm from those of the inner layer. The outer layer may be fixed horizontally over vertical inner layer.

Full height sheets are used where possible. Where sheet end butt joints are unavoidable they must be formed over nogs with those of the outer layer offset from those of the inner layer. Sheet joints are touch fitted.

Where a Fire Resistance Rating (FRR) is required, refer to the GIB® Fire Rated Systems Manual for special fastener lengths and centres requirements.

ACOUSTIC SEALANT

A bead of GIB Soundseal® acoustic sealant is required around the perimeter of the framing (on the single layer side) and around the perimeter of the inner lining on the other side. The linings are then bedded onto the bead.

FASTENING THE LINING

Fasten the linings in accordance with the GIB® Site Guide. If an FRR is required refer to the relevant specification sheet in the GIB® Fire Rated Systems Manual for the correct fastener type and layout.

JOINTING

Inner layer: Unstopped.

Outer layer: All fastener heads stopped and all sheet joints tape reinforced and stopped in accordance with the publication entitled GIB® Site Guide. Wall to ceiling junctions are to be reinforced with paper tape and square stopped or finished with GIB-Cove®.

Layers of GIB® Standard Plasterboard as prescribed in table above

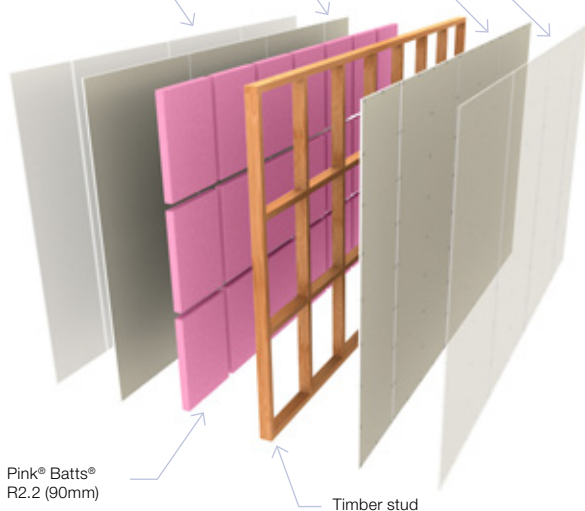

Layers of 10mm or 13mm GIB Braceline®/GIB Noiseline® as prescribed in table above

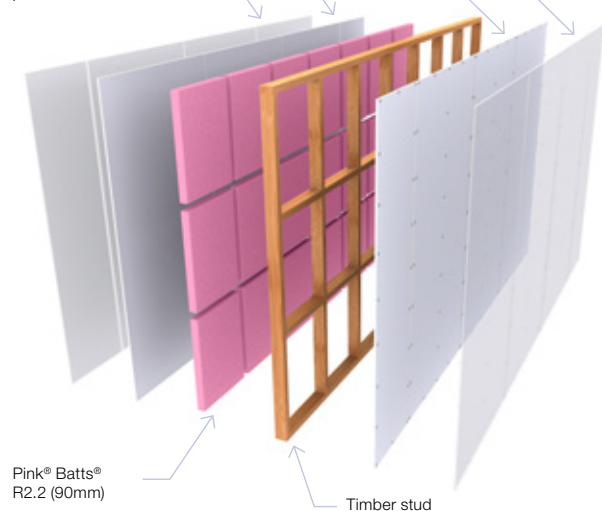

Floor/ceiling — timber joists

Specification number	Performance	Specifications
GBDFA 30a	STC 53	Lining 2 x 13mm GIB® Standard Plasterboard
	Rw 52	LB/NLB Load bearing
	FRR 30/30/30	IIC* 42–65

FLOOR FRAMING

Floor joists shall comply with NZS 3604. Joists shall be spaced at 600mm centres maximum and shall have a depth of 140mm minimum.

Alternative Floor framing

Use either Hyspan® or Hybeam® HJ series joists designed for strength and serviceability, no less than 150mm deep and spaced at no more than 600mm. Consult the joist manufacturer regarding construction of the solid blocking contained in the floor/ceiling to wall junctions.

FLOORING

Flooring shall be nominal 20mm particle board or 20mm oriented strand board or minimum 17mm thick structural plywood fixed to the joists in accordance with the manufacturer's specifications. Flooring sheet joints must have a tongue and groove jointer, or be formed over framing.

GIB QUIET CLIP® AND BATTENS

The GIB Quiet Clip® shall be fastened to the joists at maximum 1200mm centres (and no less than 900mm centres) to support the GIB® Rondo® metal ceiling battens. The battens shall be spaced at 600mm centres maximum.

INSTALLING THE GIB QUIETCLIP®

Use 3 x 32mm x 8g GIB® Grabber® Self Tapping Wafer Head Screws. Insert the first screw into the middle rubber grommet, tighten enough to hold the GIB Quiet Clip® in place, adjust the clip to the correct height, insert the remaining two screws and tighten. Do not over tighten the screws to a point where the grommet is crushed. The screws should be tightened enough to allow the flexibility to remain in the connection between the grommet and the joists.

SOUND CONTROL INFILL

Ceiling overlaid with Pink® Batts® Silencer® (100mm) glass wool insulation.

CEILING LINING

2 layers of 13mm GIB® Standard Plasterboard fixed at right angles to the steel battens.

Offset the joints of the outer layer by 600mm from those of the inner layer.

All sheet end butt joints shall occur on the battens and are offset between the first and second layers.

Sheet joints are touch fitted.

FASTENING THE LINING

Fasteners

Inner layer: 25mm x 6g GIB® Grabber® Self Tapping Drywall Screws.

Outer layer: 41mm x 6g GIB® Grabber® Self Tapping Drywall Screws.

Fastener centres (both layers)

200mm centres along each batten and at 100mm centres along sheet end butt joints. Place fasteners no closer than 12mm to the sheet edges.

ACOUSTIC SEALANT

A bead of GIB Soundseal® acoustic sealant is required on the inner lining around the ceiling perimeter.

WALL/CEILING JUNCTIONS

The internal angle between the ceiling and walls are finished with GIB-Cove® adhered with GIB-Cove® Bond, or boxed corners (square stopped) filled and taped in accordance with the publication entitled GIB® Site Guide.

JOINTING

Inner layer: Unstopped.

Outer layer: All fastener heads stopped and all sheet joints tape reinforced and stopped in accordance with the publication entitled GIB® Site Guide.

*Impact Insulation Class (IIC)

A performance of IIC 42 is achieved with a bare floor.

A performance of IIC 44 is achieved with a floor covering of 4mm cushion-backed vinyl.

A performance of IIC 65 is achieved with a floor covering of 40oz cut pile carpet loose laid on 8mm foam underlay.

Note: See page 90 for perimeter details.

Floor/ceiling — timber joists

Specification number	Performance	Specifications
GBDFA 30a	STC 53	Lining 2 x 13mm GIB® Standard Plasterboard
	Rw 52	LB/NLB Load bearing
	FRR 30/30/30	IIC* 42–65

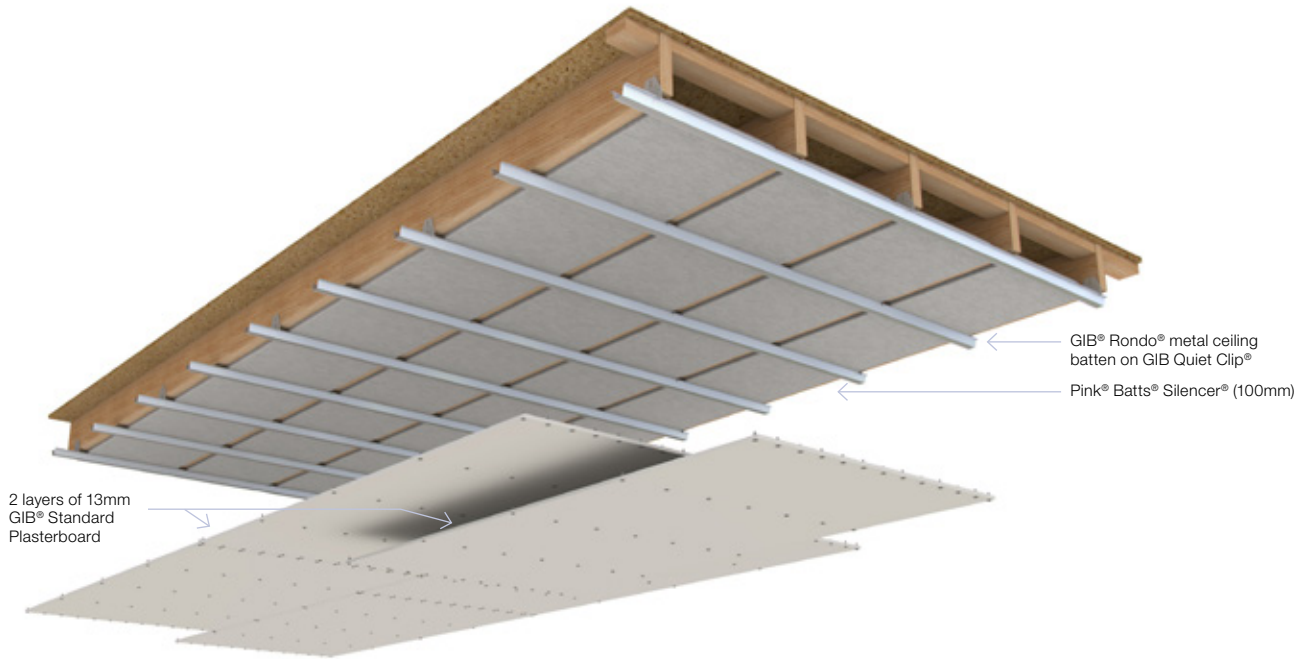

Floor/ceiling — timber joists

Specification number	Performance	Specifications
GBDFA 30d	STC 51	Lining 1 x 13mm GIB Braceline®/GIB Noiseline®
	Rw 51	LB/NLB Load bearing
	FRR 30/30/30	IIC* 41–65

FLOOR FRAMING

Floor joists shall comply with NZS 3604, be spaced at 600mm centres maximum and have a depth of 190mm minimum.

Alternative Floor framing

Use either Hyspan® or Hybeam® HJ series joists designed for strength and serviceability, no less than 150mm deep and spaced at no more than 600mm. Consult the joist manufacturer regarding construction of the solid blocking contained in the Floor/ceiling to wall junctions.

FLOORING

Flooring shall be nominal 20mm particle board or 20mm oriented strand board or minimum 17mm thick structural plywood fixed to the joists in accordance with the manufacturer's specifications. Flooring sheet joints must have a tongue and groove jointer, or be formed over framing.

GIB QUIET CLIP® AND BATTENS

The GIB Quiet Clip® shall be fastened to the joists at maximum 1200mm centres (and no less than 900mm centres) to support the GIB® Rondo® metal ceiling battens. The battens shall be spaced at 600mm centres maximum.

INSTALLING THE GIB QUIETCLIP®

Use 3 x 32mm x 8g GIB® Grabber® Self Tapping Wafer Head Screws. Insert the first screw into the middle rubber grommet, tighten enough to hold the GIB Quiet Clip® in place, adjust the clip to the correct height, insert the remaining two screws and tighten. Do not over tighten the screws to a point where the grommet is crushed. The screws should be tightened enough to allow the flexibility to remain in the connection between the grommet and the joists.

SOUND CONTROL INFILL

Ceiling overlaid with Pink® Batts® Silencer® (100mm) glass wool insulation.

CEILING LINING

1 layer of 13mm GIB Braceline®/GIB Noiseline® fixed at right angles to the battens.

All sheet end butt joints shall occur on the battens. Sheet joints are touch fitted. Where a Fire resistance rating is required all joints must be back-blocked in accordance with the publication entitled GIB® Site Guide.

Note: If a Fire resistance rating is required, refer GBSC 30 in the publication GIB® Fire Rated Systems.

FASTENING THE LINING

Fasteners

25mm x 6g GIB® Grabber® Self Tapping Drywall Screws.

Fastener centres

200mm centres along each batten and 100mm centres along sheet end butt joints. Place fasteners no closer than 12mm to the sheet edges.

ACOUSTIC SEALANT

A bead of GIB Soundseal® acoustic sealant is required on the inner lining around the ceiling perimeter.

WALL/CEILING JUNCTIONS

The internal angle between the ceiling and walls are finished with GIB-Cove® adhered with GIB-Cove® Bond, or boxed corners (square stopped) filled and taped in accordance with the publication entitled GIB® Site Guide.

JOINTING

All fastener heads stopped and all sheet joints tape reinforced and stopped in accordance with the publication entitled GIB® Site Guide.

*Impact Insulation Class (IIC)

A performance of IIC 41 is achieved with a bare floor.

A performance of IIC 43 is achieved with a floor covering of 4mm cushion-backed vinyl.

A performance of IIC 65 is achieved with a floor covering of 40oz cut pile carpet loose laid on 8mm foam underlay.

Note: See page 90 for perimeter details.

Floor/ceiling — timber joists

Specification number	Performance	Specifications
GBDFA 30d	STC 51 Rw 51 FRR 30/30/30	Lining 1 x 13mm GIB Braceline®/GIB Noiseline® LB/NLB Load bearing IIC* 41–65

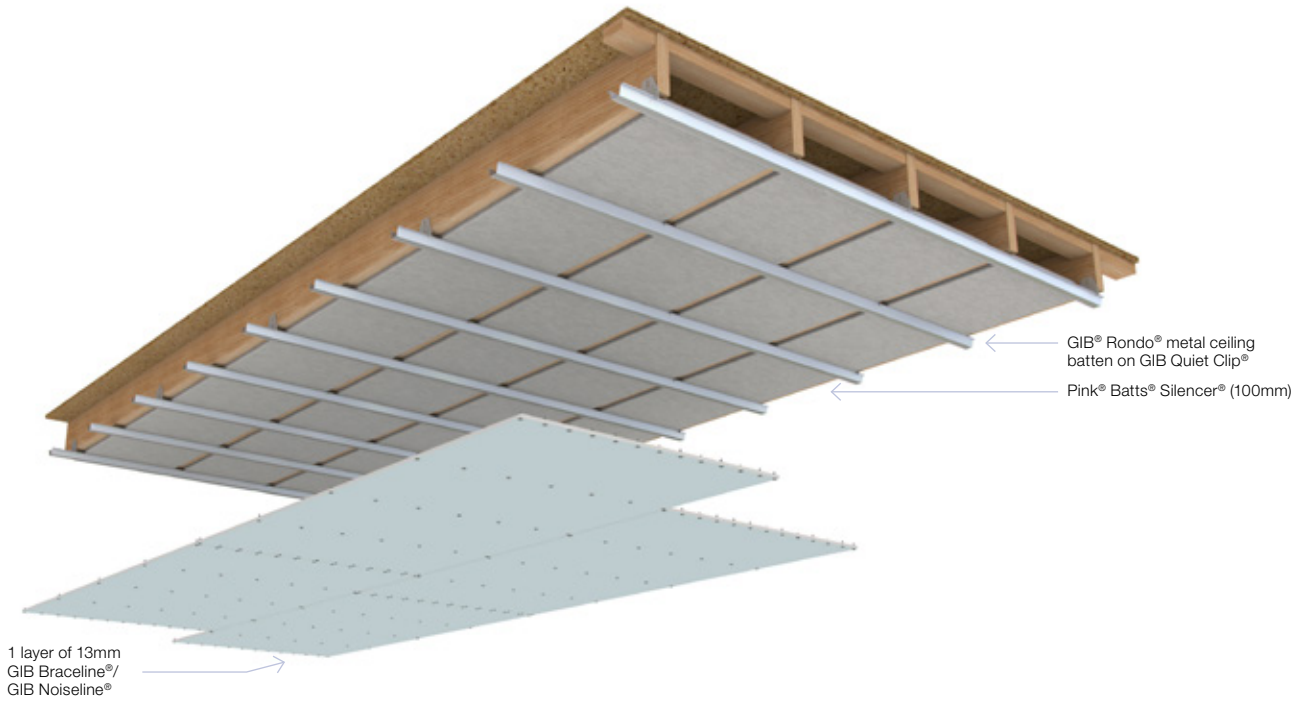

Introduction

Any penetration in a wall, floor, or ceiling (e.g. light fitting, power outlet, pipe, HVAC, door) has the potential to degrade noise control.

Fire Resistance Ratings

It is important to note that penetrations can also degrade fire resistance ratings. The degree of degradation depends on the specific system and components involved. If a fire resistance rating is required, the fire resistance rating of the penetration detail must be assessed. Refer to the relevant sections in this publication, GIB® Fire Rated Systems and GIB® Intertenancy Barrier Systems for Terrace Homes for appropriate penetration details.

How penetrations and fixings degrade noise control

Common ways penetrations degrade noise control are:

- Introduction of leaks e.g. minute air gaps through door jambs or light switches, or small gaps around pipes or through down lights.
- Replacing a portion of a GIB Noise Control® System with a material that has less noise control e.g. a door, flush box or down light into a wall or ceiling.
- Introduction of a structural connection between linings e.g. a service pipe connected to both sides of a wall.
- Placement of a sound source within a building system e.g. a water pipe in a wall or ceiling introduces a noise source into the cavity. Moreover, mounting the pipe on a frame or lining causes the lining to radiate sound directly which can amplify the sound.
- Mounting fixtures and appliances that are likely to be a source of noise to intertenancy walls e.g. telephones, TV sets, dryers, stereos and cupboard doors with doors.

To avoid the degradation of the noise control performance, locate appliances on external or other non-critical walls. When positioned on the floor, place them on resilient mountings.

To limit transmission of impact noise on walls, soft close drawers and cupboard doors are a simple and effective solutions for cabinetry.

Building service penetrations in central barrier walls

Walls with GIB Barrierline® and 13mm GIB Fyreline® central barriers allow installation of plumbing and electrical services in the cavities either side of the central barrier. Back-to-back services and penetrations are permitted within the limitations given below. A minimum of 10mm clearance must be provided between plumbing or electrical services and the central barrier.

Metal and PVC plumbing services up to 65mm in diameter do not need specialist fire-stopping where they penetrate the wall linings. Penetrations through wall linings must have neatly cut holes with 6mm maximum clearance around the plumbing service. Fill the gap with a general purpose flexible sealant.

Electrical services up to 90 x 50mm that penetrate wall linings do not need to be fire-stopped. Limit flush boxes to two per nominally 600mm wide framing cavity.

Suitable proprietary fire-stopping is required for wall lining penetrations larger than 90 x 50mm or 65mm diameter, and for penetrations through the GIB Barrierline® or 13mm GIB Fyreline® central barriers.

The importance of sound sealant

Even minute gaps degrade noise control. Think of filling a room with water; where the water can leak, so can sound.

To illustrate this, compare a wall measured in an acoustic laboratory before and after applying sealant to the perimeter. Even though the gaps were tiny (under bottom plates and around plasterboard fixed firmly against plates), without sound sealant the STC rating dropped 20 dB.

Mouldings (e.g. architraves), paint and wallpaper are generally not sufficient to stop sound leaks. GIB Soundseal® offers high mass and elasticity to accommodate building movement; do not use a general purpose gap filler.

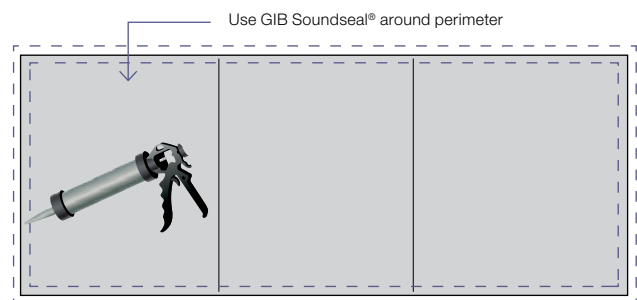

Flush boxes

All timber and steel frame GIB® Central Barrier Walls allow for installation of electrical flush boxes either side of the central barrier, without any acoustic or fire sealing required. Back-to-back services and penetrations are permitted within limitations.

For all other wall types offset flush boxes in adjacent stud bays. Use GIB Soundseal® around the flush box perimeter, and continue insulation behind the box. Where this is not possible use surface mounted boxes. Use a fire rated sealant around the perimeter of a fire rated flush box.

The diagrams on the following page provide options for flush box placement, cavity insulation, and framing scenarios. Results are for single size flush boxes, no more than four each side of a wall. Note that some options degrade noise control. For single and staggered framed walls rated higher than STC 55 and double framed walls higher than STC 60 the expected degradation may be greater.

Back-to-back flush box remedy

Double frame walls:

A baffle may be used (see details on next page), when:

- The baffle does not bridge the two frames.
- Cavity insulation is placed:
 1. In the box created by the baffle, and
 2. Between the baffle and the lining on the other wall frame.

Down lights

It is best practice to avoid recessed lights in intertenancy ceilings. However, where necessary, recessed lights may be used with minimal impact provided:

- They are positioned less than one every 4m²,
- Insulation is used in the ceiling cavity,
- They are limited to 100mm x 100mm per downlight, and
- They are installed in accordance with the manufacturer's specification and relevant standards with respect to ventilation requirements.

OFFSET FLUSH BOX DETAIL

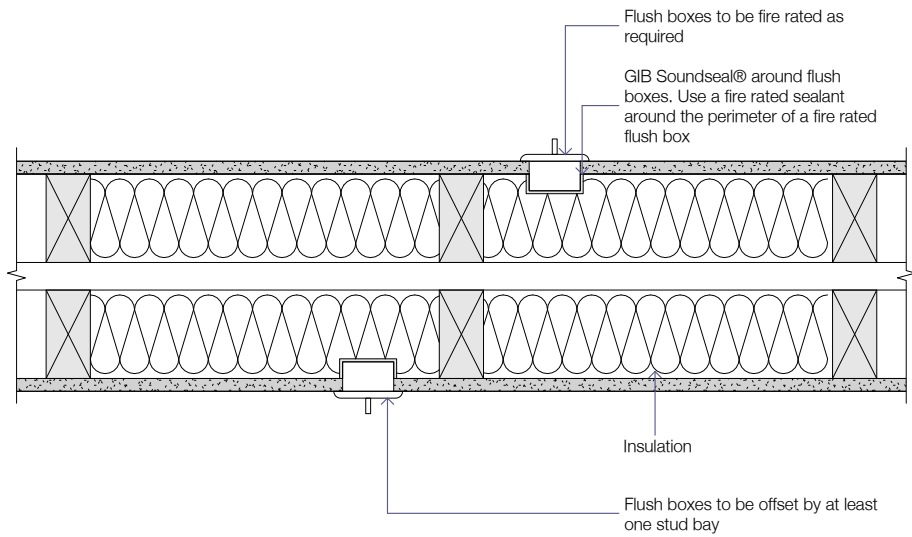

GNS040

BACK TO BACK FLUSH BOX DETAIL

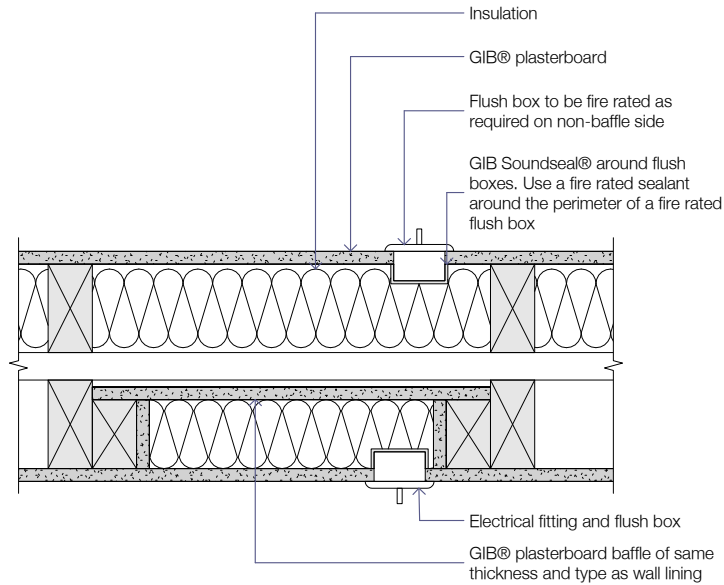

GNS041

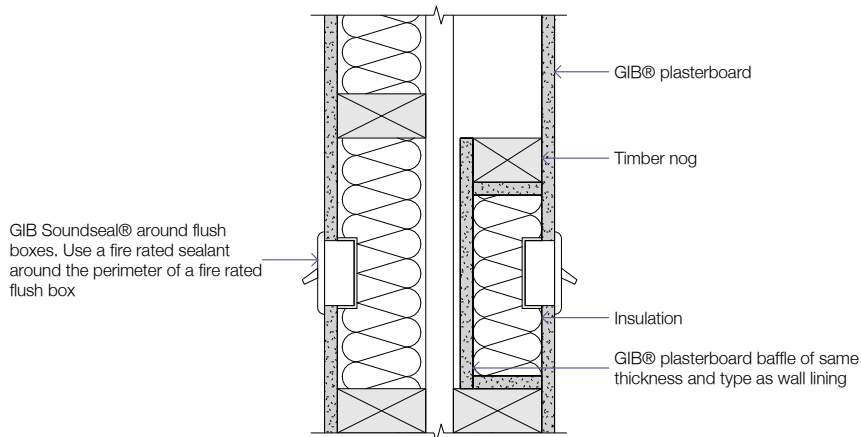

GNS042

Doors

The NZBC has no noise control requirements for doors, including doors from dwellings to corridors. However, doors usually limit the noise control performance of a system and a minimum performance is required to meet design acoustic comfort and satisfy occupants.

The noise control rating of a wall with a door will usually be limited by the performance of the door, as shown below. Here a 10m² wall is rated STC 55 (without a door) and a 1.8m² door assembly rated STC 30 (e.g. a solid core door with perimeter seals) is installed. The total STC for the wall with the door is only STC 36. The door has reduced the wall performance significantly. If the rating of the wall was increased to STC 65, the total rating would still be STC 36.

ACOUSTIC RATED WALL SYSTEM LIMITED BY DOOR PERFORMANCE

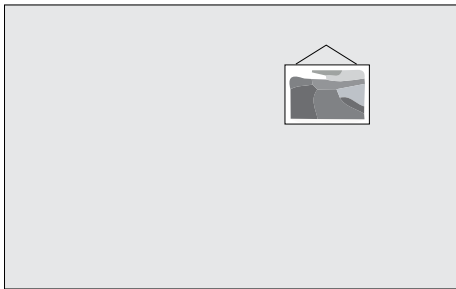

Wall = STC 55

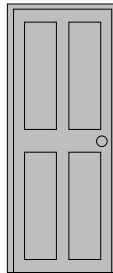

Door = STC 30

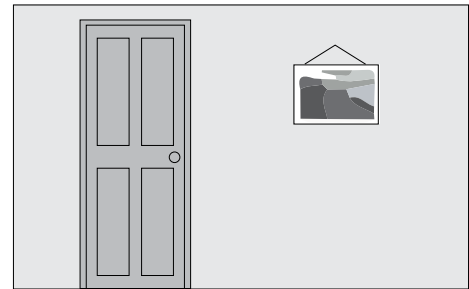

Wall and door = STC 36

EFFECT OF DOOR TYPE AND DOOR AND WALL AREA ON STC

Door and wall area (m ²)	36mm hollow core door – no gaps = STC 18	36mm solid core door with seals = STC 30
	Door and STC 55 wall	Door and STC 55 wall
6	24	34
10	25	36
15	27	38
20	28	39

The table above provides examples of how combining different doors and walls affects STC. Wall size relative to door size can make a modest difference.

Therefore, it is essential to select a door assembly consistent with the design comfort level.

A range of door options are:

- Solid core – seals, STC ~ 28 to 32 suitable with entry level noise control walls.

- Double door set, STC ~ 45 to 50 pairs of back-to-back doors (solid core with seals) separated by 30mm or more, with sound absorbing material on one face.
- Proprietary noise control doors, STC ~ 36 to 50.
- Sound lobby, STC ~ 50+. Usually comprises two solid doors with seals separated by a small room. Note: Where sound passes through a door, along a corridor, and through another door there is essentially a sound lobby.

SOLID CORE DOOR SYSTEM EXAMPLE

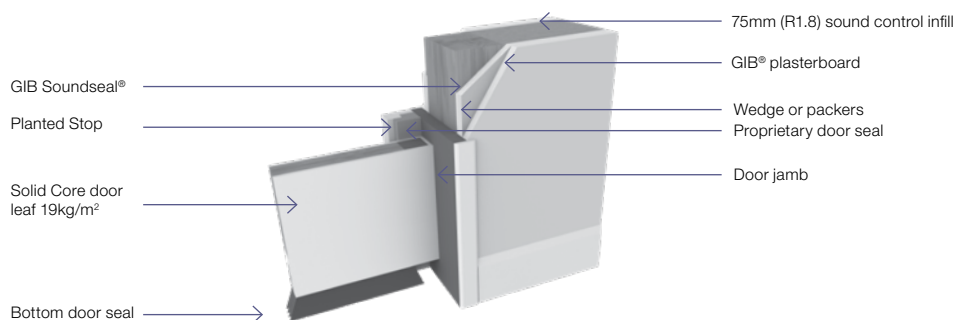

STUD AND GIB RAIL®

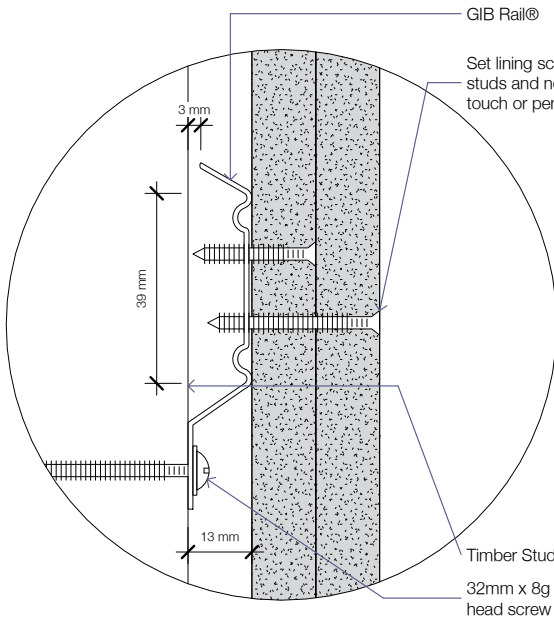

GNS060

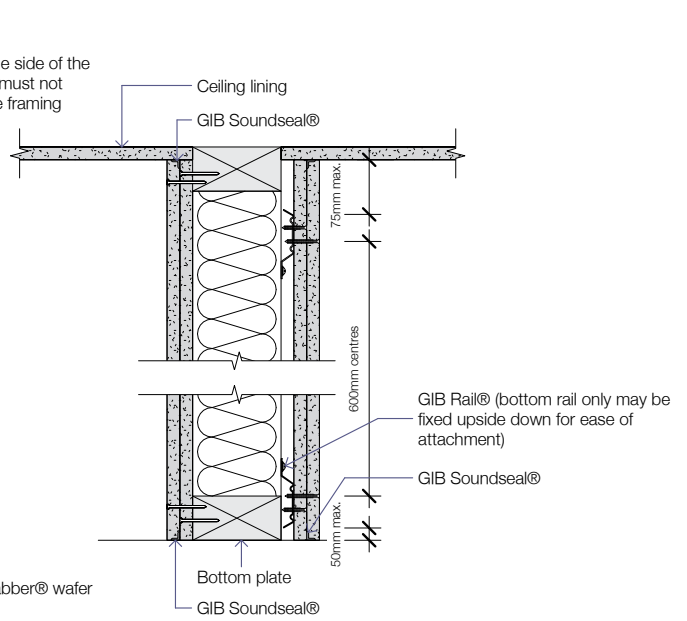

GNS061

STUD AND ST-001 CLIP

Rondo® 308 or USG FC37 furring channel

Set lining screws to the side of the studs and nogs, they must not touch or penetrate the framing

ST-001 Clip fixed with a 63mm x 8g self tapping screw

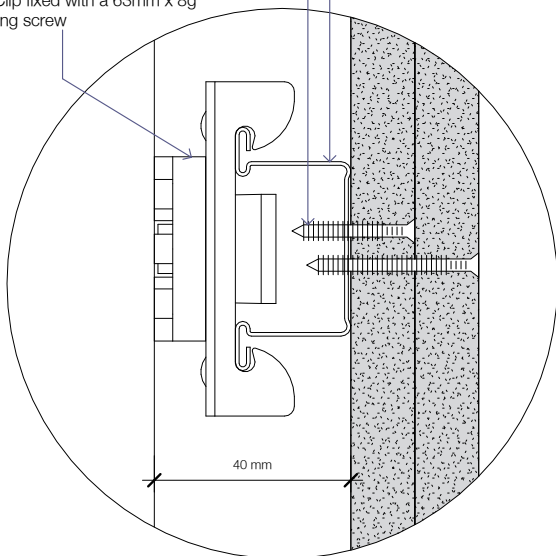

GNS062

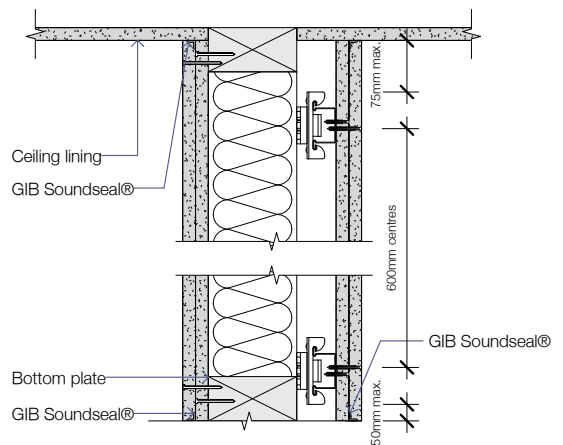

GNS063

SUSPENDED

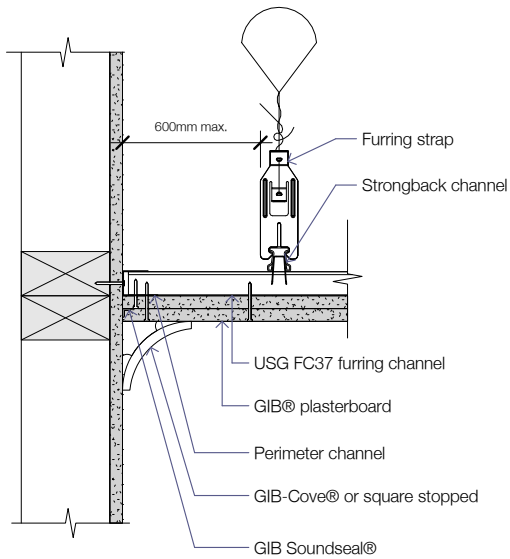

GNS080

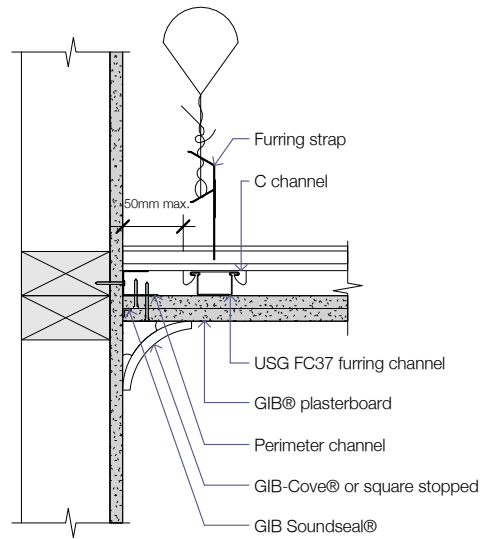

GNS081

DIRECT FIX CLIP AND BATTEN

For superior low frequency performance, substitute the GIB® Direct Fix Clip with the GIB Quiet Clip®. The GIB Quiet Clip® offers up to 8 dB improved attenuation in the frequency range 50Hz to 125Hz. As foot fall and other common domestic sounds are often in this range, the GIB Quiet Clip® offers significant advantage over direct fix systems.

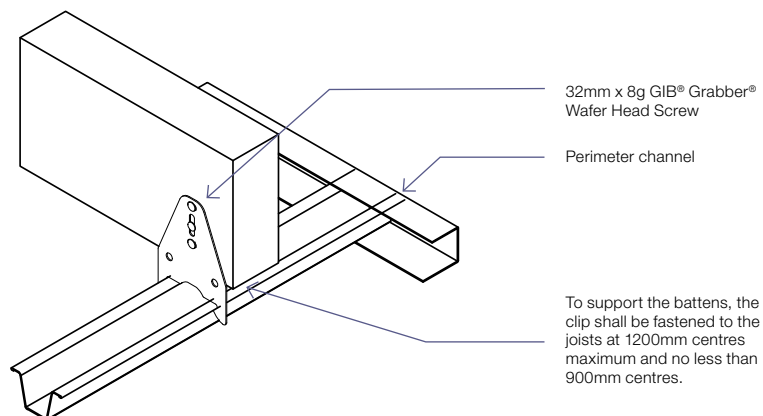

GNS082

DETAIL AT UPPER STOREY FRAMED FLOOR (END ELEVATION)

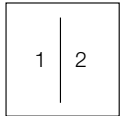
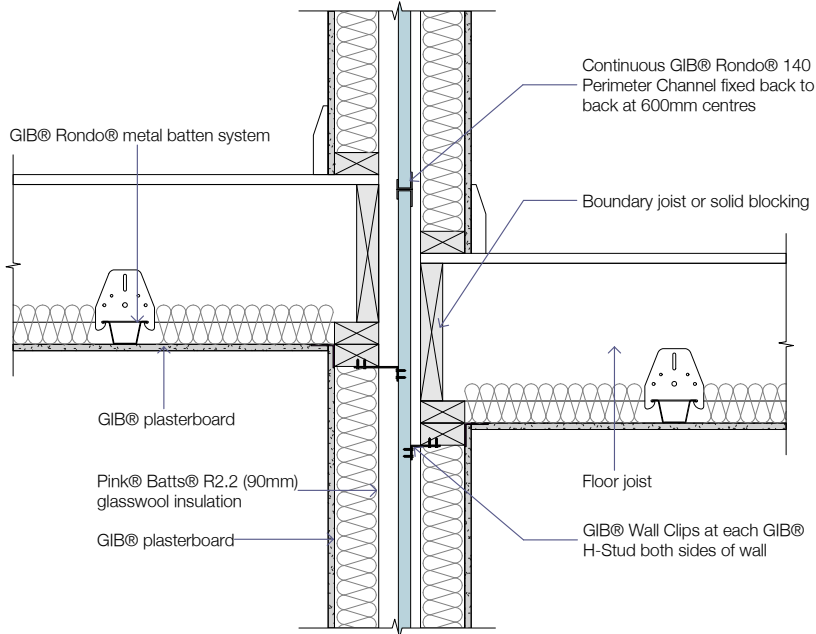

Unit layout

GNS100

BASE DETAIL AT SLAB (END ELEVATION)

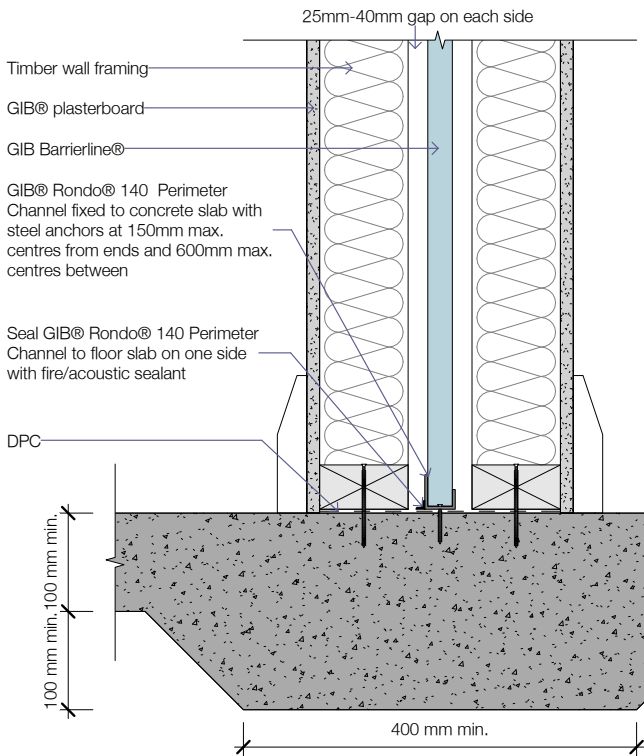

GNS101

DETAIL AT CORNER (PLAN VIEW)

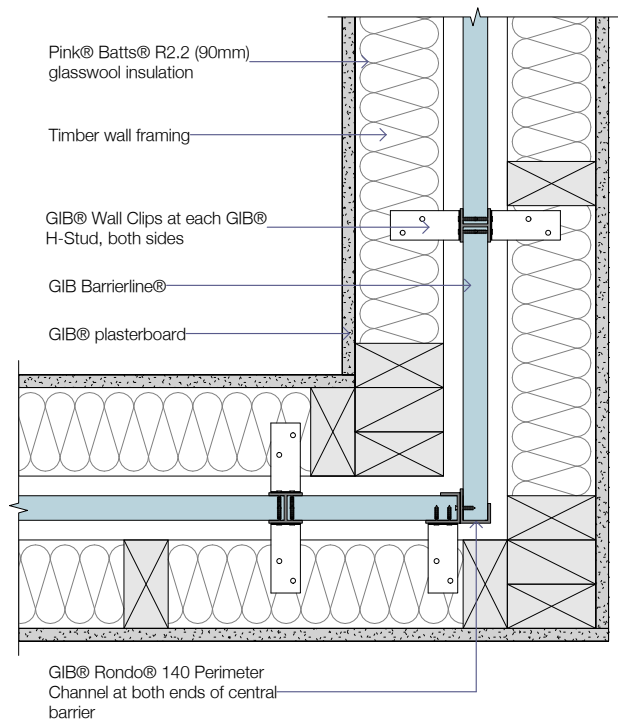

GNS102

DETAIL AT EXTERNAL TIMBER FRAME WALL (PLAN VIEW)

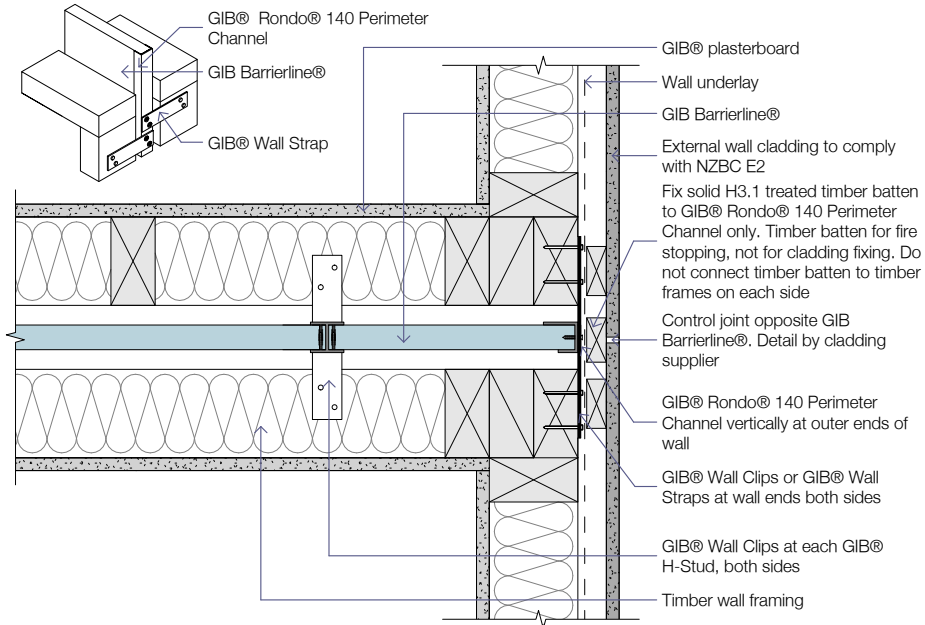

GNS103

INTERTENANCY WALL PROJECTION AT EXTERNAL TIMBER FRAME WALL (PLAN VIEW)

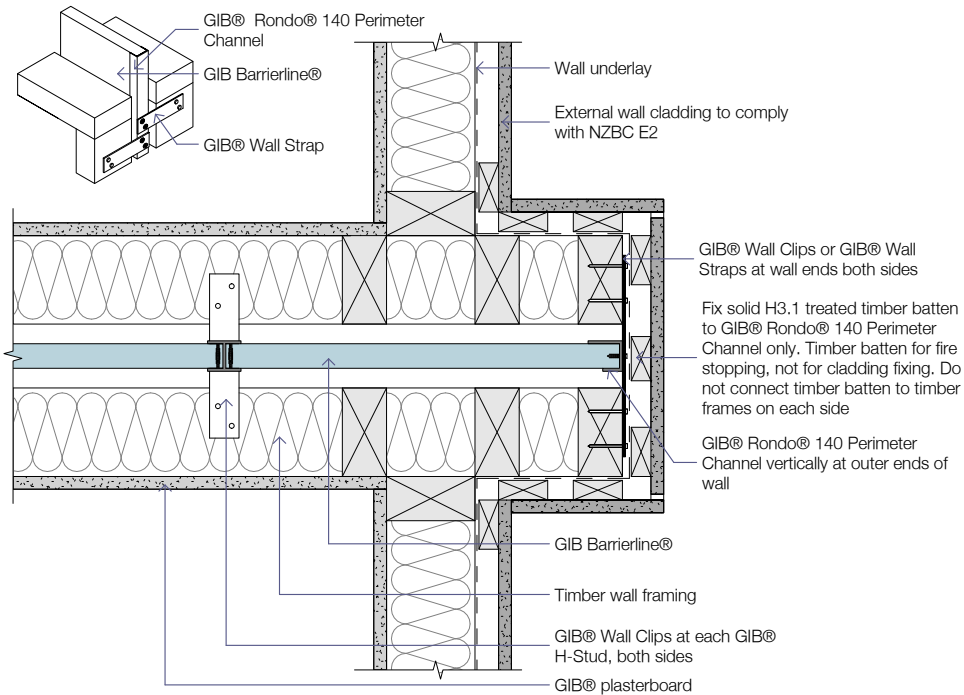

GNS104

DETAIL AT CEILING AND ROOF (END ELEVATION)

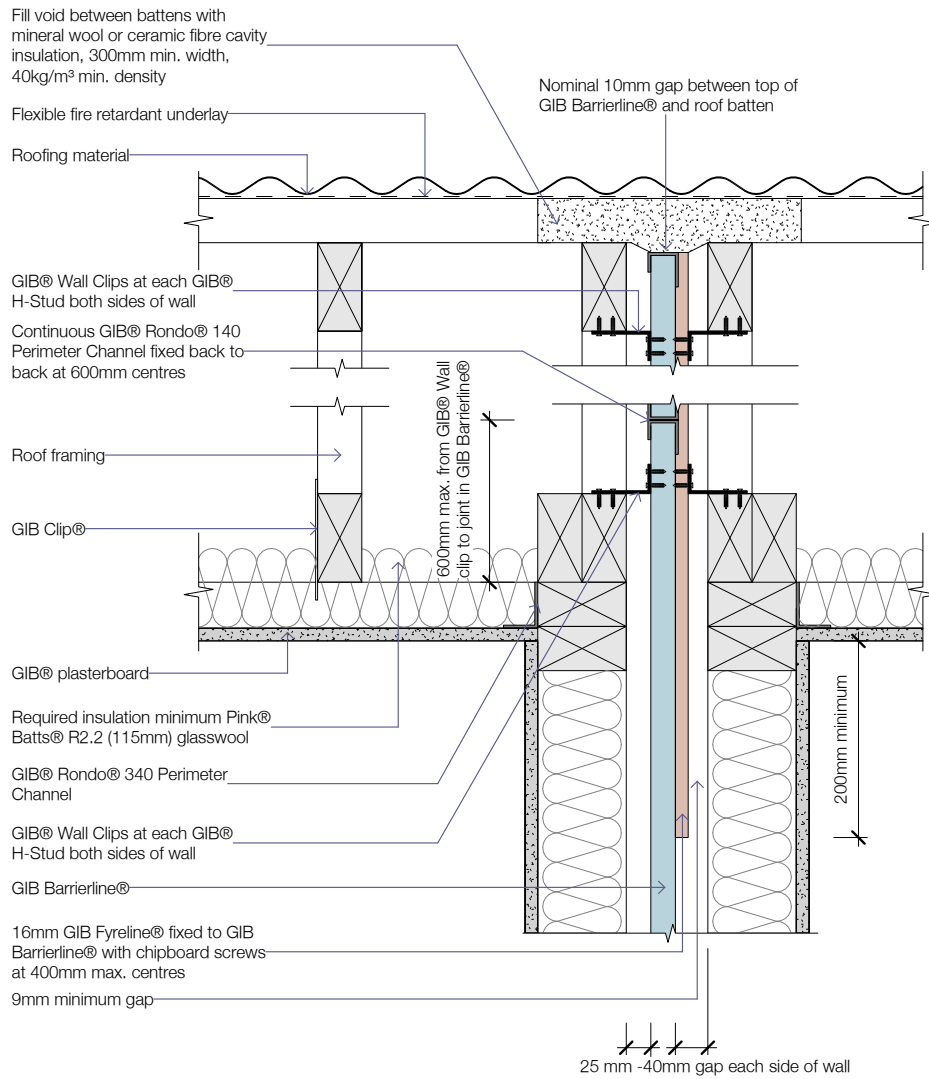

GNS105

DETAIL AT RETURN IN EXTERNAL BRICK VENEER WALL (PLAN VIEW)

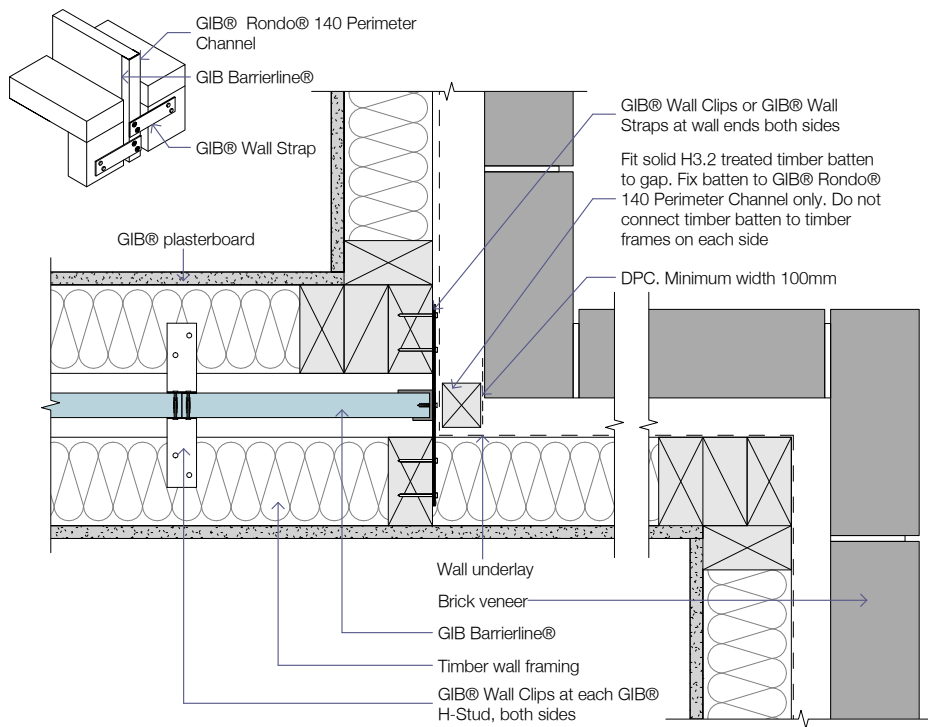

GNS106

DETAIL AT EXTERNAL BRICK VENEER WALL (PLAN VIEW)

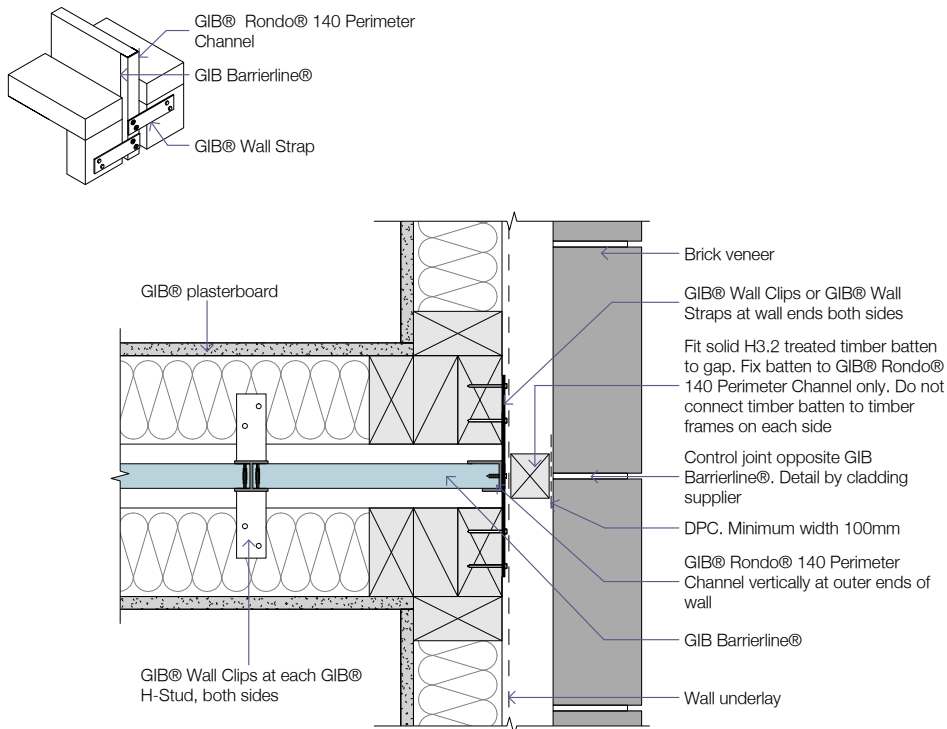

GNS107

DETAIL AT ROOF/CEILING (END ELEVATION)

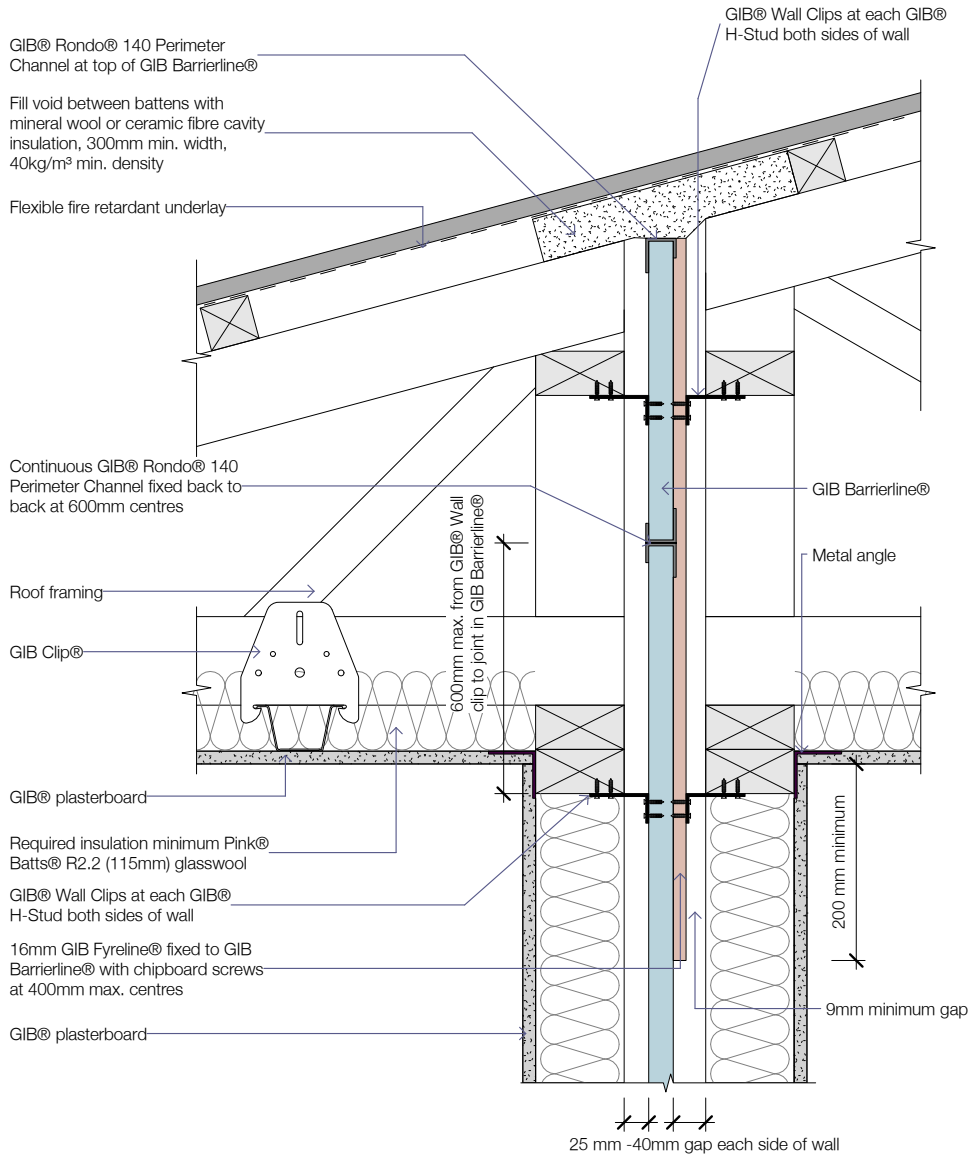

GNS108

DETAIL AT ROOF/CEILING AND PARAPET (END ELEVATION)

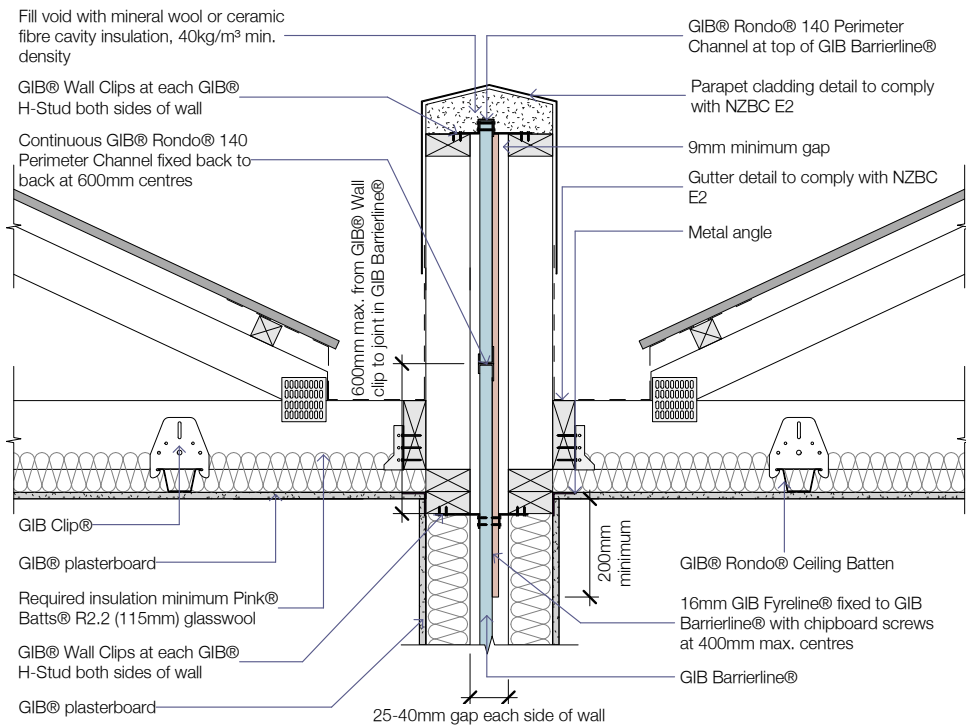

GNS109

DETAIL FOR JUNCTION WITH NON FIRE-RATED WALL (PLAN VIEW)

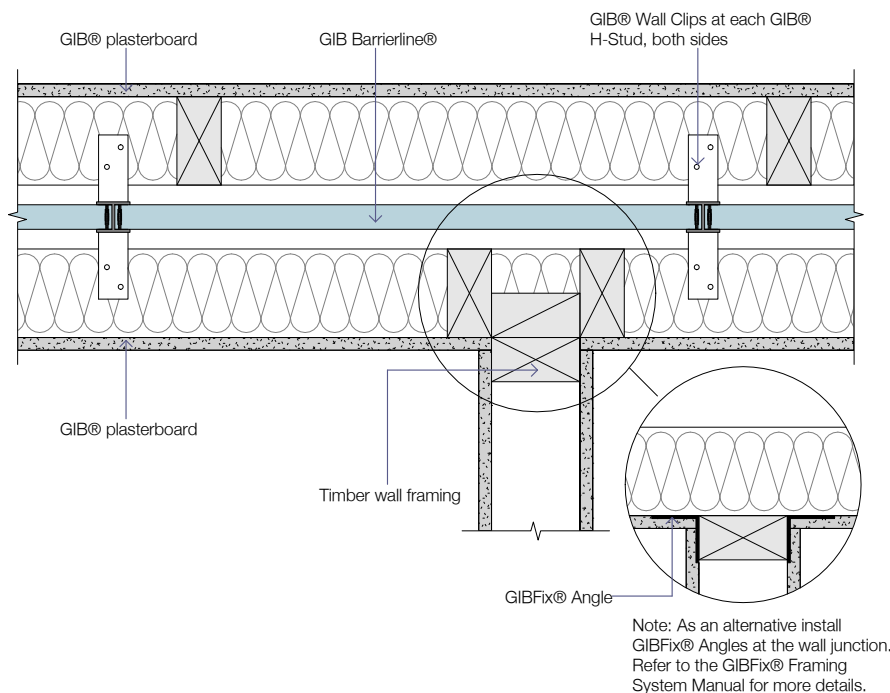

GNS110

FIXING DETAIL FOR 16MM GIB FYRELINE®

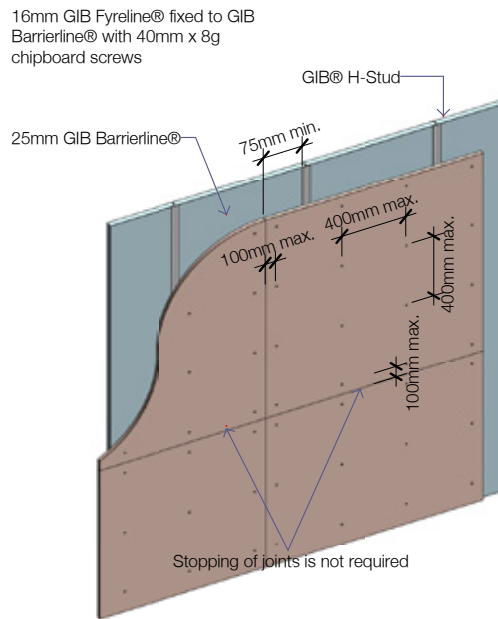

GNS111

ROOF VOID DETAIL WITH HORIZONTAL SHEETING (SIDE ELEVATION)

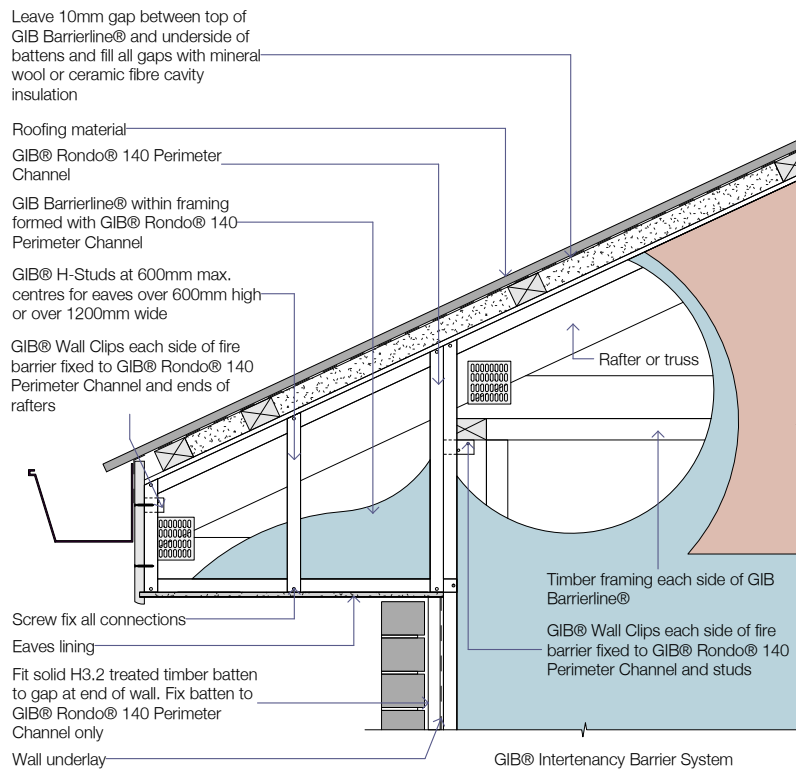

GNS112

ROOF VOID DETAIL WITH HORIZONTAL SHEETING (SIDE ELEVATION)

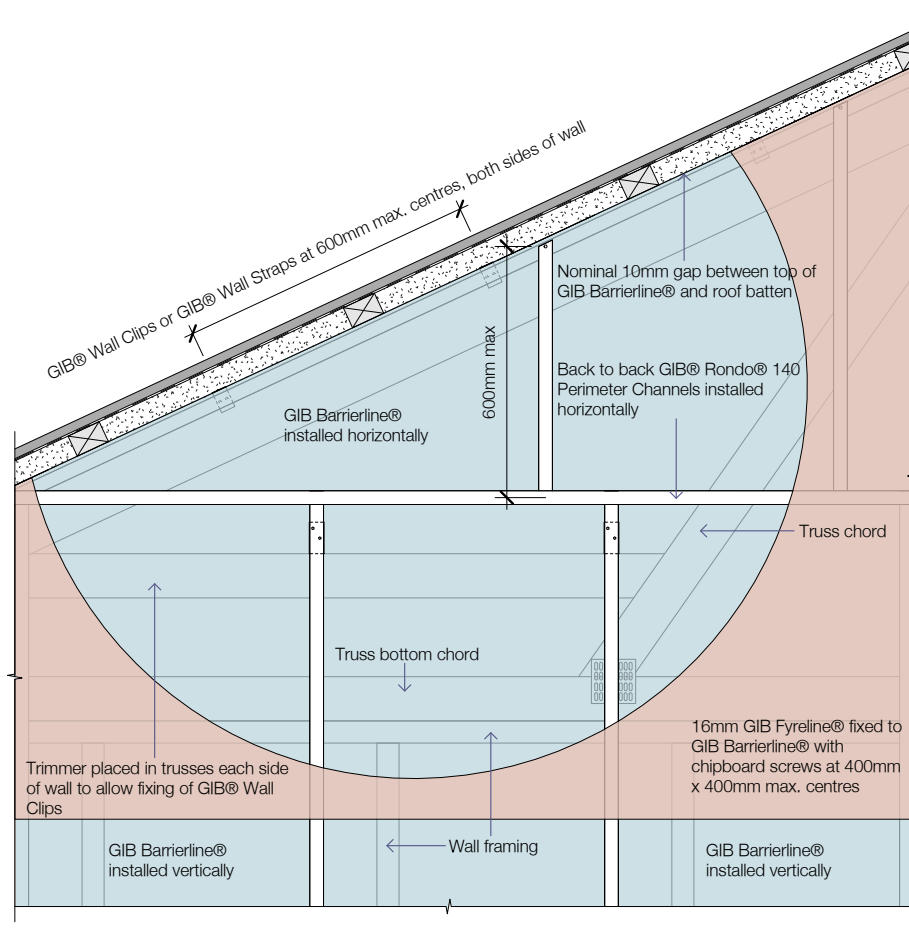

GNS113

STEEL FRAME GIB BARRIERLINE® WALL CORNER

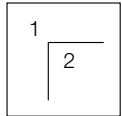

Unit layout

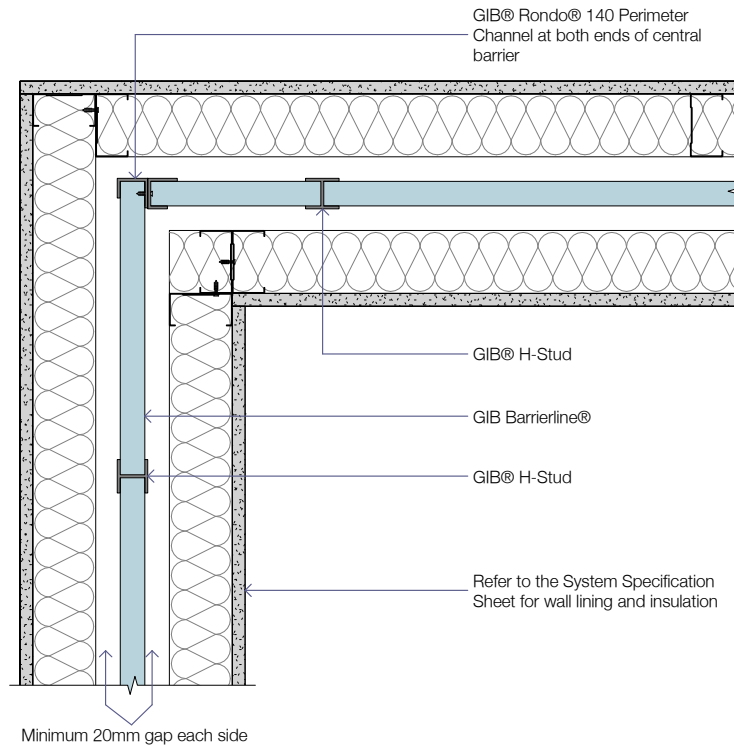

GNS140

STEEL FRAME GIB BARRIERLINE® WALL TO SINGLE STEEL FRAME WALL

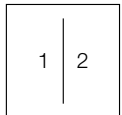

Unit layout

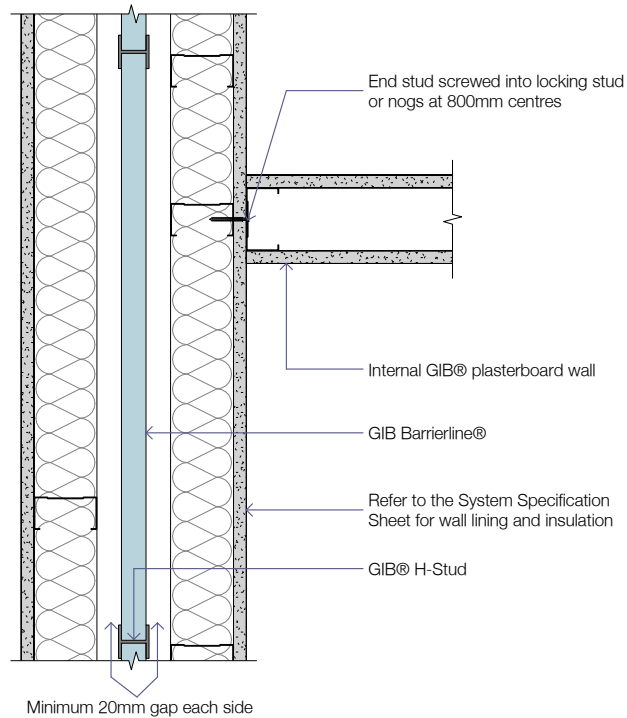

GNS141

STEEL FRAME GIB BARRIERLINE® WALL TO CONCRETE OR FILLED MASONRY

1
2

Unit layout

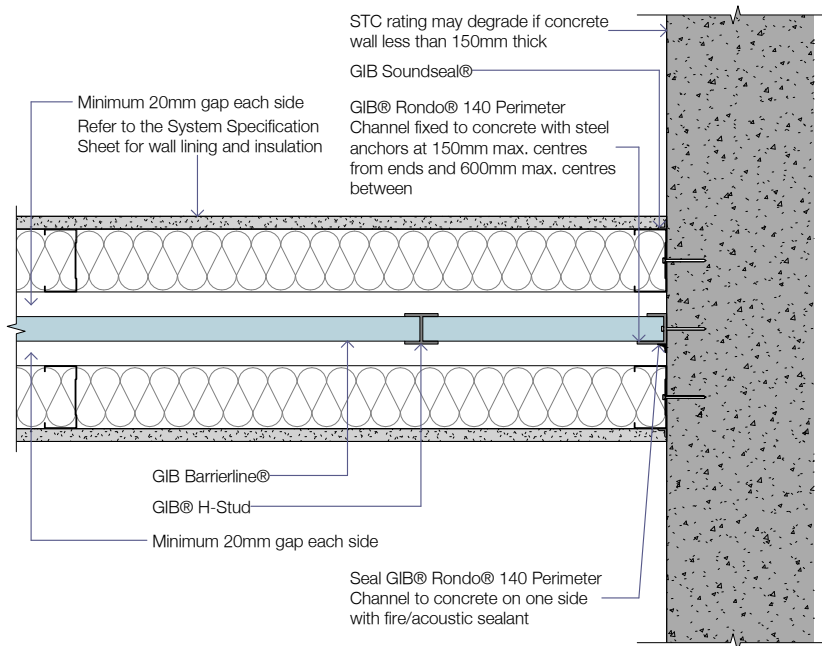

GNS142

STEEL FRAME GIB BARRIERLINE® WALL TO EXTERNAL WALL

1
2

Unit layout

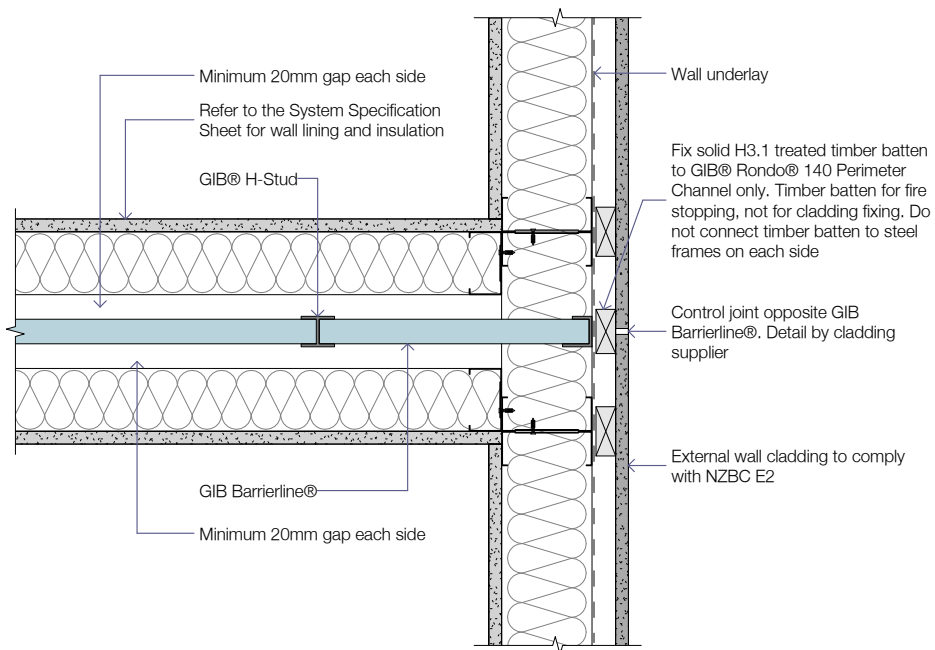

GNS143

STEEL FRAME GIB BARRIERLINE® WALL BASE DETAIL AT SLAB

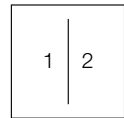

Unit layout

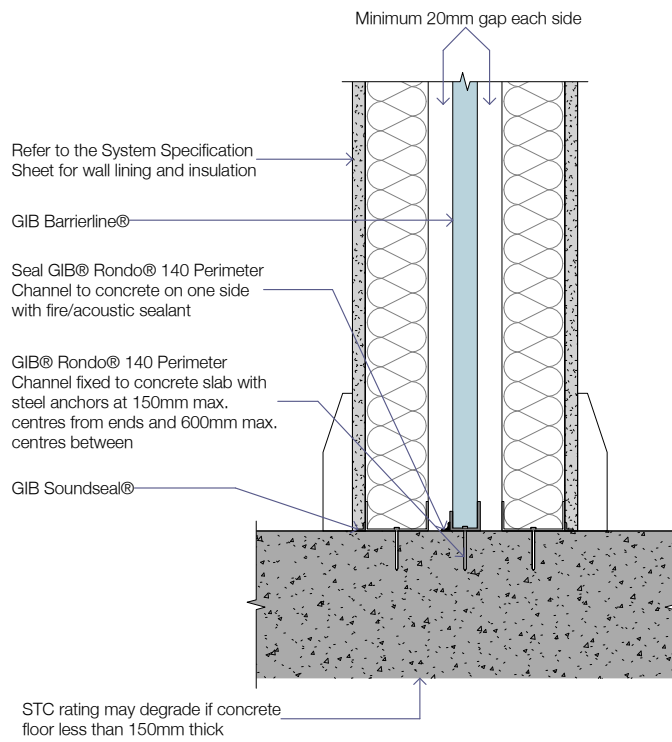

GNS144

STEEL FRAME GIB BARRIERLINE® WALL SUSPENDED SLAB HEAD DETAIL

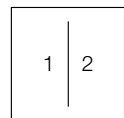

Unit layout

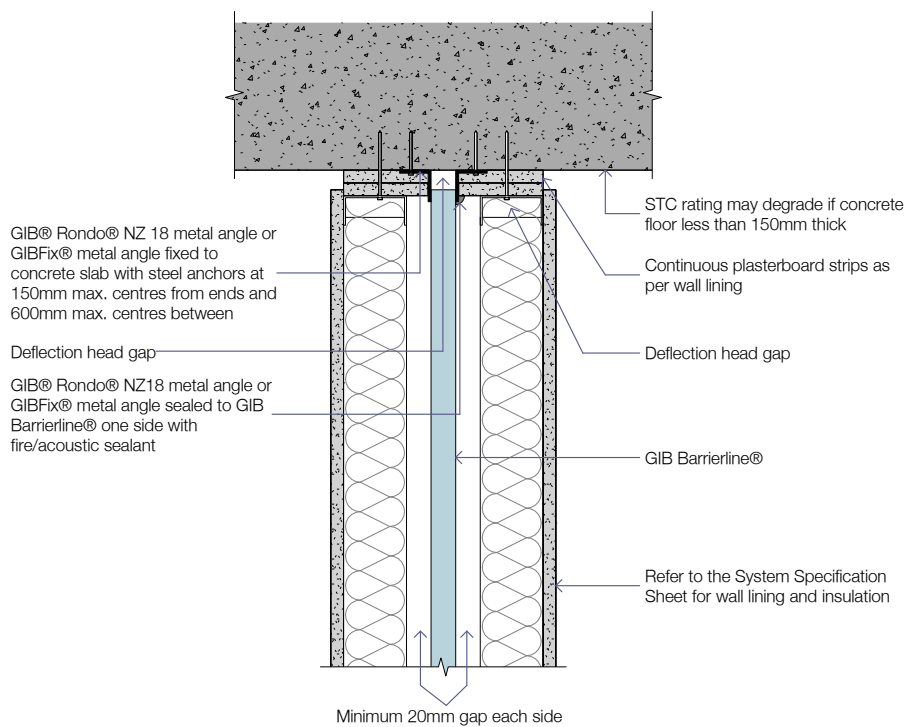

GNS145

STEEL FRAME GIB BARRIERLINE® WALL SUSPENDED SLAB HEAD DETAIL (OVER 3000MM WALL HEIGHT)

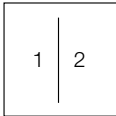

Unit layout

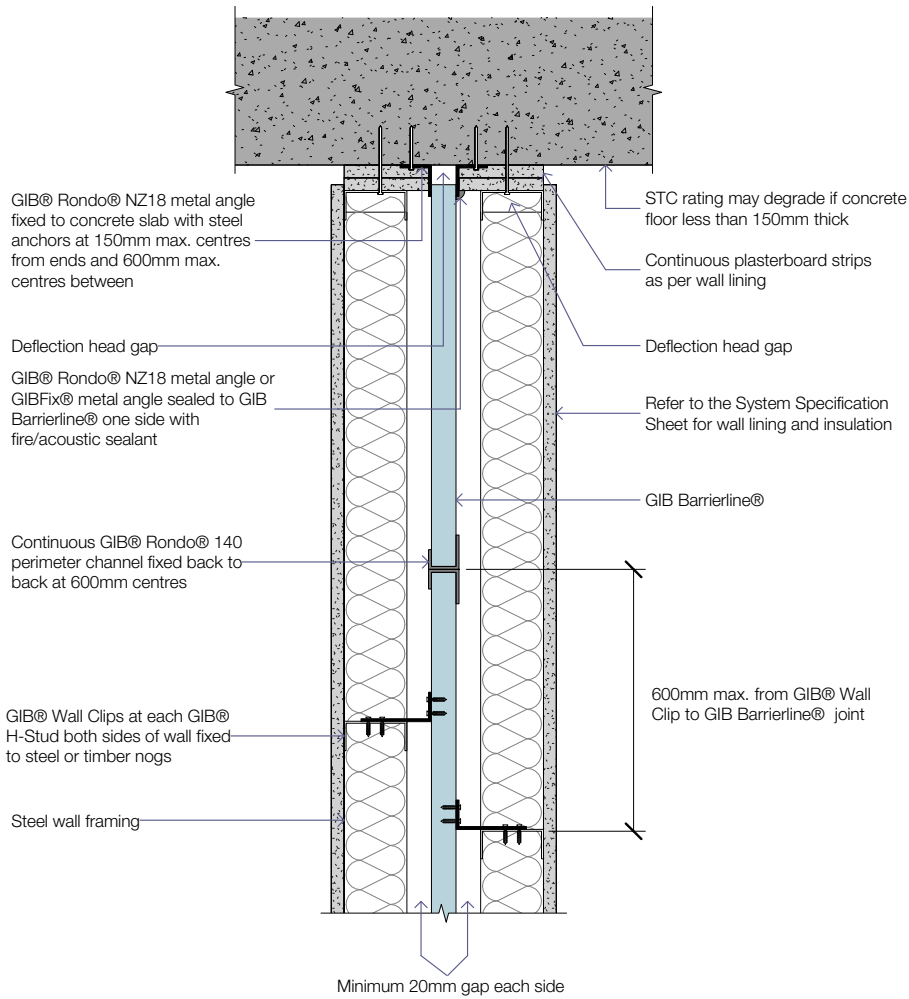

GNS146

STAGGERED STUD STEEL FRAME BARRIER WALL CORNER

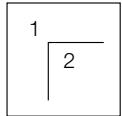

Unit layout

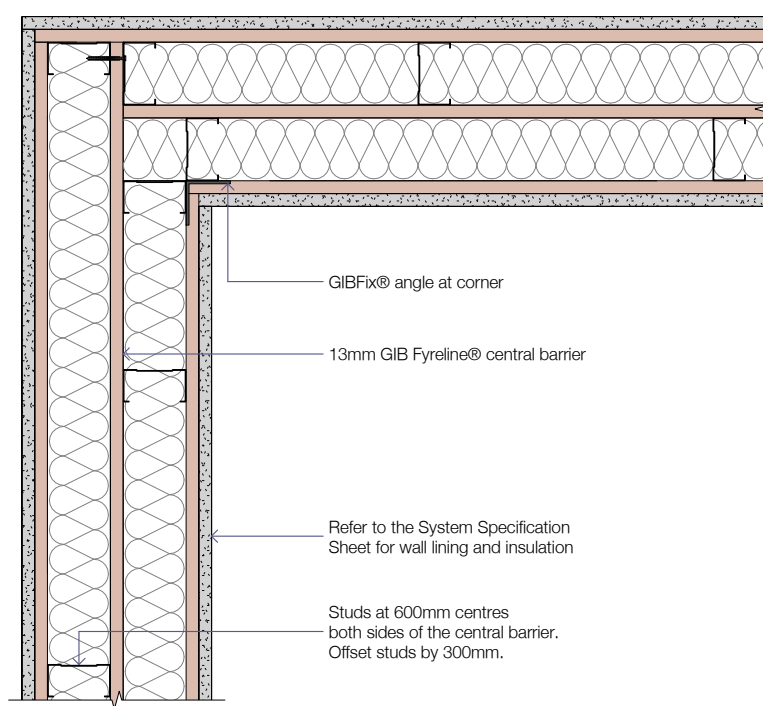

GNS180

STAGGERED STUD STEEL FRAME BARRIER WALL TO SINGLE STEEL FRAME BARRIER WALL

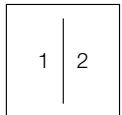

Unit layout

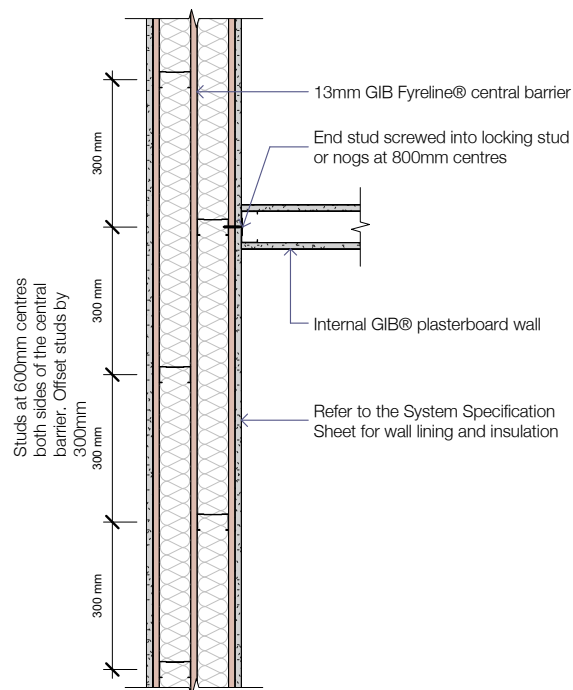

GNS181

STAGGERED STUD STEEL FRAME BARRIER WALL TO CONCRETE OR FILLED MASONRY

1
2

Unit layout

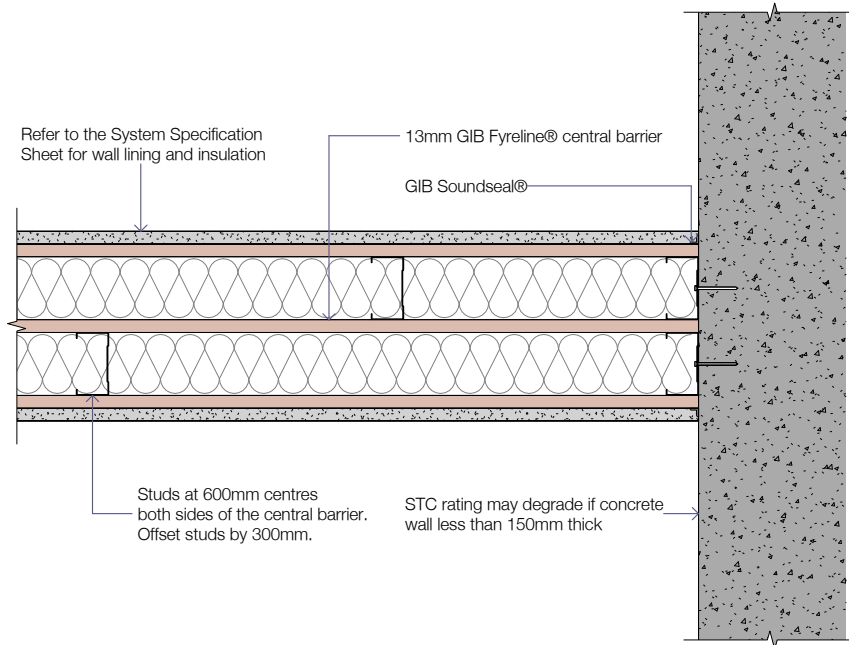

GNS182

STAGGERED STUD STEEL FRAME BARRIER WALL TO EXTERNAL WALL

1
2

Unit layout

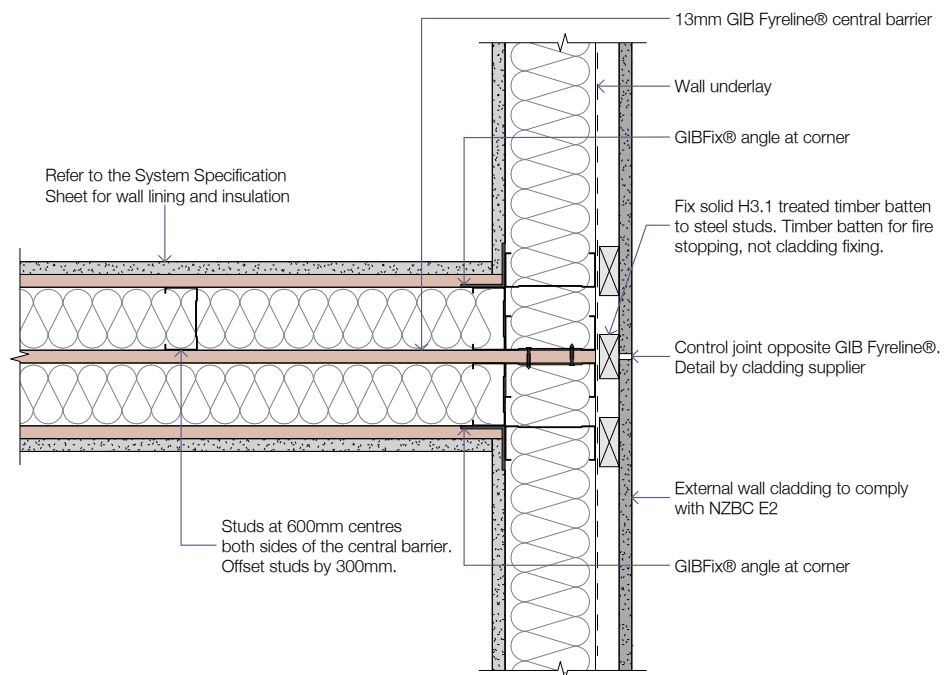

GNS183

STAGGERED STUD STEEL FRAME BARRIER WALL BASE DETAIL AT SLAB

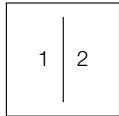

Unit layout

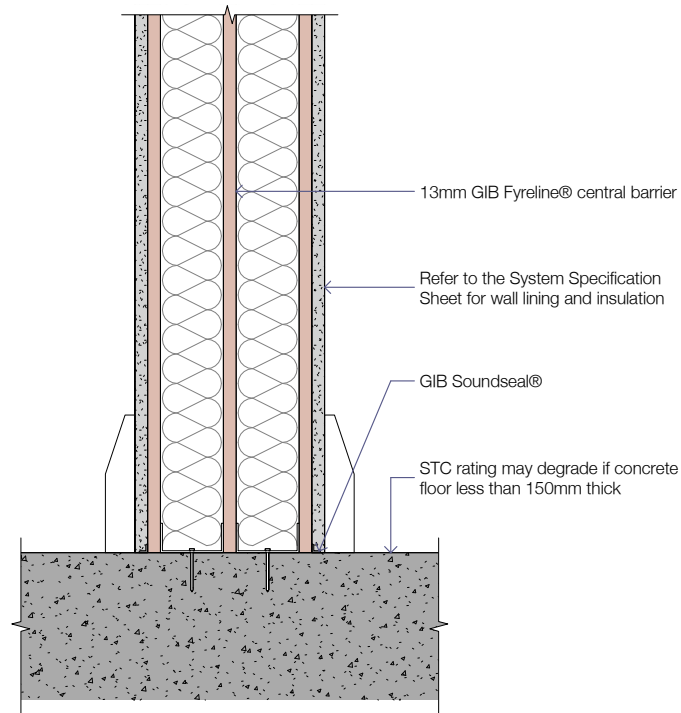

GNS184

STAGGERED STUD STEEL FRAME BARRIER WALL TO SUSPENDED SLAB HEAD DETAIL

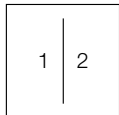

Unit layout

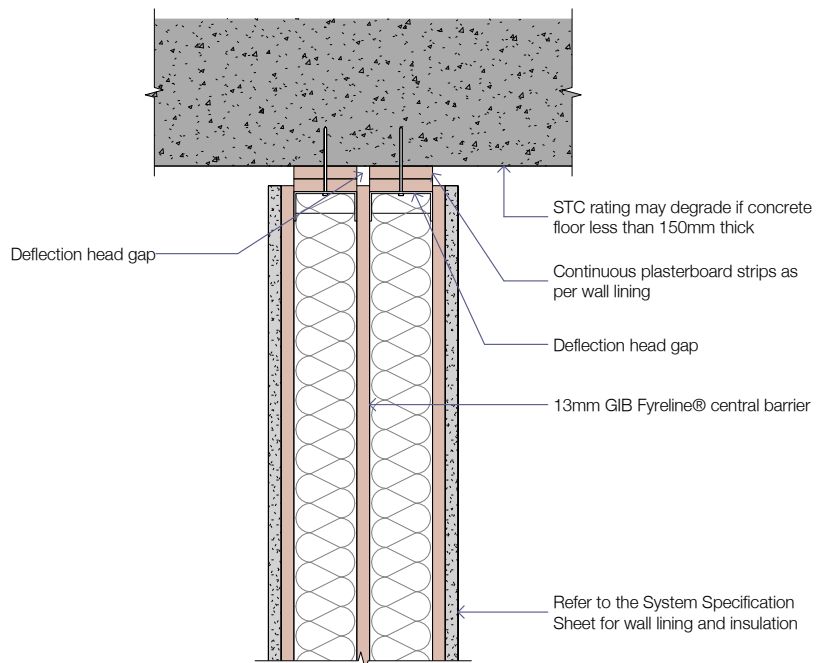

GNS185

DOUBLE TIMBER FRAME WALL TO EXTERNAL WALL

1
2

Unit layout

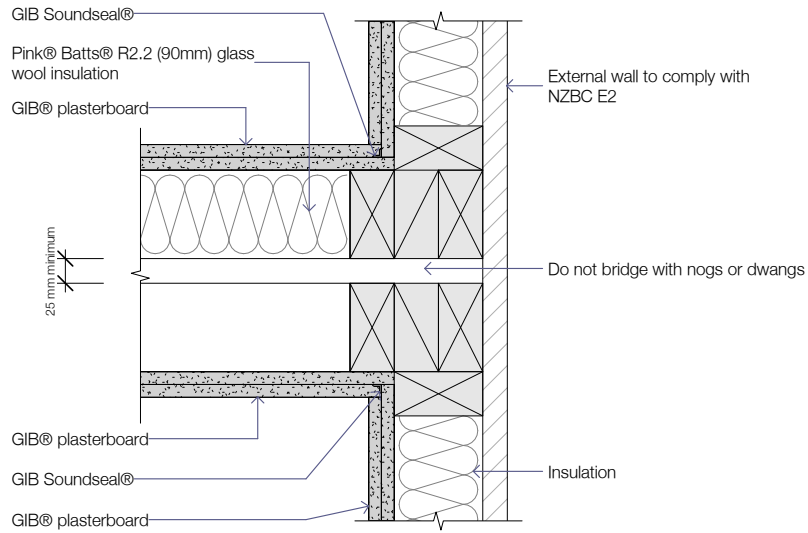

GNS200

DOUBLE TIMBER FRAME WALL TO DOUBLE TIMBER FRAME WALL

1	3
2	

Unit layout

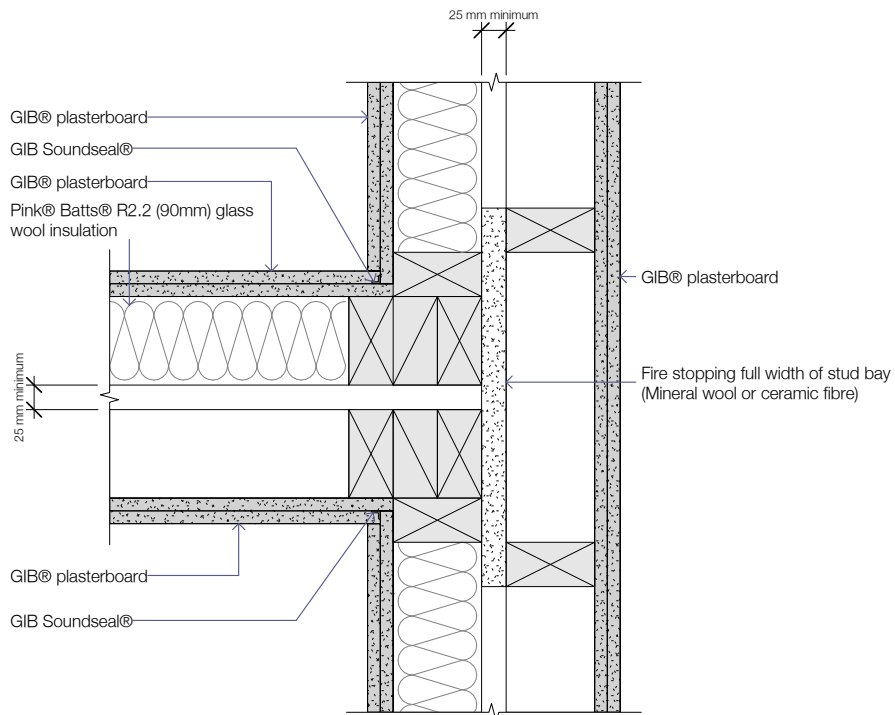

GNS201

SINGLE TIMBER FRAME WALL TO DOUBLE TIMBER FRAME WALL

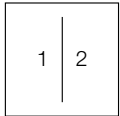

Unit layout

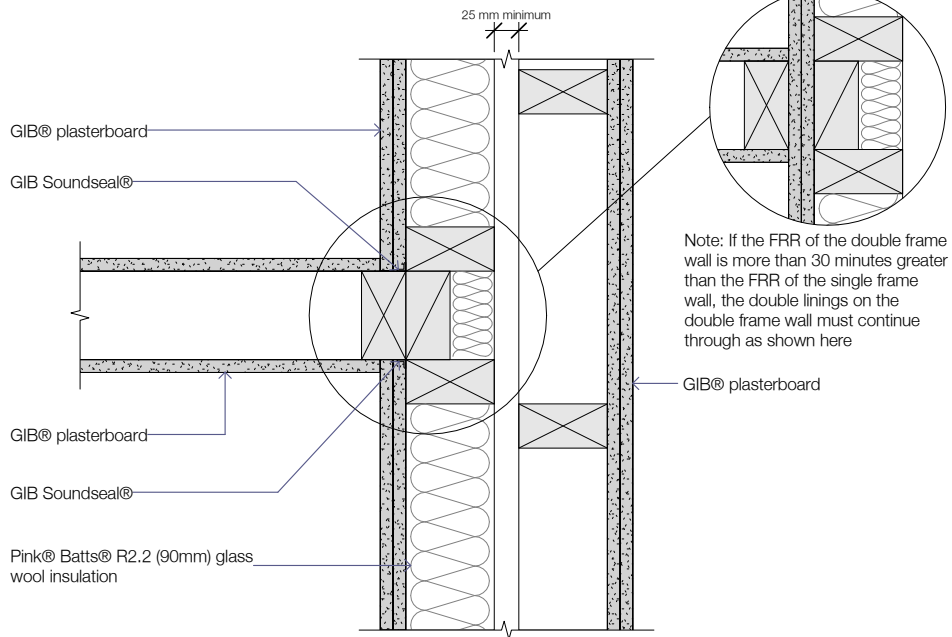

GNS202

DOUBLE JUNCTION SINGLE TIMBER FRAMES TO DOUBLE TIMBER FRAME WALL

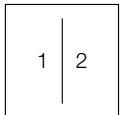

Unit layout

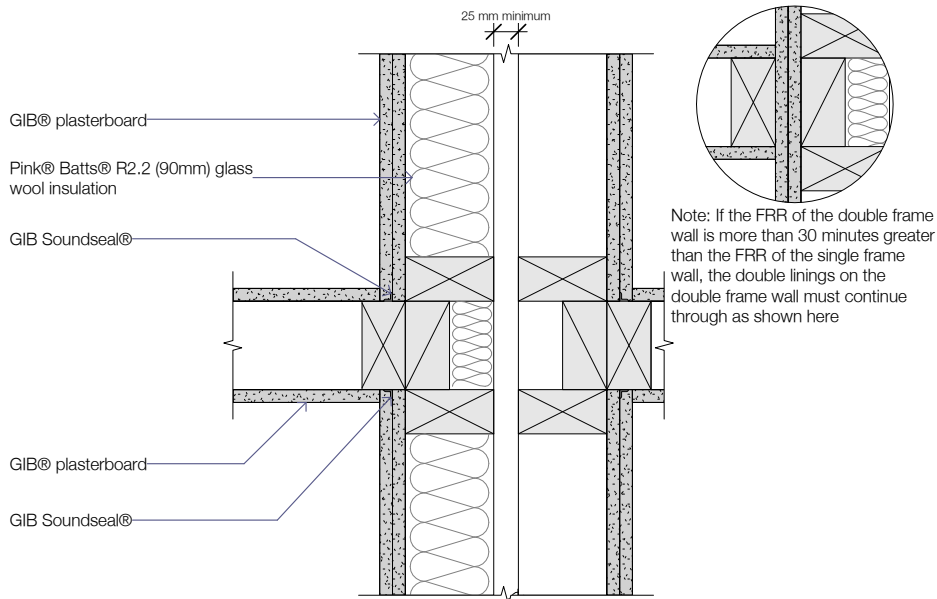

GNS203

DOUBLE TIMBER FRAME WALL INTERNAL/EXTERNAL CORNER

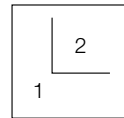

Unit layout

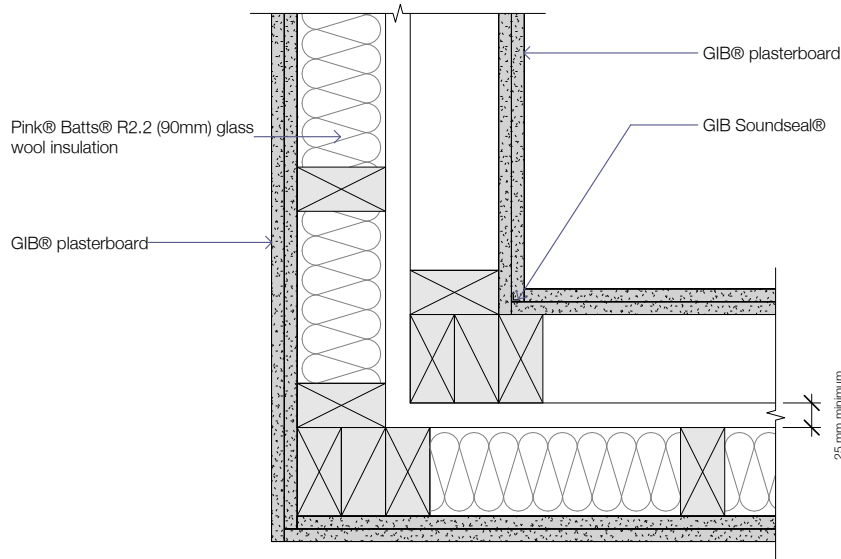

GNS204

DOUBLE TIMBER FRAME WALL DEFLECTION HEAD DETAIL

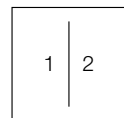

Unit layout

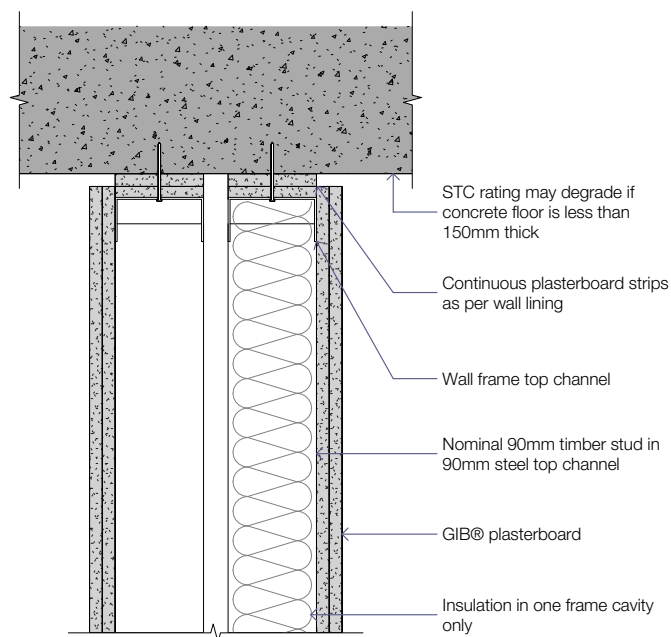

GNS205

DOUBLE STEEL FRAME WALL TO CONCRETE OR FILLED MASONRY

1	
2	

Unit layout

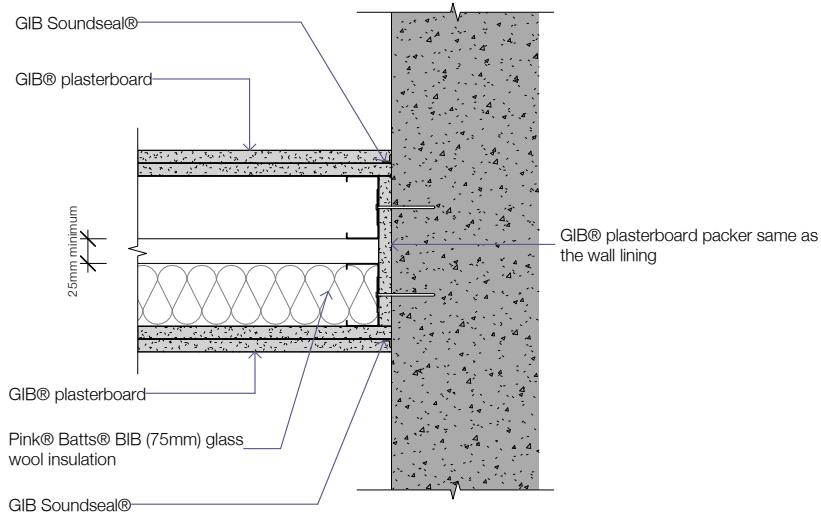

GNS220

DOUBLE STEEL FRAME WALL TO DOUBLE STEEL FRAME WALL

1		3
2		

Unit layout

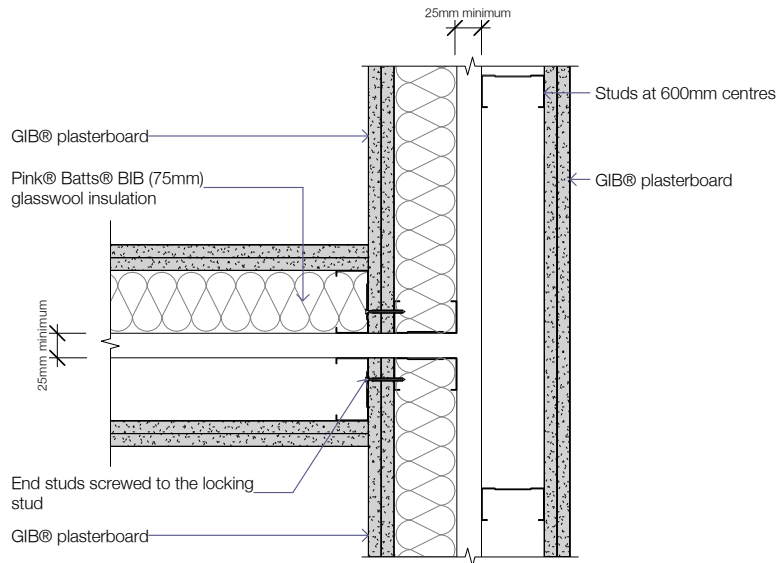

GNS221

DOUBLE STEEL FRAME WALL DEFLECTION HEAD DETAIL

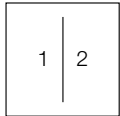

Unit layout

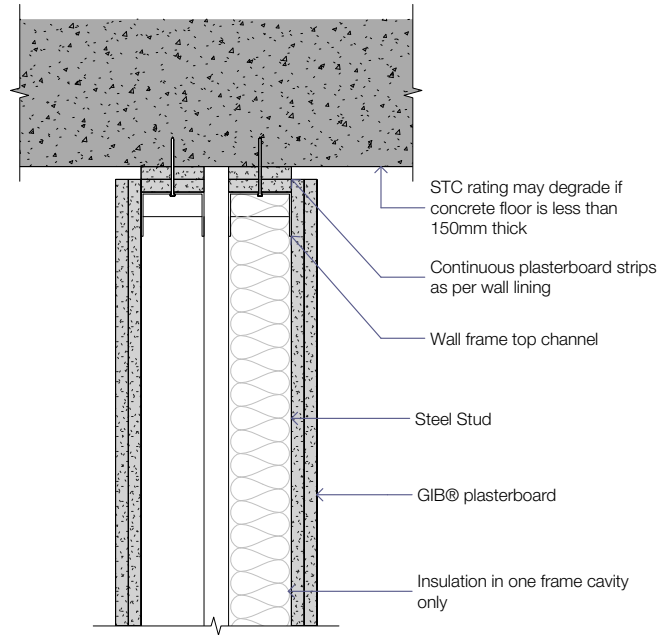

GNS222

SINGLE STEEL FRAME WALL TO DOUBLE STEEL FRAME WALL

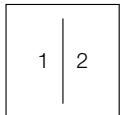

Unit layout

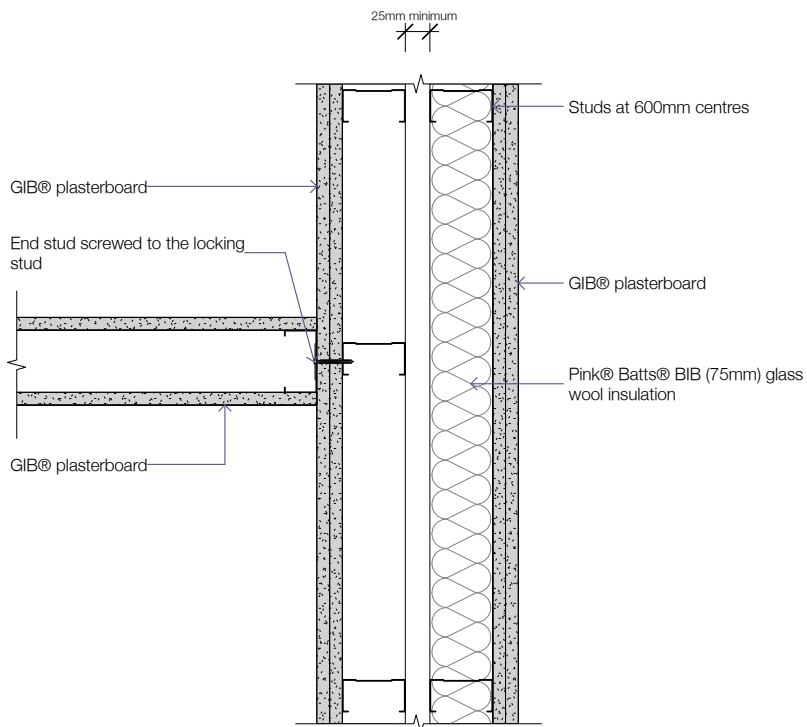

GNS223

SINGLE TIMBER FRAME/GIB RAIL® WALL INTERNAL CORNER

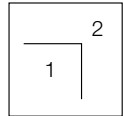

Unit layout

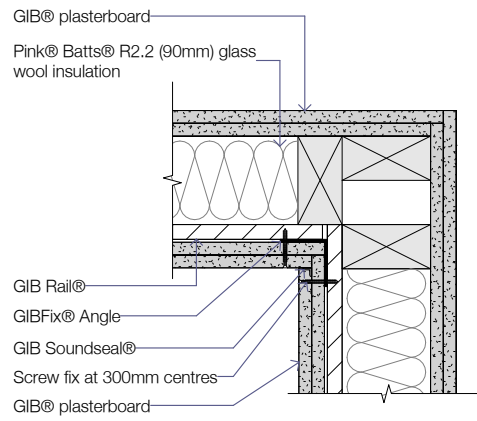

GNS240

SINGLE TIMBER FRAME/GIB RAIL® WALL EXTERNAL CORNER

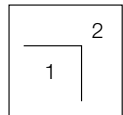

Unit layout

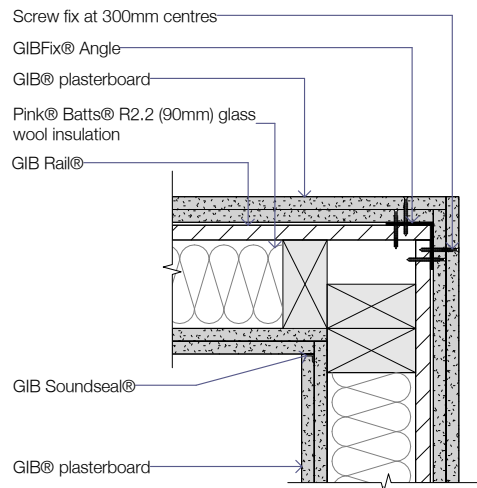

GNS241

SINGLE TIMBER FRAME WALL TO SINGLE TIMBER FRAME/GIB RAIL® WALL

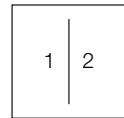

Unit layout

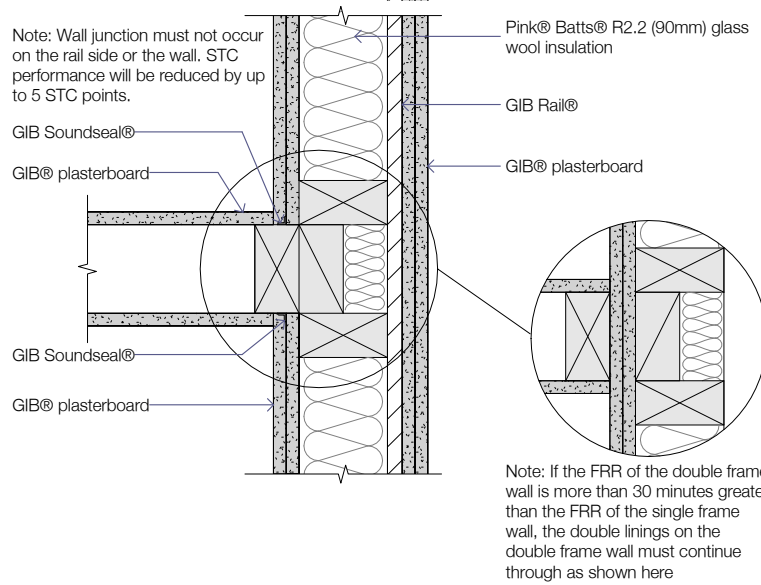

GNS242

SINGLE TIMBER FRAMES TO SINGLE TIMBER/GIB RAIL® WALL

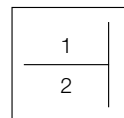

Unit layout

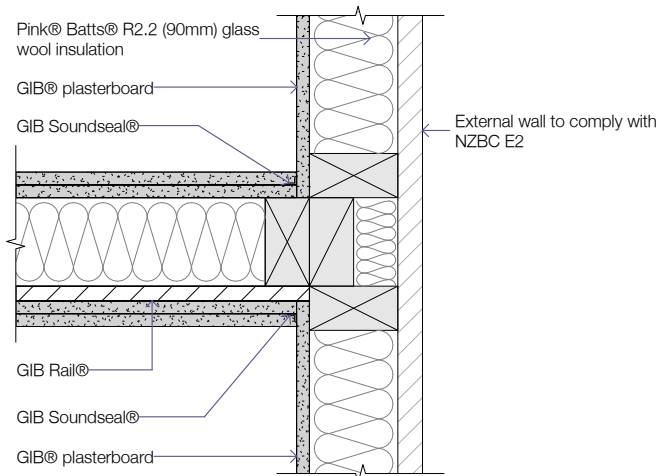

GNS243

SINGLE STEEL FRAMES TO SINGLE STEEL/GIB RAIL® WALL

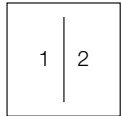

Unit layout

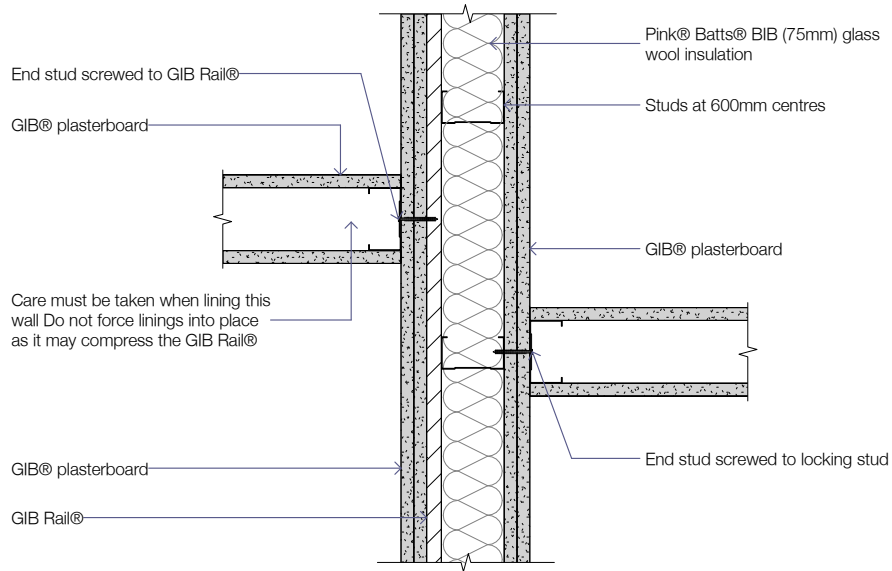

GNS260

SINGLE STEEL FRAME/GIB RAIL® WALL INTERNAL CORNER

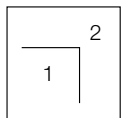

Unit layout

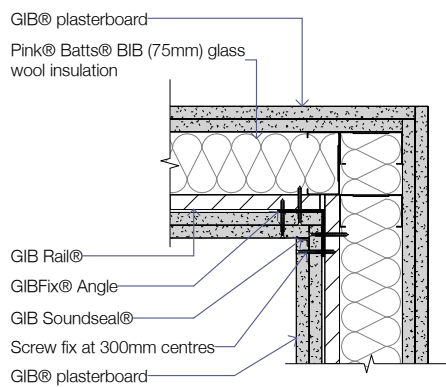

GNS261

SINGLE STEEL FRAME/GIB RAIL® WALL EXTERNAL CORNER

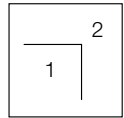

Unit layout

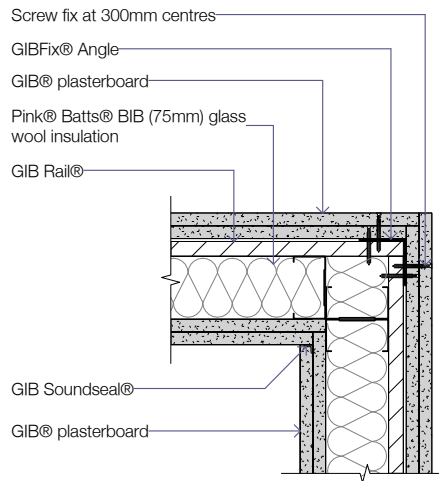

GIB® RONDO® QUIET STUD® T-INTERSECTION

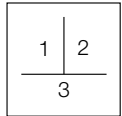

Unit layout

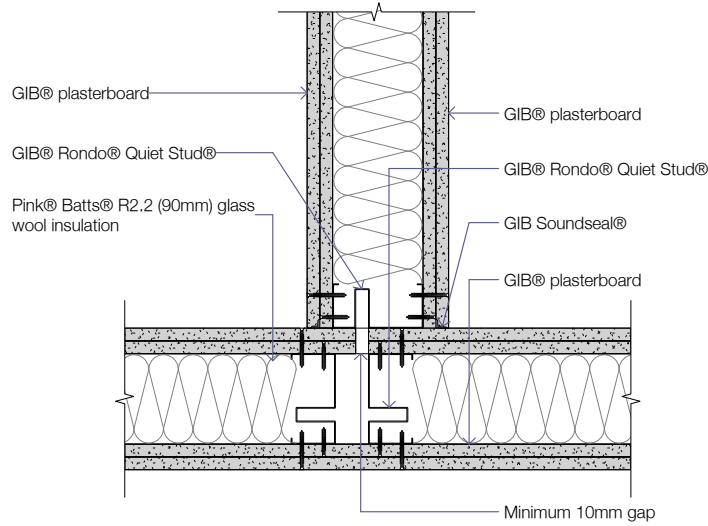

GNS280

GIB® RONDO® QUIET STUD® CORNER

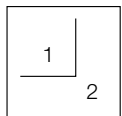

Unit layout

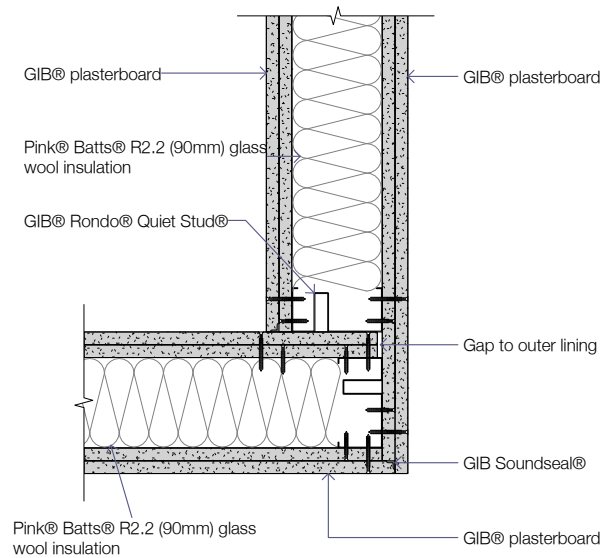

GNS281

GIB® RONDO® QUIET STUD® BOTTOM CHANNEL DETAIL

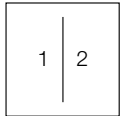

Unit layout

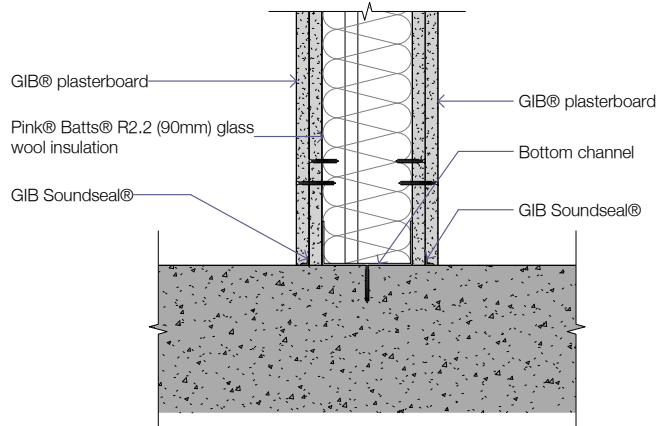

GNS282

GIB® RONDO® QUIET STUD® DEFLECTION HEAD DETAIL

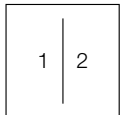

Unit layout

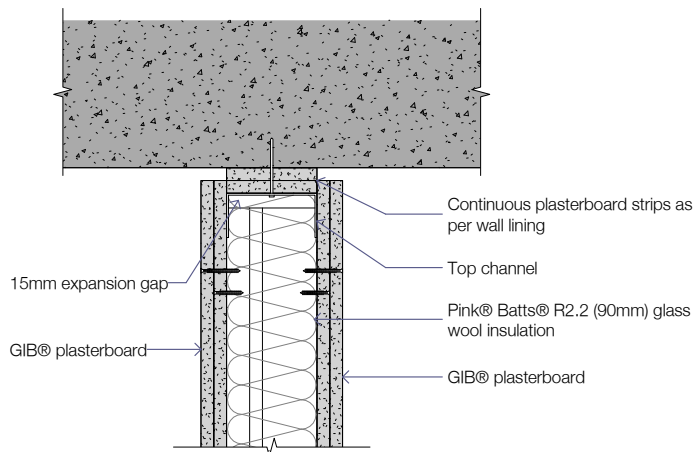

GNS283

STEEL NOG

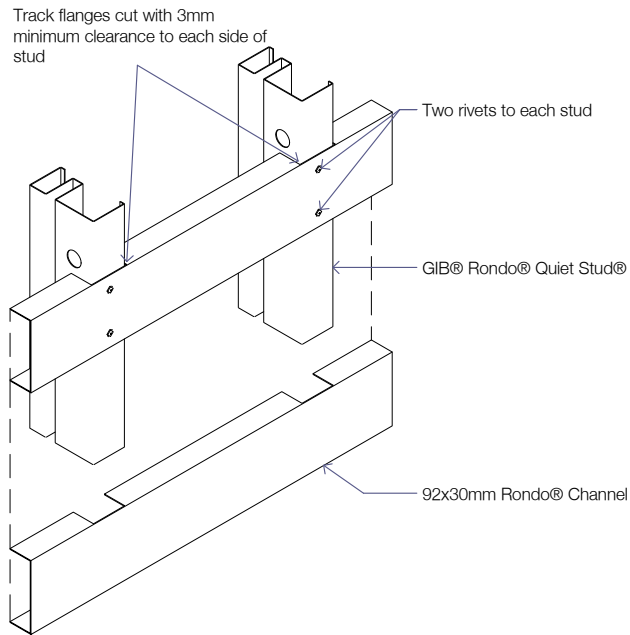

GNS284

TIMBER NOG

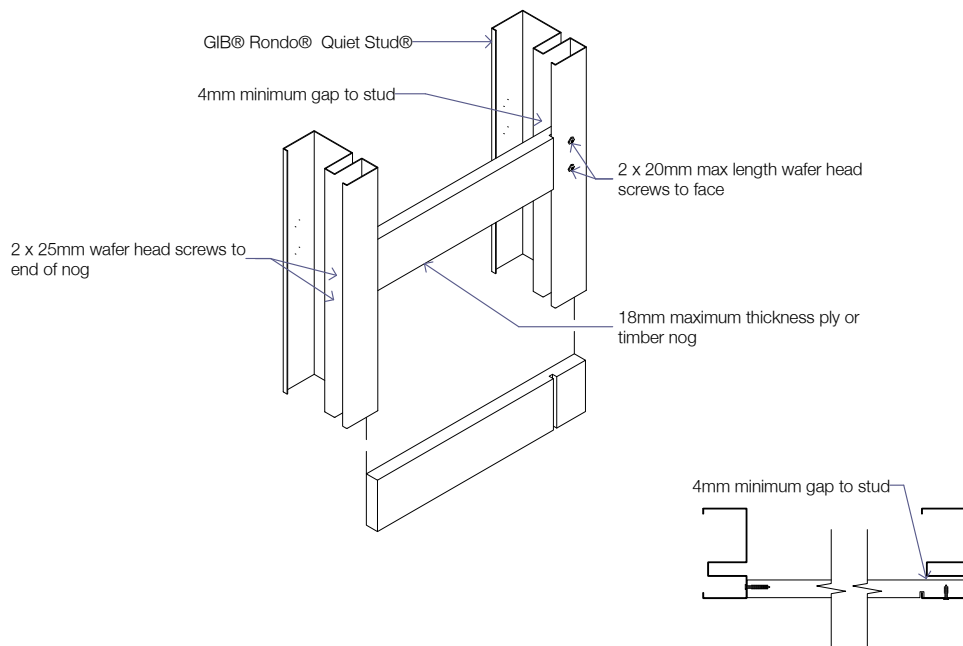

GNS285

GNS286

FLOOR/CEILING WITH BATTENS TO DOUBLE TIMBER FRAME WALL (JOISTS PERPENDICULAR)

1	2
3	4

Unit layout

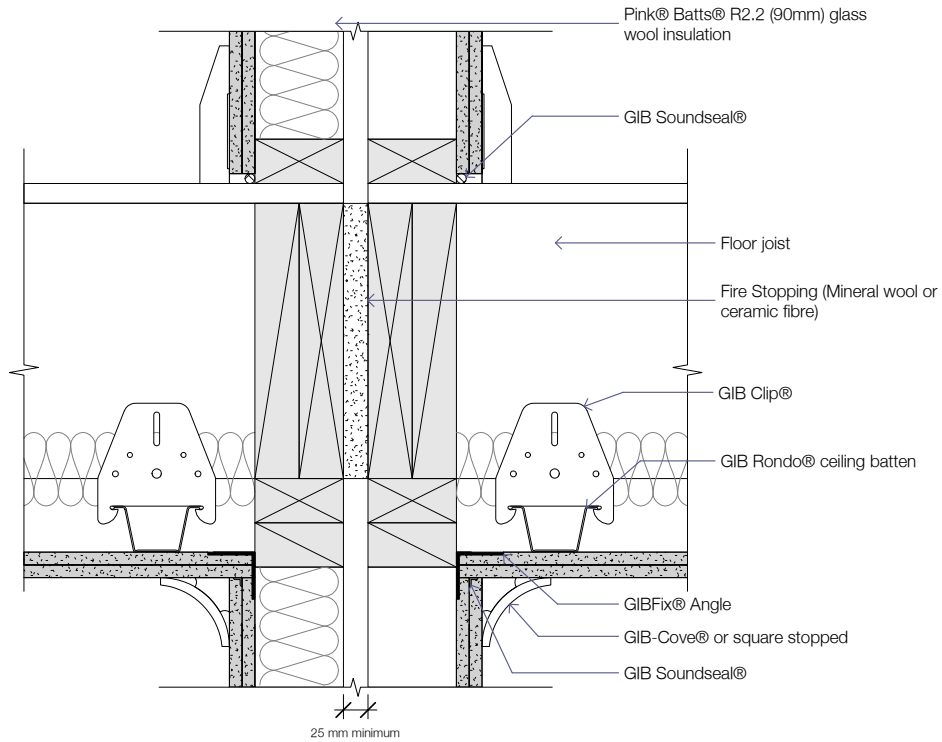

GNS300

FLOOR/CEILING WITH BATTENS TO DOUBLE TIMBER FRAME WALL (JOISTS PARALLEL)

1	2
3	4

Unit layout

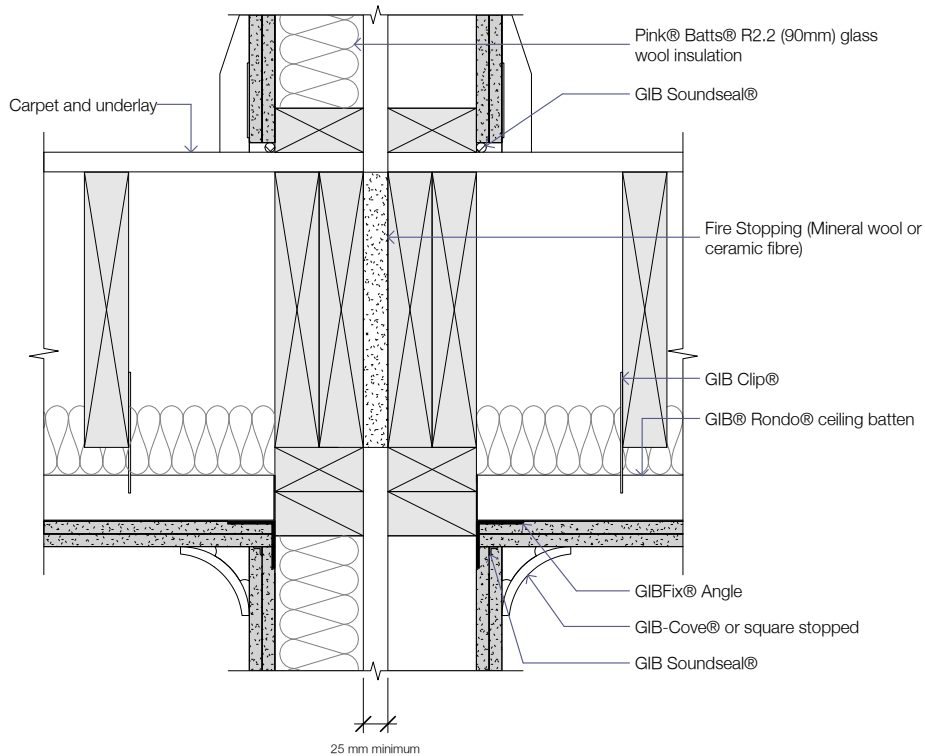

GNS301

FLOOR/CEILING TO DOUBLE TIMBER FRAME WALL (JOISTS PERPENDICULAR)

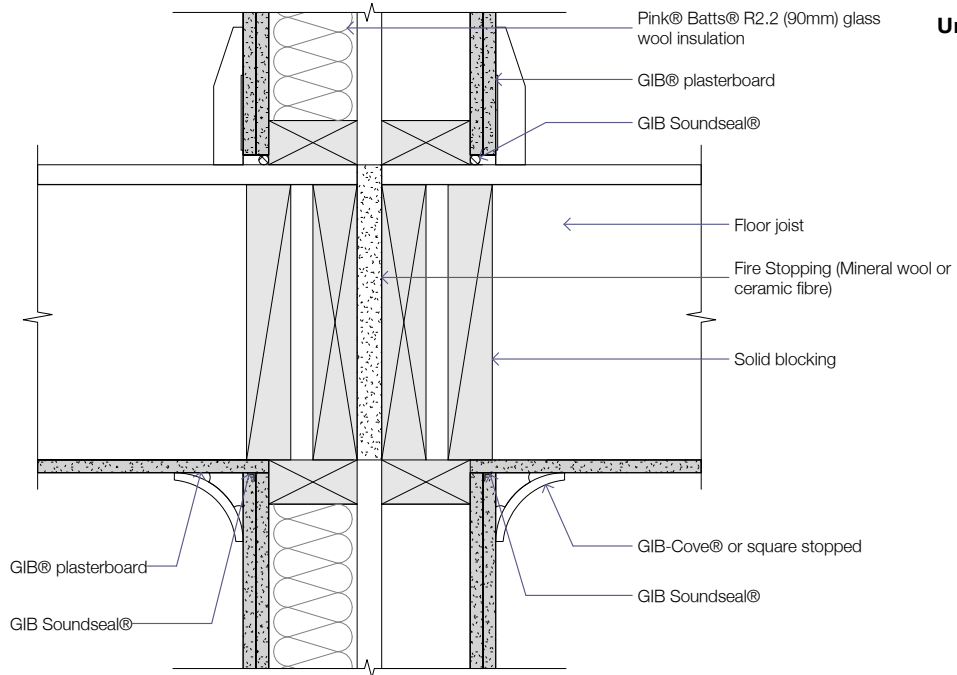
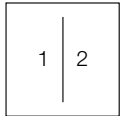

Unit layout

GNS302

FLOOR/CEILING TO DOUBLE TIMBER FRAME WALL (JOISTS PARALLEL)

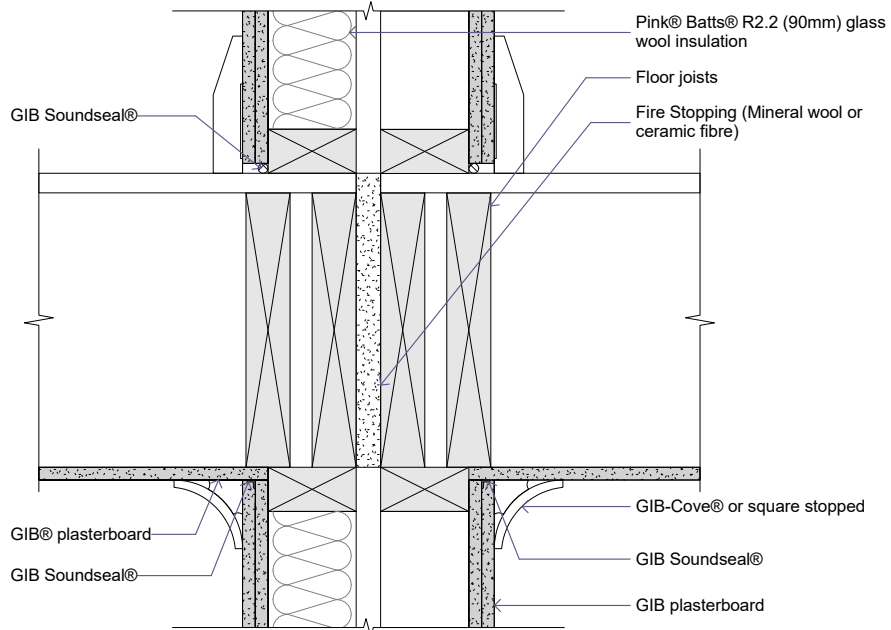
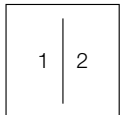

Unit layout

GNS303

SPLIT LEVEL FLOOR/CEILINGS TO DOUBLE TIMBER FRAME WALL

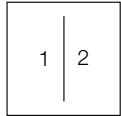

Unit layout

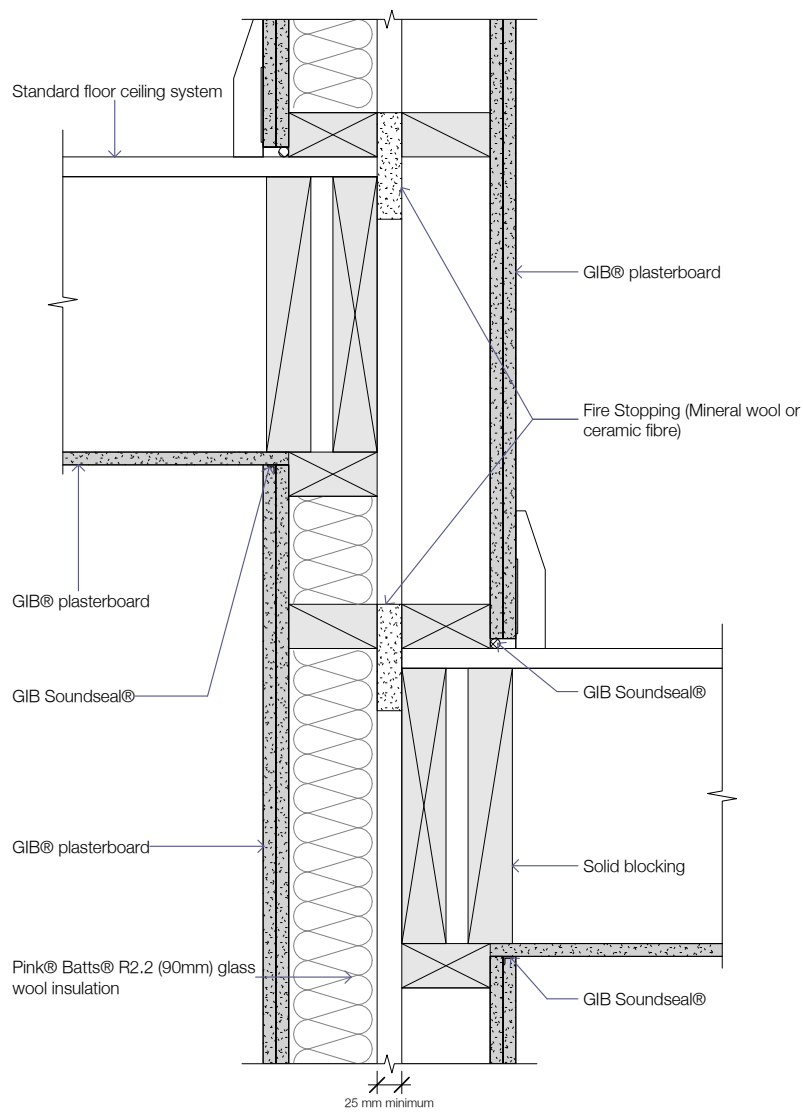

GNS304

FLOOR/CEILING TO EXTERNAL WALL

1
2

Unit layout

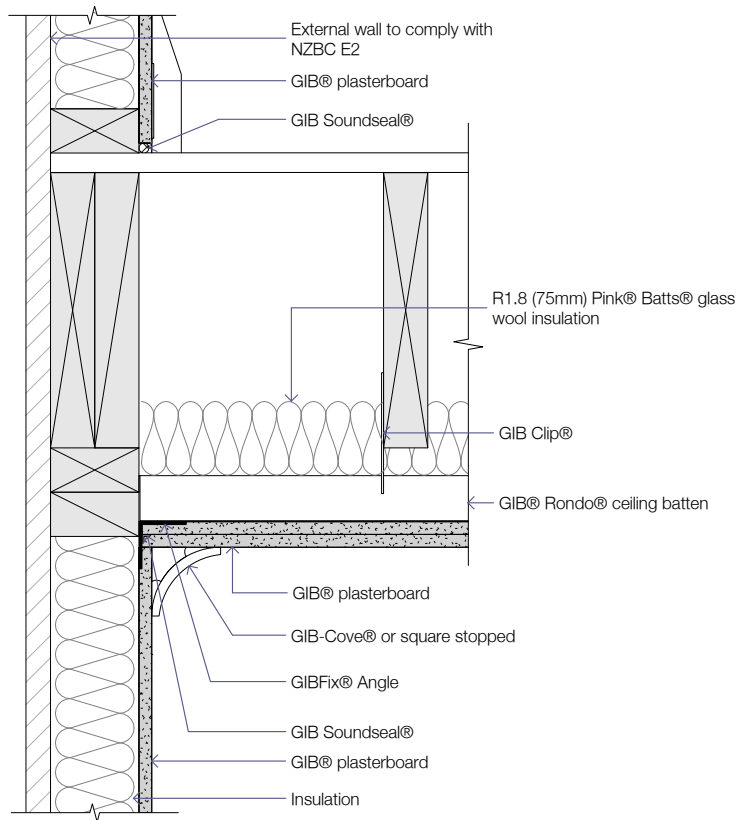

GNS305

SINGLE FRAME FIRE RATED WALL TO ROOF CAVITY

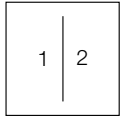

Unit layout

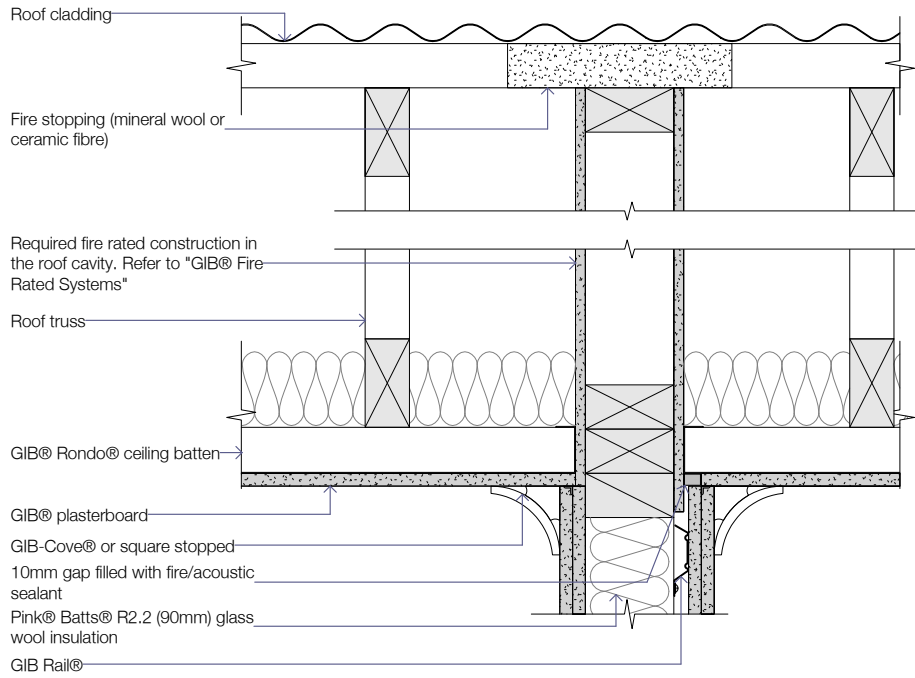

GNS307

DOUBLE FRAME FIRE RATED WALL TO ROOF CAVITY

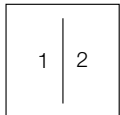

Unit layout

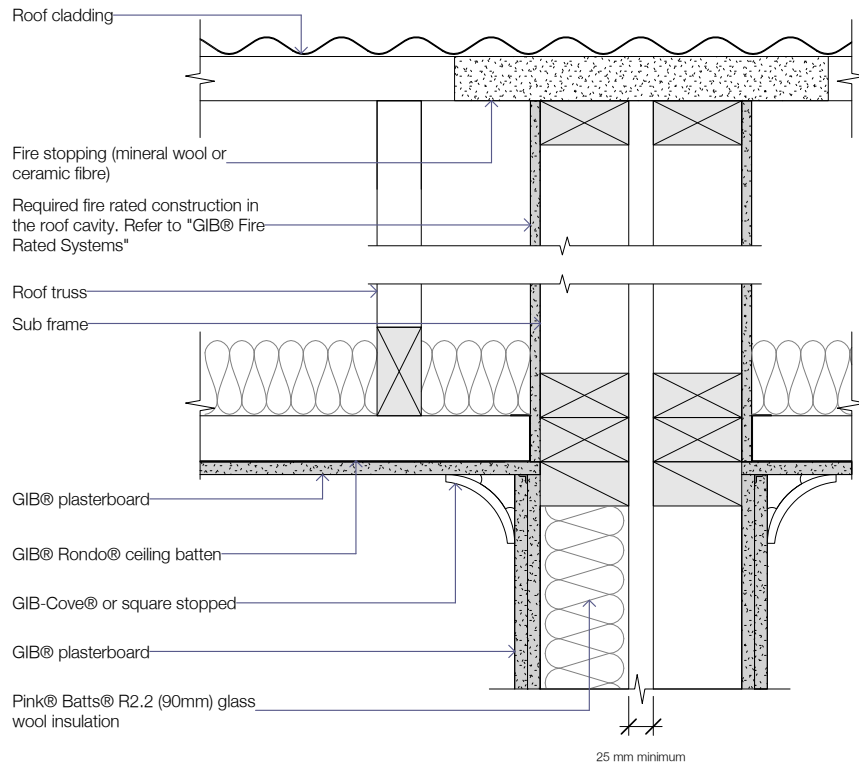

GNS308

GIB BARRIERLINE®

- Glass fibre reinforced core encased in a heavy duty liner board.
- 25mm thickness (approximate mass 20.0kg/m²).
- 3000mm long, 600mm wide.
- Modified core for additional water and mould resistance.
- Square edges.



GIB® STANDARD PLASTERBOARD

- Tapered edges to assist in producing smooth, even and continuous surface once jointed.
- Square edges and square edge/tapered edge available.
- Glass fibre reinforced core.
- 10mm and 13mm thickness (approximate mass 6.5kg/m² and 8.5kg/m²).



GIB BRACELINE®/GIB NOISELINE®

- Dual purpose board that provides high-level bracing performance when used in GIB EzyBrace® Systems and helps reduce noise transmission through walls and ceilings.
- Tapered edges to assist in producing a smooth, even and continuous surface once jointed.
- High density, glass fibre reinforced core.
- 10mm and 13mm thickness (approximate mass 9.0kg/m² and 12.0kg/m²).

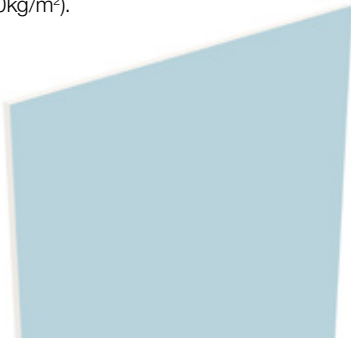

GIB FYRELINE®

- High density modified core resists exposure to fire longer than regular plasterboard.
- Tapered edges to assist in producing a smooth even and continuous surface once jointed.
- 13mm and 16mm thickness (approximate mass 10.5kg/m² and 14.5kg/m²).

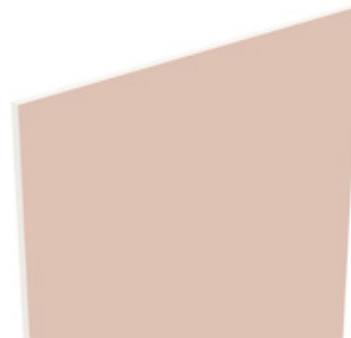

GIB® RONDO® METAL CEILING BATTEN

Forms a strong and stable substrate for ceilings lined with GIB® plasterboard. Compatible with GIB Quiet Clip®.

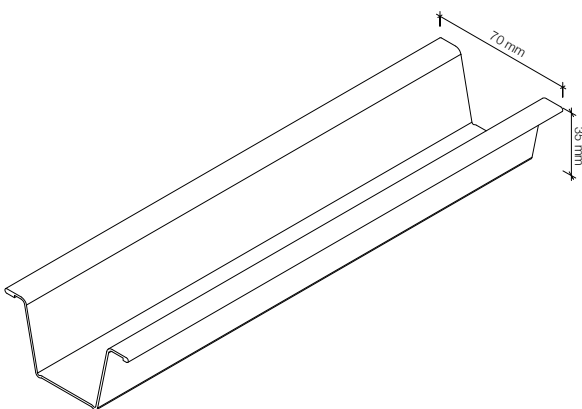

GIB RAIL®

Improves the STC rating of timber and steel single frame walls.

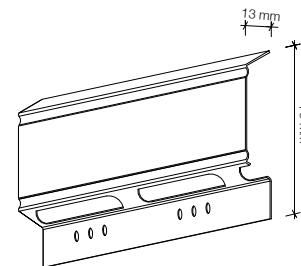

GIB QUIET CLIP®

Provides additional noise attenuation when used in noise control floor/ceiling assemblies. Compatible with GIB® Rondo® metal ceiling batten.

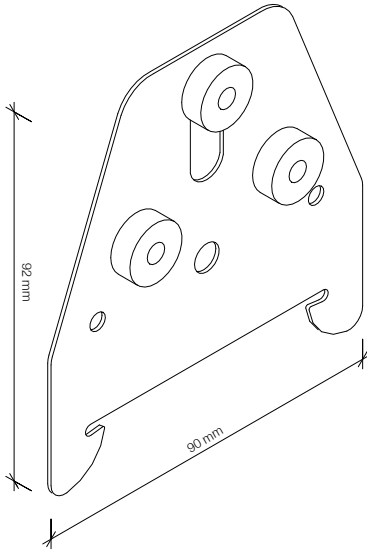

ST-001

Improves the STC rating of timber and steel single frame walls. Compatible with Rondo® 308 and USG FC37 furring channel.

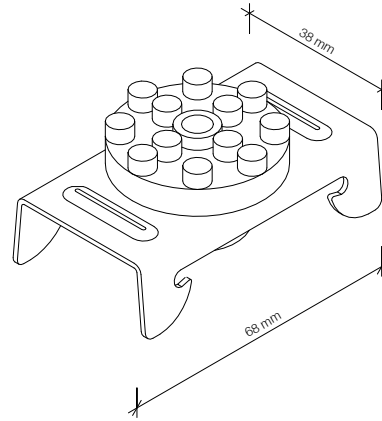

GIB® H-STUD

Supports GIB Barrierline® at all vertical joints.

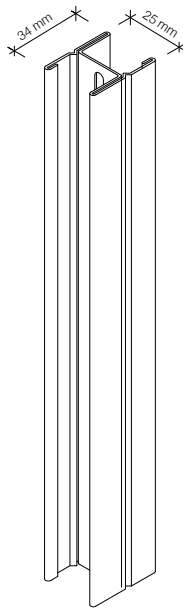

GIB® RONDO® 140 PERIMETER CHANNEL

Supports GIB Barrierline® top and bottom and at wall ends.

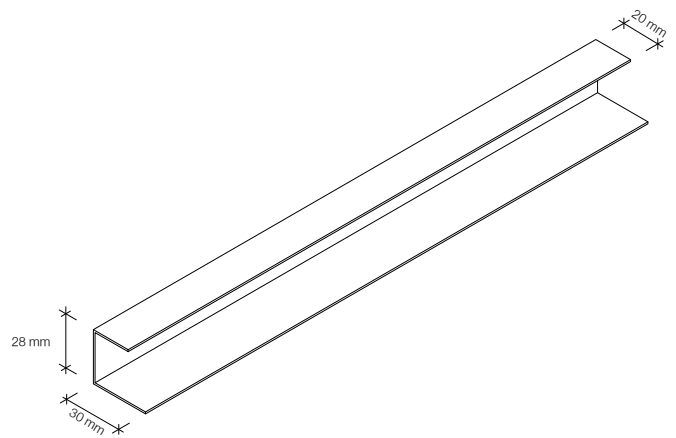

GIB® WALL CLIP

Provides lateral support to both sides of the GIB® H-stud.

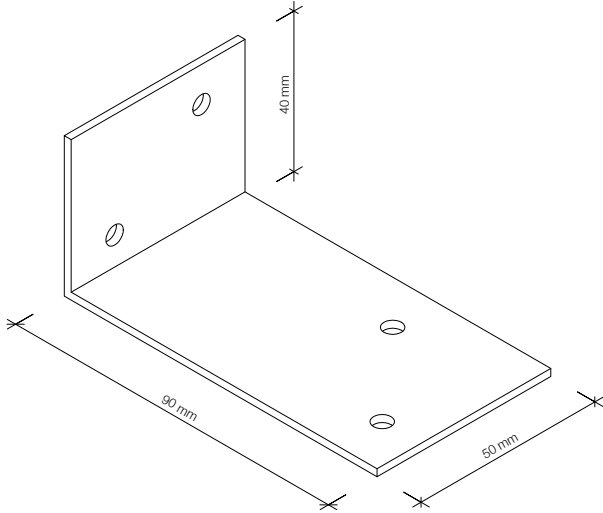

GIB® WALL STRAP

Provides lateral support to the GIB® Rondo® 140 Perimeter Channel at wall ends.

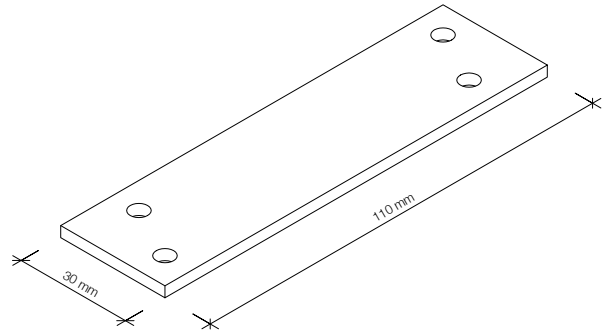

GIB® QUIET TIE®

Provides a structural connection between the frames of double stud walls, whilst maintaining the STC rating of the system.

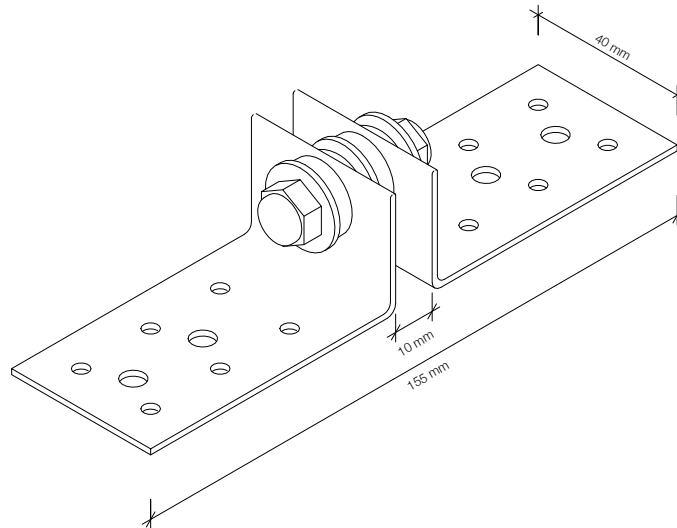

PINK® BATTS® R1.2 GLASS WOOL INSULATION

- Made from over 80% recycled glass.
- Thickness 50mm.
- Nominal total area per pack 17.0m².
- Each section pre-cut to 1220 x 580mm.



PINK® BATTS® BIB R1.8 GLASS WOOL INSULATION

- Made from over 80% recycled glass.
- Thickness 75mm.
- Nominal total area per pack 19.2m².
- Each roll pre-cut to 8000 x 1200mm.



PINK® BATTS® R2.2 GLASS WOOL INSULATION

- Made from over 80% recycled glass.
- Thickness 90mm.
- Nominal total area per pack 13.4m².
- Each section pre-cut to 1140 x 560mm.



PINK® BATTS® SILENCER® GLASS WOOL INSULATION

- Made from over 80% recycled glass.
- Thickness 100mm.
- Nominal total area per pack 12.8m².
- Each section pre-cut to 1140 x 560mm.

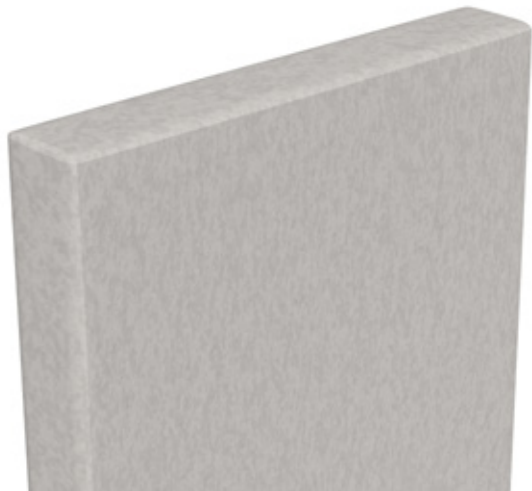

GIB® Quiet Ties® have been designed to provide connection between the studs and plates of double timber frame walls, whilst maintaining the system's published noise control STC/Rw rating.

GIB® Quiet Ties® are not suitable for use with double timber frame wall systems that incorporate a GIB Barrierline® central barrier.

If connections are required to resist a lateral force of 0.5kPa, as specified in New Zealand Building Code Clause B1/VM1, then the recommended spacing is one GIB® Quiet Tie® at no more than 1.8 metres spaced horizontally along the suspended floor wall bottom plate (as illustrated), for an inter-storey height of 3 metres. GIB® Quiet Ties® can also be used at roof level if no other connections exist, such as continuous roofing iron.

When they are required to achieve lateral connection between frames as part of a specific engineering design, the Structural Engineer shall determine the appropriate spacing of GIB® Quiet Ties®. The GIB® Quiet Tie® has a design capacity of 4 kN in tension and 2 kN in compression (compression loads will also be partially absorbed by mineral fibre packing between frames at floor levels).

GIB® Quiet Tie® is distributed by MiTek New Zealand. Fastening instructions are included in the packaging

RECOMMENDED PLACEMENT OF GIB® QUIET TIE®

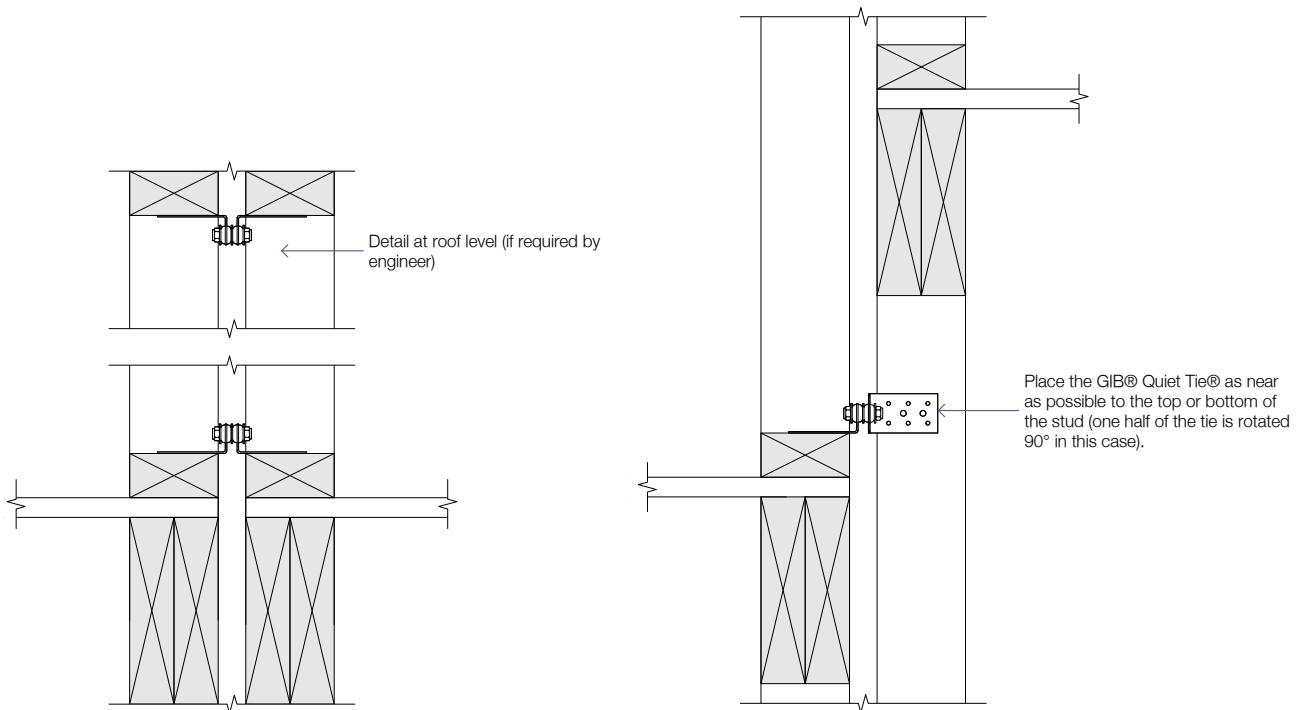

GNS320

GNS321

Acoustic Concerned with sound or the sense of hearing, including how sound behaves within a room or between rooms.

Airborne sound Sound energy transmitted through the air.

ASTM American Society for Testing and Materials.

BIB Building Insulation Blanket.

BMT Bare Metal Thickness. The base metal thickness of light gauge, galvanised steel profiles.

dB An abbreviation for decibel. A decibel is the unit of measure for sound pressure level. A decibel is a tenth of a Bel.

DPC Damp Proof Course. Used to stop the transfer of moisture.

FIIC Field Impact Insulation Class: In essence, an IIC measurement undertaken on a building site.

Flanking Sound transmission to a receiving room by a path other than the building element of interest.

FSTC Field Sound Transmission Class: In essence, a STC measurement undertaken on a building site.

FRR Fire Resistance Rating. The term used to describe the minimum fire resistance of primary and secondary elements as determined in the standard test for fire resistance or in accordance with a specific calculation method verified by experimental data from standard fire resistance tests. It comprises three numbers giving the time in minutes for which each of the criteria (structural adequacy, integrity and insulation) are satisfied. It is always presented in that order expressed as xx/yy/zz.

IIC Impact Insulation Class: A rating for the impact sound insulation capability of a Floor/ceiling system in a laboratory. The measurement range is 100 to 3150Hz. Generally, the higher the rating the better the performance.

Impact sound Sound energy generated by striking a floor or wall surface (e.g. footsteps, closing a door, dropping an object, etc.). This energy becomes structure-borne sound that then re-radiates into neighbouring spaces as audible sound.

ISO Abbreviation for 'International Standards Organisation'.

LB Load bearing. Indicates that the element being referred to can resist a structural load.

Noise Sound that is unwanted by the listener.

Noise control system — intertenancy A building element suitable for use as a separation between two tenancies.

Noise control system — sub-intertenancy A building element suitable for use within a single tenancy.

NLB Non load bearing. Indicates that the element being referred to cannot resist any structural load.

NZBC New Zealand Building Code.

Rw Weighted Sound Reduction Index: A rating of airborne sound reduction through a building element in a laboratory. Rw is an ISO rating and is derived from transmission loss measurements between 100 to 3150Hz. Generally, the higher the rating the better the performance.

Sound A travelling vibration through an elastic medium that may be detected by a hearing system.

STC Sound Transmission Class: A rating of airborne sound reduction through a building element in a laboratory. STC is an ASTM rating and is derived from transmission loss measurements between 125 to 4000Hz. Generally, the higher the rating the better the performance.

Structure-borne sound Sound energy transmitted through a solid (e.g. along joists or service pipes).

Transmission loss The measure of a wall or floor system's ability to attenuate the transfer of sound — specified at each octave or third-octave frequency band.

GIB Noise Control® Systems, September 2017

Winstone Wallboards Ltd accepts no liability if the GIB Noise Control® Systems and junction details are not installed in strict accordance with instructions contained in this publication.

USE ONLY THE CURRENT SPECIFICATION

This publication may be superseded by a new publication. Winstone Wallboards accepts no liability for reliance upon publications that have been superseded. You should check the GIB® website to ensure you are using the current publication. If you are unsure whether this is the current publication, simply call the GIB® Helpline on 0800 100 442.

SUBSTITUTION

GIB Noise Control® Systems have been specifically designed and tested to achieve the listed STC, Rw and FRR stated for each system. To maintain the GIB® Product and System Warranty, all system components detailed in this publication must be used when specifying and installing GIB Noise Control® Systems. You should check the GIB® website to ensure you are using the current publication.

TRADEMARKS

The names GIB®, GIB Fyreline®, GIB Ultraline®, GIB Toughline®, GIB Braceline®/GIB Noiseline®, GIB Aqualine®, GIB Nail®, GIB Tradeset®, GIB Plus 4®, GIB-Cove®, GIB Lite Blue®, GIB Fix®, GIB Quiet Stud®, GIB Rail®, GIB Barrierline®, GIB Soundseal®, GIB Clip®, the colour mauve for GIB Toughline®, the colour blue for GIB Braceline®, the colour pink for GIB Fyreline®, the colour green for GIB Aqualine®, and the shield device are registered trademarks of Fletcher Building Holdings Limited.

COPYRIGHT

Copyright® Winstone Wallboards Ltd 2017. All of the material contained in this brochure, including all text, tables, charts, graphs, drawings, images and diagrams are protected by copyright. These materials may not be reproduced, adapted or transmitted in any form by any process, without the permission of Winstone Wallboards Ltd.

COUNTRY OF ORIGIN

We make GIB® plasterboard in New Zealand*, for New Zealand conditions, giving you 100% certainty.

*Note: GIB Barrierline® plasterboard is manufactured to Winstone Wallboards' specific specification from a reputable overseas manufacturer.

Copyright® Winstone Wallboards Ltd, 2017.



FOR MORE INFORMATION VISIT

gib.co.nz

OR CALL THE GIB® HELPLINE

0800 100 442